



**The House of Parts**  
**Quality Wholesale Distribution Since 1957**

## **2016 Replacement Parts Catalog**



**Aftermarket & OEM Parts**  
**Select Parts 40% ethanol compliant**  
**Flat Rate Shipping with Free Shipping Programs**

**24 Hour Ordering, additional discounts and more:**

**[www.ccdist.com](http://www.ccdist.com)**

# C&C Distributors, Inc.

131 W COLLINS RD  
FORT WAYNE, IN 46825  
PHONE: 260-483-4562  
FAX: 877-682-2985

1517 S. MICHIGAN ST  
SOUTH BEND, IN 46613  
PHONE: 574-233-6667  
FAX: 877-900-9480

## SALES TERMS AND POLICIES

### 1) PAYMENT TERMS

- a. All invoices from the first of the month through the end of the same month are due the 20<sup>th</sup> of the following month. (Statements are run on the first of every month and payment is due by the 20<sup>th</sup> of that month.)
- b. Accounts **PAST DUE 30 DAYS** will be placed on COD status plus \$100 per shipment that will be applied to the past due total.
- c. Accounts **PAST DUE 60 DAYS** will be placed on parts hold status.
- d. Accounts **PAST DUE 90 DAYS** will be notified and collection procedures initiated.
- e. A monthly service charge of 1 ½% will be assessed on all past due accounts.

### 2) RETURN CHARGE

- a. Items ordered in error are eligible for return within **30 DAYS** of purchase subject to a **20% restock fee**. A copy of the original invoice must accompany all returns (or an invoice number) and an RGA provided by C&C. RGA's are obtained through Donna at 800-589-4632 ext 4. Onan, Wisconsin, Honda, and Tecumseh parts are nonreturnable. Whole goods are not eligible for return.
- b. Factory return guidelines apply to the yearly fall or spring program.
- c. All products must be in resalable condition. No used parts will be accepted!

### 3) FREIGHT POLICY

- a. All emergency orders (drop ships) will carry actual shipping cost from the point of origin.
- b. Orders placed by 3 PM Eastern Time will be shipped the same day.
- c. COD customers can avoid the \$10.50 COD charge by using a Visa, MasterCard, or Discover credit card.

### 4) OPEN TERMS & DISCOUNTS

- a. Only accounts with sales higher than \$1000 per year are eligible for credit. All other accounts are cash or credit card only.
- b. Full dealer discounts are only available to dealers that place a yearly plan A or higher spring order or maintain a minimum \$2000 yearly purchase history.

### 5) LOOKING UP PARTS

- a. We recognize the importance of offering parts lookup for wholesale/commercial customers when asked to. We have, and will continue to, provide this service at no charge to our customers. Due to the complex nature of performing the service, we can assume no responsibility for any errors made as a direct result of our efforts. With that in mind, all parts returned as a result of parts lookup errors will be at the customers' expense, i.e., call tags issued will be subject to an \$12.00 charge.

# Table Of Contents

<b>BLADES .....</b>	<b>4</b>
» Mower Blades .....	5
» Edger & Brushcutter Blades.....	31
<b>UNIVERSAL CABLES .....</b>	<b>33</b>
» Throttle, Choke, & Stop Cables.....	34
» Cable Accessories.....	40
<b>GO KART PARTS .....</b>	<b>42</b>
» Throttle Controls.....	43
» Go Kart Throttle & Brake Cables.....	43
» Cable Stops.....	44
» Go Kart Clutches .....	44
» Go Kart Racing Clutches.....	45
» Torq Converter Driver Unit .....	45
» Drive Sprockets .....	45
» Clutch Bushings.....	45
» Drive Sprockets .....	46
» Key Stock.....	46
» Brake Pucks.....	46
» Brake Drum.....	46
» Clutch Collars .....	47
» Brake Band .....	47
» Sprockets .....	47
<b>DRIVE PARTS .....</b>	<b>48</b>
» Drive Gears.....	49
» Driven Discs.....	49
» Friction Drive Discs.....	50
» Hydro Pumps.....	51
» Clutch Cables.....	51
» Control, Brake, Engagement Cables .....	52
<b>WHEELS &amp; TIRES .....</b>	<b>55</b>
» Valve Stems.....	56
» Trailer Tires.....	56
» Valve Stems:.....	56
» Trailer Tires:.....	56
» Wheel assemblies:.....	57
» Wheel Assemblies .....	57
» Rims: .....	59
» Rims .....	59
» Pneumatic Tires.....	60
» Carlisle Tires .....	62



<b>TUBES.....</b>	<b>66</b>
» 4" Tubes.....	67
» 5" Tubes.....	67
» 6" Tubes.....	67
» 7" Tubes.....	67
» 8" Tubes.....	68
» 9" Tubes.....	68
» 10" Tubes .....	68
» 11" Tubes .....	68
» 12" Tubes .....	69
» 20" Tubes .....	69

# Blades



<b>BLADES.....</b>	<b>4</b>
» <i>MOWER BLADES.....</i>	<i>5</i>
» <i>AYP.....</i>	<i>5</i>
» <i>BAD BOY.....</i>	<i>8</i>
» <i>BOBCAT.....</i>	<i>9</i>
» <i>COUNTRY CLIPPER.....</i>	<i>9</i>
» <i>DIXON.....</i>	<i>10</i>
» <i>EXMARK.....</i>	<i>10</i>
» <i>FERRIS.....</i>	<i>12</i>
» <i>GRASSHOPPER.....</i>	<i>12</i>
» <i>GRAVELY.....</i>	<i>12</i>
» <i>HONDA.....</i>	<i>13</i>
» <i>HUSTLER.....</i>	<i>13</i>
» <i>JOHN DEERE.....</i>	<i>14</i>
» <i>KUBOTA.....</i>	<i>16</i>
» <i>MTD.....</i>	<i>17</i>
» <i>MURRAY.....</i>	<i>22</i>
» <i>NOMA.....</i>	<i>24</i>
» <i>SCAG.....</i>	<i>24</i>
» <i>SIMPLICITY.....</i>	<i>25</i>
» <i>SNAPPER.....</i>	<i>26</i>
» <i>TORO.....</i>	<i>27</i>
» <i>WALKER.....</i>	<i>29</i>
» <i>WOODS.....</i>	<i>30</i>
<b>EDGER &amp; BRUSHCUTTER BLADES.....</b>	<b>31</b>

Fits OEM	Length	Center Hole Diam.	Outside Hole Diam.	Center To Center	Width	Thick-ness	Application
----------	--------	-------------------	--------------------	------------------	-------	------------	-------------









# AYP







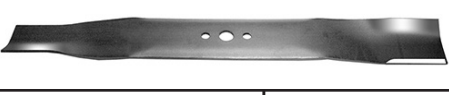

	163819 152443	15-1/2" 393.7mm	5 point star			2-1/4" 57.2mm	.160" 4mm	(3) blades for 46" cut. Fits AYP, Sears, Husky and Poulan.
<b>ORDER #:</b> 6437	<b>\$13.45</b>							
	159705 170698 176084	15-1/2" 393.7mm	5 point star			2-1/4" 57.1mm	.160" 4.8mm	High lift blade. (3) blades for 46" cut. Fits AYP, Sears, Husqvarna & Poulan.
<b>ORDER #:</b> 6495	<b>\$13.45</b>							
	25034 25034R	15-3/8" 390.5mm	3/8" 9.5mm			2-1/4" 57.2mm	.187" 4.8mm	(3) blades for 44" cut
<b>ORDER #:</b> 2162	<b>\$17.21</b>							
	130652	15-3/8" 390.5mm	5 point star			2-1/4" 57.2mm	.160" 4.1mm	(3) blades for 44" cut Hi Performance
<b>ORDER #:</b> 6205	<b>\$14.95</b>							
	157033	15-9/16" 395mm	5 point star			2-1/4" 57.2mm	.187" 4.8mm	(3) blades for 46" cut. Fits AYP, Sears, Husky and Poulan. (Heavy Duty)
<b>ORDER #:</b> 9170	<b>\$13.45</b>							
	506-96-63-01	16-3/16" 411.2mm	.972" 24.69mm	.323" 8.2mm	1.899" 48.23mm	2" 50.8mm	.150" 3.8mm	(3) blades for 48" cut.
<b>ORDER #:</b> 6489	<b>\$12.60</b>							
	173920 180054	16-3/4" 425.5mm	5 point star			2-1/2" 63.5mm	.204" 5.2mm	(3) blades for 48" cut. High Lift
<b>ORDER #:</b> 9907	<b>\$13.95</b>							
	25322 9485H 25322R	16-5/8" 422.3mm	1-1/4" 31.8mm	15/32" 11.9mm	3" 76.2mm	2-1/2" 63.5mm	.187" 4.8mm	(3) blades for 48" cut
<b>ORDER #:</b> 2690	<b>\$12.89</b>							
	173921	16-5/8" 422.3mm	5 point star			2-1/2" 63.5mm	.204" 5.2mm	(3) blades for 48" cut.
<b>ORDER #:</b> 10377	<b>\$13.95</b>							
		16-5/8" 422.3mm	5 point star			2-1/2" 63.5mm	.204" 5.2mm	Commercial Mulcher (3) blades for a 48" cut.
<b>ORDER #:</b> 12475	<b>\$13.95</b>							

# BLADES

## Mower Blades



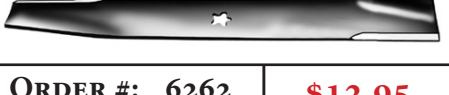

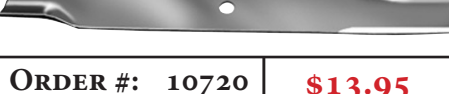

		Fits OEM	Length	Center Hole Diam.	Outside Hole Diam.	Center To Center	Width	Thick-ness	Application
		137380	17-3/8"	5 point			2-1/4"	.160"	(3) blades for 50" cut front engine lawn tractor.
<b>ORDER #:</b> 6196	<b>\$14.95</b>		441.3mm	star			57.2mm	4.1mm	
		137380	17-3/8"	5 point			2-1/4"	.187"	(3) blades for 50" cut. (heavy Duty). Also fits Poulan.
<b>ORDER #:</b> 6264	<b>\$14.95</b>		441.3mm	star			57.2mm	4.8mm	
			18-1/2"	5 point			3"	.187"	Commercial Mulcher (3) blades for a 54" cut.
<b>ORDER #:</b> 12121	<b>\$19.55</b>		469.9mm	star			76.2mm	4.8mm	
		187254 532-187256	18-1/2"	5 point			2-1/2"	.204"	High Lift Bagging Blade (3) blades for 54" cut
<b>ORDER #:</b> 14459	<b>\$15.95</b>		470mm	star			63.5mm	5.2mm	
		25645 98111 71285	18-3/16"	3/8"			2-1/2"	.134"	(2) blades for 36" cut
<b>ORDER #:</b> 3358	<b>\$8.79</b>		462mm	9.5mm			63.5mm	3.4mm	
		187254	18-3/8"	5 point			3"	.187"	fits Craftsman, Husqvarna and Poulan Pro. (3) blades for 54" cut Standard Lift Blade.
<b>ORDER #:</b> 11180	<b>\$15.95</b>		466.7mm	star			76.2mm	4.8mm	
		121263x	19-1/4"	3/8"			2-1/4"	.187"	(2) blades for 38" cut
<b>ORDER #:</b> 6105	<b>\$12.95</b>		489mm	9.5mm			57.2mm	4.8mm	
		193957	19-1/4"	5 point			2-1/4"	.150"	Fits Sears Craftsman rider. 3 in 1 blade. (2) blades for a 38" cut.
<b>ORDER #:</b> 12240	<b>\$12.95</b>		488.95mm	star			57.2mm	3.8mm	
		106634 25036 25036R	19-11/32"	3/8"			2-1/4"	.150"	(2) blades 15-3392
<b>ORDER #:</b> 3392	<b>\$13.67</b>		491.3mm	9.5mm			57.2mm	3.8mm	
		138497 127842	19-5/16"	5 point			2-1/4"	.150"	(2) blades for 38" cut Standard Lift Blade
<b>ORDER #:</b> 6124	<b>\$12.95</b>		490.54mm	star			57.2mm	3.8mm	
		134148	19-5/16"	5 point			2-1/4"	.134"	(2) blades for 38" cut front engine rider. Mulching Blade
<b>ORDER #:</b> 6190	<b>\$12.95</b>		498.5mm	star			57.2mm	3.4mm	

		Fits OEM	Length	Center Hole Diam.	Outside Hole Diam.	Center To Center	Width	Thick-ness	Application
		56400 8020 56400R	20"	5/8"			2-1/2"	.134"	Low lift blade. Fits 20" walk behind
<b>ORDER #:</b> 1043	<b>\$11.26</b>		508mm	15.9mm			63.5mm	3.4mm	
		850972	20"	5/8"	3/8"	1-7/8"	2-1/2"	.134"	For 20" walk behind
<b>ORDER #:</b> 6037	<b>\$10.79</b>		508mm	15.9mm	9.5mm	47.6mm	63.5mm	3.4mm	
		752233 145106	20"	5/8"	3/8"	1-7/8"	2-1/4"	.134"	Mulching Blade Fits Craftsman 20" walk behind mowers.
<b>ORDER #:</b> 6235	<b>\$11.26</b>		508mm	15.9mm	9.5mm	47.6mm	57.2mm	3.4mm	
		139775	21-1/16"	5 point star			2-1/4"	.150"	Fits Sears Craftsman rider. (2) blades for a 42" cut. 3 in 1 blade
<b>ORDER #:</b> 12563	<b>\$12.95</b>		534mm				57.2mm	3.8mm	
		56401 8021	21-3/4"	5/8"			2-1/2"	.150"	Medium lift blade. Fits 22" walk behind
<b>ORDER #:</b> 1044	<b>\$13.09</b>		553.5mm	15.9mm			63.5mm	3.8mm	
		850973	21-5/8"	5/8"	3/8"	1-7/8"	2-1/2"	.150"	For 22" walk behind
<b>ORDER #:</b> 6038	<b>\$13.09</b>		549.3mm	15.9mm	9.5mm	47.6mm	63.5mm	3.8mm	
		138971 138498 127843	21"	5 point star			2-1/4"	.150"	(2) blades for 42" cut
<b>ORDER #:</b> 6125	<b>\$12.95</b>		533.4mm				57.2mm	3.8mm	
		134149	21"	5 point star			2-1/4"	.134"	(2) blades for 42" cut front engine rider Mulching Blade
<b>ORDER #:</b> 6189	<b>\$12.95</b>		533.4mm				57.2mm	3.4mm	
		134149	21"	5 point star			2-1/4"	.187"	(2) blades for 42" cut (Heavy Duty). Also fits Poulan.
<b>ORDER #:</b> 6262	<b>\$12.95</b>		533.4mm				57.2mm	4.8mm	
		159267 532-40-67-12 406712 165833 175064 189028	21"	5/8"	3/8"	1-7/8"	2-1/4"	.134"	Blade for a 21" walkbehind mower. Mulching Blade
<b>ORDER #:</b> 9810	<b>\$12.45</b>		533.4mm	15.8mm	9.5mm		57.2mm	3.4mm	
		539-10-17-33	21"	5/8"			2-1/2"	.204"	(3) blades for a 61" cut.
<b>ORDER #:</b> 10720	<b>\$13.95</b>		533.4mm	15.9mm			63.5mm	5.2mm	



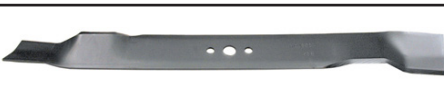

# BLADES

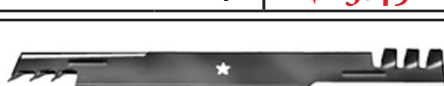
## Mower Blades



		Fits OEM	Length	Center Hole Diam.	Outside Hole Diam.	Center To Center	Width	Thick-ness	Application
		539-113312	21"	5 point			2-1/2"	.204"	EZ-Series, 6124 model (3) blades for a 61" cut.
ORDER #:	12125		533.4mm	star			63.5mm	5.2mm	
			21"	5 point			2-1/2"	.187"	Commercial Mulcher
ORDER #:	6422	533.4mm	star			63.5mm	4.8mm		
		406713 192682 157101 335256 114886 141114	22"	5/8"	3/8"	1-7/8"	2-1/4"	.134"	Blade for 22" cut, side discharge mulching mower. Fits models HW706D, HW906D, HWRBSP22525A, and more.
ORDER #:	6236		558.8mm	15.9mm	9.5mm	47.6mm	57.2mm	3.4mm	
		420463 421825	22"	5 point			2-1/2"	.134"	Fits Craftsman/Husqvarna. 22" Walk behind mowers.
ORDER #:	13023		558.8mm	star			63.5mm	3.4mm	
		405380	23"	5 point			2-3/4"	.150"	Fits 2007 models (2) blades for a 46" cut. Standard Lift Blade
ORDER #:	12242		584.2mm	star			69.9mm	3.8mm	
		403107	23"	5 point			2-1/4"	.150"	Commercial Mulcher (2) blades for a 46" cut.
ORDER #:	12721		584.2mm	star			57.2mm	3.8mm	

# BAD BOY

			16-1/2"	5/8"			2-1/2"	.204"	Commercial Mulcher
ORDER #:	6300	419.1mm	15.8mm			63.5mm	5.2mm		
			18"	5/8"			2-1/2"	.204"	Commercial Mulcher
ORDER #:	6294	457.2mm	15.8mm			63.5mm	5.2mm		
		038-6060-00 038-6050-00 038-2007-00	20-1/2"	5/8"			2-1/2"	.204"	Notched High Lift blade. (3) blades for a 60" cut.
ORDER #:	6083		520.7mm	15.9mm			63.5mm	5.2mm	
			20-1/2"	5/8"			2-1/2"	.204"	Commercial Mulcher
ORDER #:	6303	520.7mm	15.8mm			63.5mm	5.2mm		

		Fits OEM	Length	Center Hole Diam.	Outside Hole Diam.	Center To Center	Width	Thick-ness	Application
		038-7202-00	24"	5/8"			3"	.240"	(3) blades for 72" cut. (Heavy Duty)
<b>ORDER #:</b> 6833			609.6mm	15.9mm	76.2mm	6.1mm	<b>\$16.78</b>		

## BOBCAT





		038-4820-00	16-1/4"	5/8"	11/32"	1-5/8"	2-1/2"	.240"	(Heavy Duty) (2) blades for 32" cut. (3) blades for 48" cut.
<b>ORDER #:</b> 2172			412.8mm	15.9mm	8.7mm	41.3mm	63.5mm	6.1mm	
			16-1/4"	5/8"			2-1/2"	.204"	Commercial Mulcher
<b>ORDER #:</b> 6296		412.8mm	15.8mm	63.5mm	5.2mm	<b>\$13.75</b>			
		038-3000-00	18"	5/8"			2-1/2"	.240"	(Heavy Duty) (2) blades for 36" cut (3) blades for 52" cut
<b>ORDER #:</b> 2173			457.2mm	15.9mm	63.5mm	6.1mm	<b>\$15.69</b>		
		112111-02	18"	5/8"			2-1/2"	.204"	(2) blades for 36" cut
<b>ORDER #:</b> 3401			457.2mm	15.8mm	63.5mm	5.2mm	<b>\$11.24</b>		
		42180B	21"	5/8"			2-1/2"	.240"	(Heavy Duty) (3) blades for 61" cut
<b>ORDER #:</b> 2174			533.4mm	15.8mm	63.5mm	6.1mm	<b>\$15.51</b>		
		112111-03	21"	5/8"			2-1/2"	.240"	(3) blades for 61" cut
<b>ORDER #:</b> 3402			533.4mm	15.8mm	57.2mm	6.1mm	<b>\$13.26</b>		
			21"	5/8"			2-1/2"	.204"	Commercial Mulcher
<b>ORDER #:</b> 6299		533.4mm	15.8mm	63.5mm	5.2mm	<b>\$20.50</b>			

## COUNTRY CLIPPER



		320242	21"	1/2"			2-1/2"	.240"	(Heavy Duty) (3) blades for 61" cut Standard lift
<b>ORDER #:</b> 6167			533.4mm	12.7mm	63.5mm	6.1mm	<b>\$18.20</b>		











	Fits OEM	Length	Center Hole Diam.	Outside Hole Diam.	Center To Center	Width	Thick-ness	Application
		21" 533.4mm	1/2" 12.7mm			2-1/2" 63.5mm	.204" 5.2mm	Commercial Mulcher
<b>ORDER #:</b> 6311								<b>\$18.35</b>

## DIXON

	6236	14-1/2" 368.3mm	11/16" 17.5mm			2-1/2" 63.5mm	.187" 4.8mm	For "ZERO TURN" models 428 & 429 (3) blades for 42" cut Low lift
<b>ORDER #:</b> 6086								<b>\$19.04</b>
	8688	14-1/2" 368.3mm	11/16" 17.5mm			2-1/2" 63.5mm	.187" 4.8mm	For "ZERO TURN" models 428 & 429 (3) blades for 42" cut High lift
<b>ORDER #:</b> 6087								<b>\$19.04</b>
	9444	17" 431.4mm	11/16" 17.9mm			2-1/2" 63.5mm	.187" 4.8mm	(3) blades for 50" cut. High lift.
<b>ORDER #:</b> 6766								<b>\$19.04</b>
	1351	18-7/16" 468.3mm	3/4" 19.1mm	13/32" 10.3mm	2-9/16" 65.1mm	2-3/4" 69.9mm	.187" 4.8mm	For ZTR 361 W/Catcher
<b>ORDER #:</b> 6084								<b>\$20.28</b>
	9383	20-1/2" 520.7mm	5/8" 15.9mm			2-1/2" 63.5mm	.240" 6.1mm	(3) blades for 60" cut
<b>ORDER #:</b> 6180								<b>\$20.95</b>

## EXMARK

	120-99500-03 116-6358-03	15.4" 391.1mm	.660" 16.76mm			2-1/4" 57.2mm	3.97mm	Commercial Mulcher (2) blades for 30" cut Fits TimeMaster .150" 20199 & 20200. Model ECKA30
<b>ORDER #:</b> 14420								<b>\$19.37</b>
	1-323515	16-1/4" 412.8mm	5/8" 15.8mm			2-1/2" 63.5mm	.204" 5.2mm	(3) blades for 48" cut. Fits Turf Tracer, HP Metro, & Viking units.
<b>ORDER #:</b> 9487								<b>\$15.96</b>
	103-6401	16-1/4" 412.7mm	15/16" 23.8mm			2-1/2" 63.5mm	.204" 5.2mm	Notched Air Foil Blade. (3) blades for 48" cut. High Lift Blade
<b>ORDER #:</b> 11231								<b>\$15.00</b>

		Fits OEM	Length	Center Hole Diam.	Outside Hole Diam.	Center To Center	Width	Thick-ness	Application
		1-303527	18"	5/8"			2-1/2"	.204"	(3) blades for 52" cut. High Lift Blade . Fits Lazer Z units.
<b>ORDER #:</b> 10071	<b>\$18.16</b>		457.2mm	15.9mm			63.5mm	5.2mm	
		103-6402	18"	15/16"			2-1/2"	.204"	High Lift Blade (2) blades for 36" cut. (3) blades for 52" cut.
<b>ORDER #:</b> 11495	<b>\$14.59</b>		457.2mm	23.8mm			63.5mm	5.2mm	
		1-603283	20-1/2"	1/2"			2-1/2"	.204"	Std. high lift for models Explorer, Explorer II, Turf Ranger & Turf Tracer. (3) blades for 60" cut.
<b>ORDER #:</b> 6250	<b>\$17.21</b>		520.7mm	12.7mm			63.5mm	5.2mm	
		103-2530	20-1/2"	5/8"			2-1/2"	.204"	Notched High Lift blade. (3) blades for a 60" cut.
<b>ORDER #:</b> 10667	<b>\$16.10</b>		520.7mm	15.9mm			63.5mm	5.2mm	
		103-6403	20-1/2"	15/16"			2-1/2"	.204"	High lift blade (3) blades for 60" cut. Notched Air lift blade.
<b>ORDER #:</b> 11224	<b>\$15.00</b>		520.7mm	23.8mm			63.5mm	5.2mm	
		103-6393	20-1/2"	15/16"			3"	.204"	Fits Lazer model. (3) blades for 60" cut. Mulching Blade
<b>ORDER #:</b> 11242	<b>\$15.13</b>		520.7mm	23.8mm			76.2mm	5.2mm	
		103-6403	20-1/2"	15/16"			2-1/2"	.240"	(3) blades for 60" cut. Notched High lift blade
<b>ORDER #:</b> 11248	<b>\$15.00</b>		520.7mm	23.8mm			63.5mm	6.1mm	
		91-2256-03 14-9419 75-9420	20-15/16"	7/16"	3/8"	2-7/16"	2-9/16"	.134"	Blade only Fits Toro 21" Recycler without saddle
<b>ORDER #:</b> 6256	<b>\$10.34</b>		531.9mm	11.1mm	9.5mm	61.9mm	65.1mm	3.4mm	
		103-8244	20-3/4"	15/16"			3"	.204"	High Lift Blade (3) blades for a 60" cut.
<b>ORDER #:</b> 12005	<b>\$20.50</b>		527.1mm	23.8mm			76.2mm	5.2mm	
		103-6404	24-1/2"	15/16"			3"	.204"	Fits 72" Lazer model. (3) blades for 72" cut. Air Foil Lift Blade.
<b>ORDER #:</b> 11229	<b>\$19.13</b>		622.3mm	23.8mm			76.2mm	5.2mm	
		1-643006 103-2531	24-13/32"	5/8"			3"	.204"	(3) blades for 72" cut. Fits model Lazer Z.
<b>ORDER #:</b> 6481	<b>\$20.36</b>		619.9mm	15.9mm			76.2mm	5.2mm	

Fits OEM	Length	Center Hole Diam.	Outside Hole Diam.	Center To Center	Width	Thick-ness	Application
----------	--------	-------------------	--------------------	------------------	-------	------------	-------------

## FERRIS

	5020842 1520842	21" 533.4mm	5/8" 15.9mm			2-1/2" 63.5mm	.240" 6.1mm	(3) blades for 61" cut. Fits Mid-Mount "Zero Turn".
<b>ORDER #:</b> 9987	<b>\$17.55</b>							

## GRASSHOPPER

	320237 320239	18" 457.2mm	1/2" 12.7mm			2" 50.8mm	.204" 5.2mm	Takes (2) 15-3380 & (1) 15-3378 for 48" cut. (3) blades for 52" cut High lift
<b>ORDER #:</b> 3380	<b>\$15.85</b>							

		18" 457.2mm	1/2" 12.7mm			2-1/2" 63.5mm	.204" 5.2mm	Commercial Mulcher
<b>ORDER #:</b> 6309	<b>\$15.25</b>							

	320239	18" 457.2mm	1/2" 12.7mm			2-1/2" 63.5mm	.240" 6.1mm	(3) blades for 52" cut
<b>ORDER #:</b> 13463	<b>\$15.85</b>							

	320243	21" 533.4mm	1/2" 12.7mm			2" 50.8mm	.204" 5.2mm	(3) blades for 61" cut High lift
<b>ORDER #:</b> 3424	<b>\$18.35</b>							

	320243	21" 533.4mm	1/2" 12.7mm			2-1/2" 63.5mm	.240" 6.1mm	(Heavy Duty) (3) blades for 61" cut High lift
<b>ORDER #:</b> 6168	<b>\$18.35</b>							





## GRAVELY

	9229	17" 431.8mm	5/8" 15.8mm			2" 50.8mm	.204" 5.2mm	Std. deck (3) blades for 50" cut
<b>ORDER #:</b> 1066	<b>\$19.32</b>							

	8779251 87792 046998	17" 433.4mm	5/8" 15.9mm			2-1/2" 63.5mm	.240" 6.1mm	(3) blades for 50" cut "ZERO TURN" High lift
<b>ORDER #:</b> 6181	<b>\$18.85</b>							

Fits OEM	Length	Center Hole Diam.	Outside Hole Diam.	Center To Center	Width	Thick-ness	Application
----------	--------	-------------------	--------------------	------------------	-------	------------	-------------

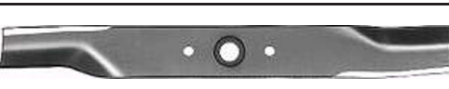
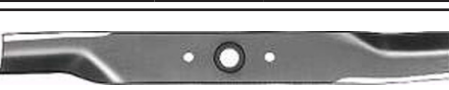
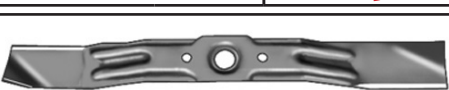
# HONDA









	72531-758-L00	19-1/2" 495.3mm	.630" 16mm			2-3/4" 69.9mm	.187" 4.8mm	Fits 38" deck models 4514, 4518, 3013 & 4013 takes (1) 15-6150 & (1) 15-6151 Left hand blade
<b>ORDER #:</b> 6150	<b>\$16.44</b>							
	72511-V63-000 72511-VE1-020 code 4513511	20-5/16" 532mm	.804" 20mm	13/32" 10.3mm	3-15/32" 88.1mm	2-1/4" 57.2mm	.134" 3.4mm	Fits 21" walkbehind. Models HRB215, HRM215 High Lift. Lower Blade.
<b>ORDER #:</b> 6428	<b>\$12.98</b>							
	72511-VA2-690 72511-960-004 code #2801595	20-7/8" 530.2mm	.845" 21.5mm	.415" 10.5mm	3-7/16" 87.3mm	2-1/4" 57.2mm	.150" 3.8mm	Fits HR 214, HRA 214 and HRA 216
<b>ORDER #:</b> 2160	<b>\$12.98</b>							
	72511-VA4-641 code #3504230	20-7/8" 530.2mm	.845" 21.5mm	.415" 10.5mm	3-7/16" 87.3mm	2-1/4" 57.2mm	.150" 3.8mm	Fits all Honda 21" cut from 1981-1991, 21" Mulcher
<b>ORDER #:</b> 6092	<b>\$12.98</b>							
	72511-VE2-000 code 4010609	20-7/8" 530.2mm	.830" 27.3mm	13/32" 10.3mm	3-15/32" 88.1mm	2-1/4" 57.2mm	.095" 2.4mm	Lower blade. Use with our 15-6430 upper blade. Fits 21" walkbehind.
<b>ORDER #:</b> 6431	<b>\$12.98</b>							
	72511-VK6-000	21-1/4" 539.75mm	.804" 20mm	.415" 10.5mm	3.373" 88mm	4-1/4" 108mm	.117" 3.0mm	Fits 21" Honda mower model HRC216K2. lower blade.
<b>ORDER #:</b> 12615	<b>\$12.98</b>							
	72531-VH7-000 code 4513529	21" 533.4mm	1-17/64" 32.1mm	13-32" 10.3mm	3-15/32" 88.1mm	2-5/8" 66.7mm	.095" 2.4mm	Upper blade 15-6428 Lower blade 15-6431 Fits 21" walkbehind.
<b>ORDER #:</b> 6430	<b>\$12.98</b>							



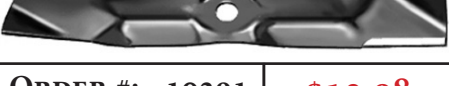



# HUSTLER

	782516	21" 533.4mm	5/8" 15.8mm			3" 76.2mm	.240" 6.1mm	"Does not fit RX7 decks". (3) blades for 60" cut. Fits models Hustler Z, Super Z & Short Cut.
<b>ORDER #:</b> 10373	<b>\$19.95</b>							

Fits OEM	Length	Center Hole Diam.	Outside Hole Diam.	Center To Center	Width	Thick-ness	Application
----------	--------	-------------------	--------------------	------------------	-------	------------	-------------

# JOHN DEERE



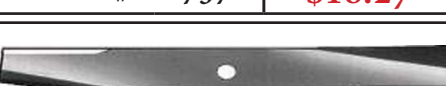
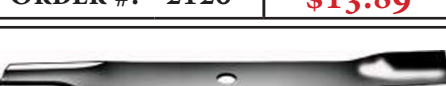
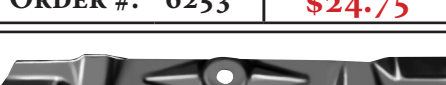
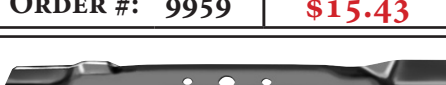
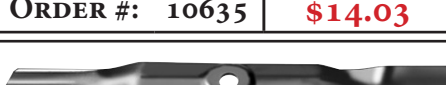





	M115495	16-5/8" 422.3mm	13/16" 20.6mm		2-1/2" 63.5mm	.204" 5.2mm	(3) blades for 48" cut
<b>ORDER #:</b> 6206	<b>\$15.50</b>						
	M127466 M41967 AM31100	16" 406.4mm	11/16" 17.5mm		2" 50.8mm	.187" 4.8mm	(3) blades for 48" cut Model 300
<b>ORDER #:</b> 1127	<b>\$17.95</b>						
	M86209 AM39966	17-3/16" 436.6mm	11/16" 17.5mm		2-1/2" 63.5mm	.204" 5.2mm	(3) blades for 50" cut (Old No. 3383)
<b>ORDER #:</b> 6012	<b>\$16.73</b>						
	M127500 M145476	17" 431.8mm	.800" 20.6mm		2-1/2" 63.5mm	.204" 5.2mm	Fits 48C decks. Since 1999. (3) blades per unit 48" cut.
<b>ORDER #:</b> 10291	<b>\$12.98</b>						
	GX20250	17" 431.8mm	.675" 17.1mm		2-1/2" 63.5mm	.150" 3.8mm	Fits L120 & L130 series riders. (3) Blades for 48" cut.
<b>ORDER #:</b> 10634	<b>\$12.63</b>						
	GX21784 GY20852	17" 431.8	7 point star		2-3/4" 69.8mm	.160" 4.0mm	3 in 1 blade. (3) blades for a 48" cut. Fits model 145, 155C riders.
<b>ORDER #:</b> 11595	<b>\$14.16</b>						
	M127673 M145476 M127500	17" 431.8mm	.800" 20.3mm		2-1/2" 76.2mm	.204" 5.2mm	Commercial Mulcher (3) blades for a 48" cut.
<b>ORDER #:</b> 12821	<b>\$12.98</b>						
	GX20250	17" 431.8mm	.675" 17.1mm		2-1/2" 63.5mm	.160" 4.0mm	Commercial Mulcher (3) Blades for 48" cut
<b>ORDER #:</b> 12920	<b>\$12.63</b>						
	M115496	18-5/8" 473.1mm	13/16" 20.6mm		2-1/2" 63.5mm	.204" 5.2mm	(3) blades for 54" cut
<b>ORDER #:</b> 6192	<b>\$12.59</b>						
		18-5/8" 473.1mm	13/16" 20.6mm		2-1/2" 63.5mm	.204" 5.2mm	Commercial Mulcher
<b>ORDER #:</b> 6315	<b>\$12.59</b>						

		Fits OEM	Length	Center Hole Diam.	Outside Hole Diam.	Center To Center	Width	Thick-ness	Application
	M143520	18-7/8" 479mm	.800" 20.6mm				2-3/4" 69.9mm	.204" 5.2mm	(3) blades for a 54" cut.
<b>ORDER #:</b> 10292	<b>\$16.77</b>								
	M83459	19-1/2" 495.3mm	11/16" 17.5mm				3" 76.2mm	.204" 5.2mm	(2) blades for 38" cut Fits model SX-38 High Lift
<b>ORDER #:</b> 845	<b>\$18.27</b>								
	AM100946 M82408	19-1/2" 495.3mm	11/16" 17.5mm				2-1/2" 63.5mm	.204" 5.2mm	(2) blades for 38" cut for riders
<b>ORDER #:</b> 6011	<b>\$17.95</b>								
	M112991	19-1/2" 495.3mm	11/16" 17.5mm				2-1/2" 63.5mm	.204" 5.2mm	(2) blades for 38" cut Mulching Blade
<b>ORDER #:</b> 6186	<b>\$15.75</b>								
		19-1/2" 495.3mm	11/16" 17.5mm				2-1/2" 63.5mm	.204" 5.2mm	Commercial Mulcher
<b>ORDER #:</b> 6421	<b>\$31.51</b>								
	M84472	19-1/2" 495.3mm	11/16" 17.5mm				3" 76.2mm	.204" 5.2mm	(2) blades for 38" cut Fits models SX38.
<b>ORDER #:</b> 6737	<b>\$18.27</b>								
	M112847 M48452 AM35557	20-1/2" 520.7mm	25/32" 19.8mm				2" 50.8mm	.187" 4.8mm	(3) blades for 60" cut Model 400 & WH-D-250
<b>ORDER #:</b> 2120	<b>\$13.89</b>								
	M87622 M141785	20-1/2" 520.7mm	29/32" 23mm				2-1/2" 63.5mm	.313" 8mm	(3) blades for 60" cut
<b>ORDER #:</b> 6253	<b>\$24.75</b>								
	M145969 M139802	21-15/32" 545.3mm	11/16" 17.5mm				2-1/2" 63.5mm	.160" 4.1mm	(2) blades for 42" cut. Mulching Blade Fits Scott Yard Tractor.
<b>ORDER #:</b> 9959	<b>\$15.43</b>								
	GX20249	21-27/64" 544.1mm	.675" 17.1mm	13/32" 103.mm			2-1/2" 63.5mm	.160" 4.0mm	Fits L100 & L110 series riders. (2) Blades for 42"cut. Also fits Sabre and Scotts mowers.
<b>ORDER #:</b> 10635	<b>\$14.03</b>								
	M148613 M139976	21-3/8" 542.9mm	13/16" 20.6mm				2-1/2" 63.5mm	.203" 5.2mm	(2) blades for 42" cut model GT225 (3) blades for 60" cut. Fits new style decks from 1999
<b>ORDER #:</b> 10074	<b>\$17.09</b>								

# BLADES

## Mower Blades











	Fits OEM	Length	Center Hole Diam.	Outside Hole Diam.	Center To Center	Width	Thick-ness	Application
	GX22151	21-3/8"	7 point			2-3/4"	.155"	3 in 1 blade. (2) blades for a 42" cut. Fits 102,115,125,135 riders.
ORDER #: 11593		542.9mm	star			69.8mm	3.9mm	
	GX22151	21-3/8"	7 point			2-3/4"	.160"	Commercial Mulcher 3 in 1 blade. (2) blades for a 42" cut. Fits 102,115,125,135 riders.
ORDER #: 11594		542.9mm	star			69.8mm	4.0mm	
	M154061	21-3/8"	7 point			2-3/4"	.204"	Heavy Duty Blade. Fits models 102, 115, 125 & 135. 42" Riders (2) blades for a 42" cut.
ORDER #: 12380		542.9mm	star			69.8mm	5.2mm	
	M128485 M133381	21"	29/32"			2-1/2"	.313"	(3) blades for 60" cut. Fits the 7-Iron Deck.
ORDER #: 6479		533.4mm	23mm			63.5mm	8mm	
	GC00344	21"	3/8"	.480"	2"	2-3/4"	.125"	Fits 21" steel decks. Walkbehind mowers. Mulching Blade
ORDER #: 10458		533.4mm	9.5mm	12.3mm	50.8mm	69.9mm	3.2mm	
	M83363 AM102401	24-15/16"	29/32"			2-1/2"	.313"	(3) blades for 72" cut 9/16" Lift
ORDER #: 6252		612.4mm	23mm			63.5mm	8mm	
	M141786 M80783	24-15/16"	29/32"			2-1/2"	.313"	(3) blades for 72" cut 1" Lift
ORDER #: 6255		612.4mm	23mm			63.5mm	8mm	
	TCU15882	25"	.900"			3"	.250"	Hi-Lift Blade (2) blades for a 38" cut.
ORDER #: 12643		635mm	22.8mm			76.2mm	6.35mm	
	M89454 AM101538	29-1/2"	11/16"			2-1/2"	.204"	For 30" deck mowers. Regular lift.
ORDER #: 6328		749.3mm	17.5mm			63.5mm	5.2mm	

# KUBOTA

	K5647-3433 76539-34330 K5649-3434	20-1/2"	1-1/8"			2-1/2"	.240"	(3) blades for 60" cut. Fits tractor models B2150, B1750, B7100HSD, B1550, FZ2100, FZ2400, G1900 & G2000 with deck models:RC60-21B, RC60 -71B, 60B, 60F221 & 60GO
ORDER #: 6209		520.7mm	28.6mm			63.5mm	6.1mm	

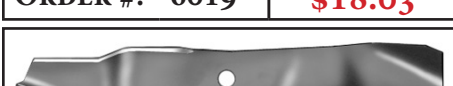
		Fits OEM	Length	Center Hole Diam.	Outside Hole Diam.	Center To Center	Width	Thick-ness	Application
		76539-34330	20-1/2"	1-1/8"			2-1/2"	.240"	Commercial Mulcher Fits models B2150, B1750 B7100HSD, B1550, FZ2100, FZ2400, G1900, G2000. (3) blades for a 60" cut.
<b>ORDER #:</b> 11558	<b>\$19.30</b>		520.7mm	28.6mm			63.5mm	6.1mm	







# MTD



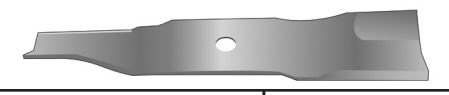

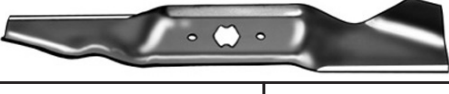
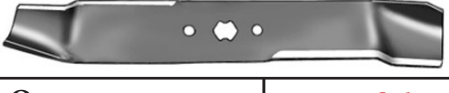

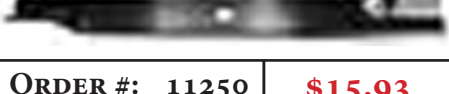
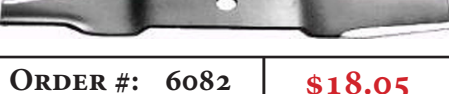

		759-3848 759-3844 477-598-R3 490-471-R1	11"	3/4"			2-1/2"	.204"	1968 to 1973 models Takes (2) 15-6075 & (1) 15-6077 for 42" cut
<b>ORDER #:</b> 6075	<b>\$15.03</b>		279.4mm	19.1mm			63.5mm	5.2mm	
		942-0543 742-0543	14-13/16"	"H"	5/16"	2-1/2"	3"	.125"	Takes (1) 15-1022 & (2) 15-1021 for 46" cut
<b>ORDER #:</b> 1022	<b>\$17.67</b>		376.2mm	Pattern	7.9mm	63.5mm	76.2mm	3.2mm	
		942-04126 742-04126 742-04124 942-04124 942-0612 742-0612	14-13/16"	"H"	3/8"	2-1/2"	2-1/2"	.150"	Takes (1) 15-1030 & (2) 15-1029 for 46" cut. Fits models 600 & 800 series. 1997 & after, side discharge tractors.
<b>ORDER #:</b> 1030	<b>\$21.40</b>		376.2mm	Pattern	9.5mm	63.5mm	63.5mm	3.8mm	
		942-0645	14-13/16"	"H"	21/64"	2-1/2"	3"	.125"	Takes (1) 15-1038 & (2) 15-1037 for 46" cut. Fits deep deck riding mowers, 1997 & after. Mulching blade
<b>ORDER #:</b> 1038	<b>\$15.67</b>		376.2mm	Pattern	8.2mm	63.5mm	76.2mm	3.2mm	
		942-0486 742-0486	14-3/4"	13/32"	5/16"	2-1/2"	3"	.150"	Deep Deck, 800 series Takes (2) 15-6003 and (1) 15-6019 for 46" cut
<b>ORDER #:</b> 6019	<b>\$18.03</b>		374.7mm	10.3mm	7.9mm	63.5mm	76.2mm	3.8mm	
		742-04016 759-04020	14-7/8"	3/4"			2-1/2"	.204"	3 in 1 blade. Center blade for 46" cut. Fits deck series 1500, 1529, LT1045 & 1046. Uses (1) 15-11476 & (2) 15-11478
<b>ORDER #:</b> 11476	<b>\$19.96</b>		377.8mm	19.1mm			63.5mm	5.2mm	
		759-8312 742-3002	15-1/8"	3/4"			2-1/2"	.204"	(3) for 44" cut Current models
<b>ORDER #:</b> 6081	<b>\$15.07</b>		384.2mm	19.1mm			63.5mm	5.2mm	
		942-0118 742-0118	15-5/16"	3/8"	5/16"	2-1/2"	2"	.150"	(2) blades for 30" cut
<b>ORDER #:</b> 1077	<b>\$13.76</b>		388.9mm	9.5mm	7.9mm	63.5mm	50.8mm	3.8mm	
		1008616	15.94"	3/4"			3"	.204"	Fits Z force Zero Turn Rider. High Lift Blade (3) blades for a 44" cut.
<b>ORDER #:</b> 11805	<b>\$16.99</b>		405mm	19.1mm			76.2mm	5.2mm	

# BLADES

## Mower Blades



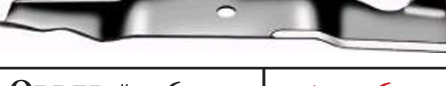
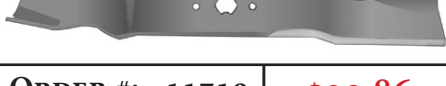







		Fits OEM	Length	Center Hole Diam.	Outside Hole Diam.	Center To Center	Width	Thick-ness	Application
		742-3025 759-3825 742-3019	16-1/2" 419.1mm	3/4" 19.1mm	5/16" 7.9mm	2-1/2" 63.5mm	2-1/2" 63.5mm	.204" 5.2mm	(3) blades for 48" cut garden tractor model 2000 & Pro mid size walk behind
<b>ORDER #:</b>	<b>6240</b>								<b>\$21.83</b>
		1004772	16-1/2" 419.1mm	3/4" 19.1mm			3" 76.2mm	.204" 5.2mm	Fits Zero Turn Rider (3) blades for 48" cut.
<b>ORDER #:</b>	<b>11564</b>								<b>\$29.55</b>
		742-04015 759-04019	16-1/4" 412.75mm	3/4" 19.1mm			2-1/2" 63.5mm	.204" 5.2mm	3 in 1 blade. Outer blade for 46" cut. Fits deck series 1500, 1529, LT1045 & 1046. Uses (1) 15-11476 & (2) 15-11478
<b>ORDER #:</b>	<b>11478</b>								<b>\$23.26</b>
		942-0542 742-0542	16-1/4" 412.8mm	"H" Pattern	5/16" 7.9mm	2-1/2" 63.5mm	3" 76.2mm	.125" 3.2mm	Takes (2) 15-1021 & (1) 15-1022 for 46" cut
<b>ORDER #:</b>	<b>1021</b>								<b>\$16.48</b>
		942-0611 742-0611	16-1/4" 412.8mm	"H" Pattern	3/8" 9.5mm	2-1/2" 63.5mm	2-1/2" 63.5mm	.150" 3.8mm	Takes (1) 15-1030 & (2) 15-1029 for 46" cut. Fits models 600 & 800 series 1997 & after, side discharge tractors. Mulching blade
<b>ORDER #:</b>	<b>1029</b>								<b>\$20.86</b>
		942-0644	16-1/4" 412.8mm	"H" Pattern	5/16" 7.9mm	2-1/2" 63.5mm	3" 76.2mm	.125" 3.2mm	Takes (1) 15-1038 & (2) 15-1037 for 46" cut. Fits deep deck riding mowers, 1997 & after. Mulching blade
<b>ORDER #:</b>	<b>1037</b>								<b>\$16.23</b>
		942-0487A 742-0487A	16-1/4" 412.8mm	13/32" 10.3mm	5/16" 7.9mm	2-1/2" 63.5mm	3" 76.2mm	.150" 3.8mm	Deep Deck, 800 series Takes (2) 15-6003 and (1) 15-6019 for 46" cut.
<b>ORDER #:</b>	<b>6003</b>								<b>\$15.51</b>
		759-3939	16" 406.4mm	3/4" 19.1mm	5/16" 7.94mm	2-1/2" 63.5mm	2-1/2" 63.5mm	.204" 5.2mm	(3) blades for a 44" cut. Used on mowers from 2001 to present.
<b>ORDER #:</b>	<b>10636</b>								<b>\$16.35</b>
		942-0171B 742-0171B 742-0171	17-1/4" 438.2mm	3/8" 9.5mm	5/16" 7.9mm	2-1/2" 63.5mm	2-1/2" 63.5mm	.204" 5.2mm	(3) blades for 36" cut
<b>ORDER #:</b>	<b>3356</b>								<b>\$22.84</b>
		1010168	17-29/32" 454.8mm	3/4" 19.1mm			2-1/2" 63.5mm	.204" 5.2mm	High Lift Blade (3) blades for a 50" cut. Fits Tank Commercial.
<b>ORDER #:</b>	<b>11250</b>								<b>\$15.93</b>
		759-3813 742-3003	17-3/16" 436.6mm	3/4" 19.1mm			2-1/2" 63.5mm	.204" 5.2mm	(3) blades for 50" cut
<b>ORDER #:</b>	<b>6082</b>								<b>\$18.05</b>

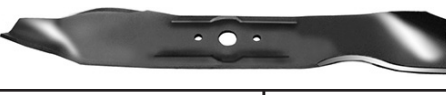





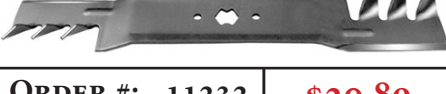
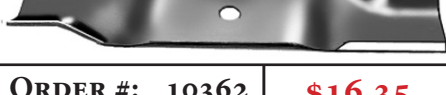

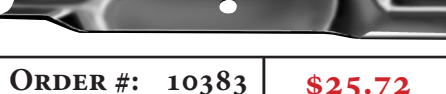

		Fits OEM	Length	Center Hole Diam.	Outside Hole Diam.	Center To Center	Width	Thick-ness	Application
		942-0623	17-5/16"	"H"	21/64"	2-1/2"	2-1/2"	.187"	(3) blades for 50" cut. Fits deep deck riding mowers, 1998 & after. Mulching blade
<b>ORDER #:</b> 1034	<b>\$18.28</b>		439.7mm	Pattern	8.2mm	63.5mm	63.5mm	4.8mm	
		759-04047 742-04068	17.9"	3/4"			2-1/2"	.150"	Fits 1000 series Hydro-static lawn tractors. Model LT1024. (3) blades for 50" cut.
<b>ORDER #:</b> 11479	<b>\$20.90</b>		454.6mm	19.1mm			63.5mm	3.8mm	
		742-04056 742-04053A	17.9"	Star			2-1/2"	.150"	Fits RZT series Tractors. Model RZT50 (3) blades for 50" cut.
<b>ORDER #:</b> 11480	<b>\$19.98</b>		454.6mm				63.5mm	3.8mm	
		742-04068	17.9"	3/4"			2-1/2"	.187"	Fits 1000 series Hydro-static lawn tractors. Model LT1024. Heavy Duty (3) blades for 50" cut.
<b>ORDER #:</b> 11506	<b>\$20.90</b>		454.6mm	19.1mm			63.5mm	4.8mm	
		742-04053A	17.9"	Star			2-1/2"	.187"	Fits RZT series Tractors. Heavy Duty Model RZT50 (3) blades for 50" cut.
<b>ORDER #:</b> 11507	<b>\$19.98</b>		454.6mm				63.5mm	4.8mm	
		742-04053A 942-04053A	17.9"	Star			2-1/2"	.187"	Commercial Mulcher Fits RTZ series tractors.
<b>ORDER #:</b> 12809	<b>\$19.98</b>		454.6mm				63.5mm	4.8mm	
		1005336	17"	3/4"			3"	.204"	(3) blades for 48" cut. High Lift Blade Fits Tanks Models
<b>ORDER #:</b> 10361	<b>\$15.44</b>		431.8mm	19.1mm			76.2mm	5.2mm	
		759-3841 759-3820 742-3013	18-1/2"	3/4"			3"	.204"	(3) blades for 54" cut garden tractor and Pro mid size walk behind
<b>ORDER #:</b> 6239	<b>\$20.63</b>		469.9mm	19.1mm			76.2mm	5.2mm	
		742-0677 942-0677	18-1/2"	"H"			3"	.204"	(3) blades for 54" cut. Fits 2002 and newer models 54" riders.
<b>ORDER #:</b> 11719	<b>\$20.86</b>		469.9mm	Pattern			76.2mm	5.2mm	
		942-0496 742-0496	18-3/16"	13/32"	5/16"	2-1/2"	3"	.150"	Deep Deck, 1989 & after (2) blades for 36" cut High lift
<b>ORDER #:</b> 6143	<b>\$19.69</b>		462mm	10.3mm	7.9mm	63.5mm	76.2mm	3.8mm	
		942-0738	18"	59/64" X 11/16"	5/16"	2-1/2"	2-1/4"	.134"	Mulching blade Fits MTD deck 1995 & newer. Fits 18" walkbehind.
<b>ORDER #:</b> 6448	<b>\$16.07</b>		457.2mm	Prox.*	7.9mm	63.5mm	57.2mm	3.4mm	

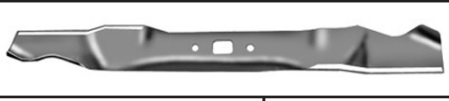
# BLADES

## Mower Blades









		Fits OEM	Length	Center Hole Diam.	Outside Hole Diam.	Center To Center	Width	Thick-ness	Application
		759-3817 742-3009	19-3/8" 492.1mm	3/4" 19.1mm	5/16" 7.9mm	2-1/2" 63.5mm	3" 76.2mm	.204" 5.2mm	(2) blades for 38" cut front engine rider models 1015, 1020, 1030, 1715 & 1720
<b>ORDER #:</b>	<b>6238</b>								<b>\$18.86</b>
		759-3829 742-3032	19-3/8" 492.3mm	3/4" 19.1mm			2-3/4" 69.85mm	.204" 5.2mm	3 in 1 blade. Fits deck series 2315 & 2146. (2) blades for a 38" cut.
<b>ORDER #:</b>	<b>11477</b>								<b>\$21.95</b>
		759-3816 742-3008	19-5/16" 490.5mm	3/4" 19.1mm			3" 76.2mm	.204" 5.2mm	(2) blades for 38" cut High lift
<b>ORDER #:</b>	<b>6147</b>								<b>\$21.00</b>
		942-0610	19-5/16" 490.5mm	"H" Pattern	5/16" 7.9mm	2-1/2" 63.5mm	3" 76.2mm	.150" 3.8mm	(2) blades for 38" cut
<b>ORDER #:</b>	<b>1024</b>								<b>\$20.89</b>
		942-0610	19-5/16" 490.5mm	"H" Pattern	5/16" 7.9mm	2-1/2" 63.5mm	3" 76.2mm	.150" 3.8mm	(2) blades for 38" cut. Mulching Blade
<b>ORDER #:</b>	<b>1026</b>								<b>\$20.89</b>
		942-0473A 742-0473A	19-5/16" 490.5mm	13/32" 10.3mm	5/16" 7.9mm	2-1/2" 63.5mm	3" 76.2mm	.150" 3.8mm	For 38" Deep Deck. Takes (1) 15-6006 and (1) 15-3471 or (2) 15-6006
<b>ORDER #:</b>	<b>6006</b>								<b>\$20.32</b>
		942-0537 742-0537	19-5/16" 490.5mm	.406" 10.3mm	.450" 11.4mm	2-1/2" 63.5mm	3" 76.2mm	.150" 3.8mm	Mulching blade Takes (2) for 38" cut use with our 15-6128
<b>ORDER #:</b>	<b>6126</b>								<b>\$17.91</b>
		942-0610	19-5/16" 490.5mm	"H" Pattern	5/16" 7.9mm	2-1/2" 63.5mm	3" 76.2mm	.150" 3.8mm	Commercial Mulcher (2) blades for 38" cut.
<b>ORDER #:</b>	<b>11232</b>								<b>\$20.89</b>
		1005337	19" 482.6mm	3/4" 19.1mm			3" 76.2mm	.204" 5.2mm	(3) blades for 54" cut. High Lift Blade Fits tank models
<b>ORDER #:</b>	<b>10362</b>								<b>\$16.35</b>
		742-0739 942-0739	19" 482.6mm	59/64" X 11/16"			2-1/4" 57.2mm	.125" 3.18mm	Fits 19" Walk behinds mowers. Mulching Blade
<b>ORDER #:</b>	<b>12893</b>								<b>\$14.98</b>
		1004719	20-1/2" 520.7mm	3/4" 19.1mm			3" 76.2mm	.204" 5.2mm	(3) blades for a 60" cut. Fits Cub Cadet & MTD Pro "ZERO TURN's" with stamped steel decks.
<b>ORDER #:</b>	<b>10383</b>								<b>\$25.72</b>

		Fits OEM	Length	Center Hole Diam.	Outside Hole Diam.	Center To Center	Width	Thick-ness	Application
		942-0620 742-0620 742-0520	20" 508mm	13/16" 20.6mm	3/8" 9.5mm	2-1/2" 63.8mm	2" 50.8mm	.150" 3.8mm	Fits 030/040 mower
<b>ORDER #:</b>	<b>6005</b>								<b>\$17.22</b>
		942-0720 942-0500 742-0500	20" 508mm	13/16" 20.6mm	3/8" 9.5mm	2-1/2" 63.5mm	2-1/4" 57.2mm	.125" 3.2mm	Fits 090 series 20" mulcher
<b>ORDER #:</b>	<b>6140</b>								<b>\$18.87</b>
		942-0740	20" 508mm	59/64" X 11/16" Prox.*	5/16" 7.9mm	2-1/2" 63.5mm	2-1/4" 57.2mm	.125" 3.2mm	Mulching blade Fits MTD deck 1997 & newer. Fits 20" walkbehind.
<b>ORDER #:</b>	<b>6438</b>								<b>\$13.99</b>
		942-0640	20" 508mm	59/64" X 11/16" Prox.*	5/16" 7.9mm	2-1/2" 63.5mm	2-1/4" 57.2mm	.125" 3.2mm	High lift blade Fits MTD deck 1997 & newer. Fits 20" walkbehind.
<b>ORDER #:</b>	<b>6439</b>								<b>\$14.32</b>
		759-3830 742-3033 742-04101	21-1/4" 539.75mm	3/4" 19.1mm			2-3/4" 69.85mm	.204" 5.2mm	3 in 1 blade. Fits deck series 1500 & 1517 (2) blades for a 42" cut.
<b>ORDER #:</b>	<b>11475</b>								<b>\$23.05</b>
		759-3824 742-3018	21-3/16" 538.2mm	3/4" 19.1mm	5/16" 7.9mm	2-1/2" 63.5mm	3" 76.2mm	.204" 5.2mm	(2) blades for 42" cut garden tractor models 2000 & 1440
<b>ORDER #:</b>	<b>6237</b>								<b>\$16.54</b>
		742-04126 942-0616 742-0616	21-3/16" 538.2mm	"H" Pattern	5/16" 7.9mm	2-1/2" 63.5mm	3" 76.2mm	.150" 3.8mm	Commercial Mulcher
<b>ORDER #:</b>	<b>11233</b>								<b>\$21.95</b>
		742-04126 942-0616 742-0616	21-3/16" 538.2mm	"H" Pattern	5/16" 7.9mm	2-1/2" 63.5mm	3" 76.2mm	.150" 3.8mm	(2) blades for 42" cut.
<b>ORDER #:</b>	<b>1031</b>								<b>\$17.98</b>
		742-0416 942-0616 742-0616	21-3/16" 538.2mm	"H" Pattern	5/16" 7.9mm	2-1/2" 63.5mm	3" 76.2mm	.150" 3.8mm	(2) blades for 42" cut. Mulching Blade
<b>ORDER #:</b>	<b>1032</b>								<b>\$21.95</b>
		942-0499A 742-0499A 742-0499	21-3/16" 538.2mm	13/32" 10.3mm	5/16" 7.9mm	2-1/2" 63.5mm	3" 76.2mm	.150" 3.8mm	Deep Deck 42" cut mower. Takes (2) blades, side discharge 1990 & after
<b>ORDER #:</b>	<b>6028</b>								<b>\$20.93</b>
		942-0538 742-0538	21-3/16" 538.2mm	13/32" 10.3mm	7/16" 11.1mm	2-1/2" 63.5mm	3" 76.2mm	.150" 3.8mm	Takes (2) for 42" cut use with our 15-6128
<b>ORDER #:</b>	<b>6127</b>								<b>\$19.12</b>

# BLADES

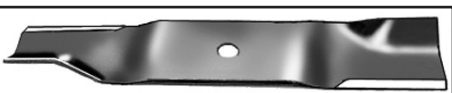

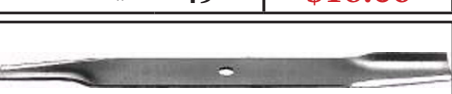
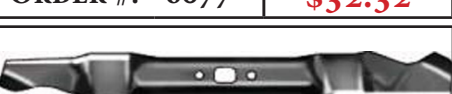







## Mower Blades



		Fits OEM	Length	Center Hole Diam.	Outside Hole Diam.	Center To Center	Width	Thick-ness	Application
			21-3/16" 538.2mm	13/32" 10.3mm	5/16" 7.9mm	2-1/2" 63.5mm	3" 76.2mm	.150" 3.8mm	Commercial Mulcher
<b>ORDER #:</b> 6295	<b>\$20.93</b>								
		942-0741 742-0741	21" 532.2mm	59/64" X 11/16" Prox.*	5/16" 7.9mm	2-1/2" 63.5mm	2-1/4" 57.2mm	.125" 3.2mm	Mulching blade Fits MTD deck 1995 & newer.
<b>ORDER #:</b> 6423	<b>\$15.44</b>								
		1005338	21" 533.4mm	3/4" 19.1mm			3" 76.2mm	.204" 5.2mm	(3) blades for 60" cut. High Lift Blade Fits Tanks models
<b>ORDER #:</b> 10363	<b>\$17.26</b>								
		942-0621A 742-0621 742-0306A	21" 533.4mm	13/16" 20.6mm	3/8" 9.5mm	2-1/2" 63.5mm	2-1/2" 63.5mm	.150" 3.8mm	21" Rear Bagger Fits models 816R, 818R, 462R thru 479R
<b>ORDER #:</b> 6042	<b>\$18.01</b>								
		942-0641	21" 533.4mm	59/64" X 11/16" Prox.*	5/16" 7.9mm	2-1/2" 63.5mm	2-1/4" 57.2mm	.134" 3.4mm	High lift blade. Fits MTD deck 1997 & newer. Fits 21" walkbehind.
<b>ORDER #:</b> 6450	<b>\$18.06</b>								
		759-3850 759-3843 477-597-R3 490-473-R1	22-3/16" 563.6mm	3/4" 19.1mm			2-1/2" 63.5mm	.204" 5.2mm	1968 to 1973 models Takes (1) 15-6077 & (2) 15-6075 for 42" cut.
<b>ORDER #:</b> 6077	<b>\$32.32</b>								
		942-0742 742-0742	22" 558.88mm	59/64" X 11/16" Prox.*	5/16" 7.9mm	2-1/2" 63.5mm	2-1/4" 57.2mm	.125" 3.2mm	Mulching blade Fits MTD deck 1995 & newer. Fits 22" walkbehind.
<b>ORDER #:</b> 6424	<b>\$15.98</b>								
		942-0642 742-0642	22" 558.88mm	59/64" X 11/16" Prox.*	5/16" 7.9mm	2-1/2" 63.5mm	2-1/4" 57.2mm	.125" 3.2mm	Fits MTD deck 1995 & newer. Fits 22" walkbehind.
<b>ORDER #:</b> 6425	<b>\$15.91</b>								
		942-04244 942-04290	23-1/2" 596.9mm	"H" Pattern			3" 76.2mm	.150" 3.81mm	Fits Cub Cadet series 100 LTX lawn tractors with 46" decks, 2009 and after. Also fits LTX1046.
<b>ORDER #:</b> 12956	<b>\$18.98</b>								



# MURRAY

		56631E701	15-11/16" 398.5mm	.850" 21.4mm			2-1/4" 57.2mm	.134" 3.4mm	(3) blades for 46" cut Mulcher
<b>ORDER #:</b> 6408	<b>\$10.95</b>								







		Fits OEM	Length	Center Hole Diam.	Outside Hole Diam.	Center To Center	Width	Thick-ness	Application
		92117E701	15-3/4"	27/32"			2-1/4"	.134"	(3) blades for 46" deck High Lift
ORDER #:	6113		400.1mm	21.4mm	57.2mm	3.4mm	<b>\$10.95</b>		
		91742E701	19-1/2"	.850"			2-1/4"	.187"	(Heavy Duty) (2) blades for 38" cut
ORDER #:	6119		495.3mm	21.4mm	57.2mm	4.8mm	<b>\$10.95</b>		
		92002E701	20-3/8"	.850"			2-1/4"	.150"	Low lift (2) blades for 40" cut
ORDER #:	6112		517.5mm	21.4mm	57.2mm	3.8mm	<b>\$9.75</b>		
		91871E701	20-3/8"	27/32"			2-1/4"	.187"	(2) blades for 40" cut (Heavy Duty)
ORDER #:	6129		517.5mm	21.4mm	57.2mm	4.8mm	<b>\$12.95</b>		
		71161E701	20-7/8"	13/32"			2-3/4"	.150"	Mulching Blade
ORDER #:	6160		530.2mm	10.3mm	69.9mm	3.8mm	<b>\$16.23</b>		
		92418E701 95101E701	21-1/4"	.850"			2-1/4"	.150"	(2) blades for 42" cut High Lift
ORDER #:	6162		539.8mm	21.4mm	57.2mm	3.8mm	<b>\$10.50</b>		
		095100E701A	21-3/16"	.850"			2-1/4"	.134"	3-n-1 Blade Takes (2) blades for 42" cut.
ORDER #:	6476		538.1mm	21.8mm	57.2mm	3.4mm	<b>\$12.50</b>		
		1101120E701 71849E701 71499E701 71113E701	22"	13/32"			2-1/4"	.150"	Mulching Blade for walkbehind
ORDER #:	6174		558.8mm	10.3mm	57.2mm	3.8mm	<b>\$9.50</b>		
		56246E701 56212E701	30"	.850"			2-3/4"	.160"	High Lift
ORDER #:	6027		762mm	21.4mm	69.9mm	4.1mm	<b>\$18.95</b>		
		56217 56210	30"	.850"			2-3/4"	.150"	Fits 30" rear engine rider models 2466A & 24661A Mulching Blade
ORDER #:	6215		762mm	21.4mm	69.9mm	3.8mm	<b>\$15.50</b>		

Fits OEM	Length	Center Hole Diam.	Outside Hole Diam.	Center To Center	Width	Thick-ness	Application
----------	--------	-------------------	--------------------	------------------	-------	------------	-------------

# NOMA







	00782971 8684 56820	16-1/8" 409.6mm	3/8" 9.5mm			1-15/16" 49.2mm	.134" 3.4mm	(2) blades for 32" cut rear Engine rider
<b>ORDER #:</b> 6021	<b>\$8.86</b>							
	00782965 39311	18-5/32" 461.2mm	3/8" 9.5mm			2" 50.8mm	.150" 3.8mm	(2) blades for 36" cut
<b>ORDER #:</b> 1085	<b>\$9.41</b>							

# SCAG

	483035	16-1/2" 419.1mm	5/8" 15.8mm				.204" 5.2mm	(3) blades for 48" cut mid size mower.
<b>ORDER #:</b> 3403	<b>\$16.07</b>							
	50111	16-1/2" 419.1mm	5/8" 15.9mm			3" 76.2mm	.204" 5.2mm	(3) blades for 48" cut
<b>ORDER #:</b> 6009	<b>\$29.72</b>							
	363291 482306	18" 457.2mm	5/8" 15.8mm				.204" 5.2mm	(2) blades for 36" cut mid size mower.
<b>ORDER #:</b> 3404	<b>\$17.33</b>							
	C-39949	21" 533.4mm	5/8" 15.8mm				.204" 5.2mm	(3) blades for 61" cut High lift
<b>ORDER #:</b> 3434	<b>\$19.27</b>							
	481712	21" 533.4mm	5/8" 15.8mm			3" 76.2mm	.204" 5.2mm	(3) Blades for 61" cut. High Lift Blade.
<b>ORDER #:</b> 10930	<b>\$38.16</b>							
	038-7220-00 038-7230-00	24-1/2" 622.3mm	5/8" 15.9mm			2-1/2" 63.5mm	.204" 5.2mm	(3) blades for 72" cut
<b>ORDER #:</b> 6026	<b>\$35.01</b>							





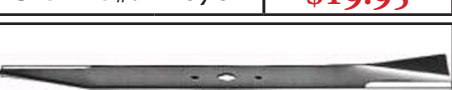
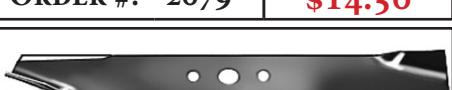
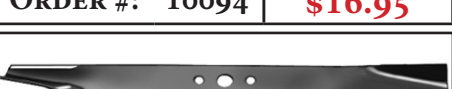



Fits OEM	Length	Center Hole Diam.	Outside Hole Diam.	Center To Center	Width	Thickness	Application
----------	--------	-------------------	--------------------	------------------	-------	-----------	-------------

# SIMPLICITY

	1656144	14-1/2" 368.3mm	3/4" 19.1mm	13/32" 10.3mm	3-1/16" 77.8mm	2" 50.8mm	.150" 3.8mm	(3) blades for 42" cut Left hand cut
<b>ORDER #:</b> 2083								<b>\$14.95</b>
	1656147	15-5/16" 388.9mm	3/4" 19.1mm	13/32" 10.3mm	2-9/16" 65.1mm	2" 50.8mm	.150" 3.8mm	(3) blades for 42" cut Right hand cut
<b>ORDER #:</b> 2081								<b>\$10.85</b>
	1704856	16-1/8" 409.6mm	3/4" 19.05mm			2" 50.8mm	.203" 5.15mm	Fits right side for 38" cut. LTH series. Also fits Allis-Chalmers. (3) for 44" cut
<b>ORDER #:</b> 10095								<b>\$13.95</b>
	1656143	16-11/16" 423.9mm	3/4" 19.1mm	13/32" 10.3mm	3-1/16" 77.8mm	2" 50.8mm	.150" 3.8mm	(3) blades for 48" cut Left hand cut
<b>ORDER #:</b> 2082								<b>\$16.40</b>
	1727774 1704100	16-9/64" 409.97mm	3/4" 19.05mm		2-9/16" 65.1mm	2" 50.8mm	.203" 5.15mm	Fits small frame garden tractor 1989 & later. Also fits Allis-Chalmers. (3) for 44" cut.
<b>ORDER #:</b> 10093								<b>\$15.95</b>
	1671565 1685172	18-1/2" 469.9mm	3/4" 19.1mm	13/32" 10.3mm	2-9/16" 65.1mm	2-1/2" 63.5mm	.187" 4.8mm	Takes (1) 15-2078 & (1) 15-2079 for 36" cut.
<b>ORDER #:</b> 2078								<b>\$19.95</b>
	1657589	18-1/2" 469.9mm	3/4" 19.1mm	13/32" 10.3mm	2-9/16" 65.1mm	2" 50.8mm	.187" 4.8mm	Takes (1) 15-2078 & (1) 15-2079 for 36" cut
<b>ORDER #:</b> 2079								<b>\$14.50</b>
	1726357 1726453A 1708229 1726453	18-9/64" 460.77mm	3/4" 19.05mm		2-9/16" 65.1mm	2" 50.8mm	.203" 5.15mm	Fits large frame tractors and Allis-Chalmers. Fits models 14-16 GT & 1700 series. (3) for 50" cut
<b>ORDER #:</b> 10094								<b>\$16.95</b>
	1704101	22-1/4" 565.2mm	3/4" 19.05mm			2" 50.8mm	.203" 5.15mm	Fits 38" cut. LTH and 1600 series. Also fits Allis-Chalmers. Left side blade.
<b>ORDER #:</b> 10096								<b>\$18.50</b>

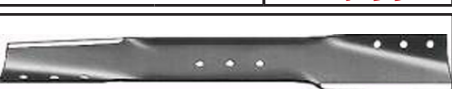
Fits OEM	Length	Center Hole Diam.	Outside Hole Diam.	Center To Center	Width	Thick-ness	Application
----------	--------	-------------------	--------------------	------------------	-------	------------	-------------

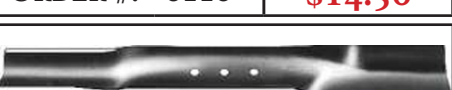
# SNAPPER

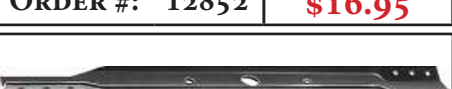
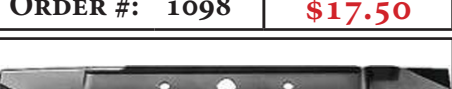
	7019733	16-1/2" 419.1mm	3/8" 9.5mm			2-3/4" 69.9mm	.160" 4.1mm	(3) blades on LT48 Steel Deck
<b>ORDER #:</b> 2169								<b>\$13.20</b>
	75771 7029247	16-1/2" 419.1mm	5/8" 16mm			2-1/2" 63.5mm	.204" 5.2mm	Fits Yardcruiser model HZS 1848 2BVE homeowner model.
<b>ORDER #:</b> 6472								<b>\$15.50</b>
	7079388	17" 431.8mm	1/2" 12.7mm			2-1/2" 63.5mm	.204" 5.2mm	48" deck For Snapper "ZERO TURN" machine Hi Lift Blade
<b>ORDER #:</b> 6035								<b>\$15.95</b>
	7024466 7042998	19-41/64" 498.9mm	1" 25.4mm			2-1/4" 57.2mm	.204" 5.2mm	(2) blades for 38" cut front engine rider models LT1438H & Black Hawk model BH120G38A
<b>ORDER #:</b> 6197								<b>\$17.95</b>
	7019795	20-11/16" 525.5mm	3/8" 9.5mm	3/8" 9.5mm	2-3/4" 69.9mm	2-3/4" 69.9mm	.160" 4.1mm	Uses 15-910 Air lifts Steel Deck
<b>ORDER #:</b> 2007								<b>\$15.50</b>
	7017168 7041939	20-11/16" 525.5mm	3/8" 9.5mm	3/8" 9.5mm		2-3/4" 69.9mm	.160" 4.1mm	Mulcher blade for 21" Steel Deck
<b>ORDER #:</b> 6110								<b>\$14.50</b>
	7017002 7019702 7019645 7026691	20-3/4" 527.1mm	3/8" 9.5mm	3/8" 9.5mm	2-3/4" 69.9mm	2-3/4" 69.9mm	.160" 4.1mm	Used on 21" & 41" Steel Deck
<b>ORDER #:</b> 2006								<b>\$14.50</b>
	1731898	21-3/16" 538.1mm	.975" 24.7mm			2-1/4" 57.2mm	.170" 4.3mm	Fits LT-200 series & Zero Turn 150Z series 42" cut.
<b>ORDER #:</b> 12852								<b>\$16.95</b>
	7019515	28" 711.2mm	1-1/16" 27mm	0.546875 13.9mm	7-1/2" 190.5mm	2-3/4" 69.9mm	.187" 4.8mm	New Style Uses the 3 bolt hole High air lifts 15-1136
<b>ORDER #:</b> 1098								<b>\$17.50</b>
	7016980	28" 711.2mm	1-1/16" 27mm	35/64" 13.9mm	7-1/2" 190.5mm	2-3/4" 69.9mm	.160" 4.1mm	Mulching blade For 28" rear engine riders
<b>ORDER #:</b> 6108								<b>\$21.50</b>

		Fits OEM	Length	Center Hole Diam.	Outside Hole Diam.	Center To Center	Width	Thick-ness	Application
		7019523	33"	1-1/16"	35/64"	7-1/2"	2-3/4"	.187"	New Style Uses the 3 bolt hole. High Air Lifts 15-1136
<b>ORDER #:</b> 1060			838.2mm	27mm	13.9mm	190.5mm	69.9mm	4.8mm	
		<b>\$22.70</b>							

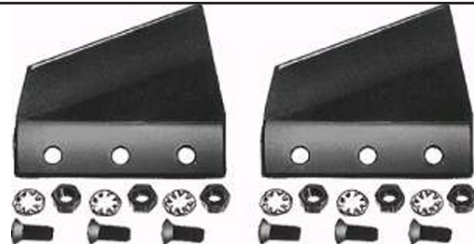





















**ORDER #: 1136**      **SUGG LIST: \$12.05**

Complete Kit. Replaces Snapper 7060480. Used on 1060, 1098 and 1103 blades. Includes (6) 5/16"-24x3/4" screws, (6) 5/16 lock washers, & (6) 5/16"-24 hex nuts.

# TORO

		117192	13-7/8"	3/4"			2"	.187"	For 42" cut side discharge (set of 3 # 3-11620)
<b>ORDER #:</b> 2000			352.4mm	19.1mm			50.8mm	4.8mm	
		<b>\$14.29</b>							
		10610	14-1/2"	3/4"			2"	.204"	For 42" cut, Rear discharge WH set 106635
<b>ORDER #:</b> 851			368.3mm	19.1mm			50.8mm	5.2mm	
		<b>\$10.99</b>							
		55-4940	15-1/2"	5/8"			2-1/2"	.187"	Fits Model 30144 44" Midsize Cutting Mower High Lift
<b>ORDER #:</b> 3393			393.7mm	15.9mm			63.5mm	4.8mm	
		<b>\$24.31</b>							
		54-0010	15-1/2"	5/8"			2-1/2"	.187"	(3) blades for 44" cut Deck 57358, Groundsmaster model 117 and 1144 rider tractor
<b>ORDER #:</b> 3441			393.7mm	15.9mm			63.5mm	4.8mm	
		<b>\$19.98</b>							
		106637	16"	3/4"			2"	.187"	For 48" cut side discharge Wheel Horse set (3-10607)
<b>ORDER #:</b> 2001			406.4mm	19.1mm			50.8mm	4.8mm	
		<b>\$12.63</b>							
		110-6837-03	17-1/2"	5/8"			2-1/4"	.170"	High Lift Blade. Fits model Timecutter Z (3) blades for a 50" cut.
<b>ORDER #:</b> 12273			444.5mm	15.9mm			57.2mm	4.3mm	
		<b>\$22.09</b>							

		Fits OEM	Length	Center Hole Diam.	Outside Hole Diam.	Center To Center	Width	Thick-ness	Application
		109918	18-3/4"	3/4"			2"	.204"	Takes (2) for 37" cut Wheel Horse Set 109079
<b>ORDER #:</b> 3468	<b>\$25.37</b>		476.3mm	19.1mm	50.8mm	5.2mm			
		27-0990	18"	1/2"			2-1/2"	.187"	(3) blades for 52" cut Groundmaster Std. Lift
<b>ORDER #:</b> 3361	<b>\$19.85</b>		457.2mm	12.7mm	63.5mm	4.8mm			
		55-4210	18"	5/8"			2"	.187"	Fits model 30136 and 30152. For 36" and 52" cut. Midsize mowers
<b>ORDER #:</b> 3394	<b>\$27.48</b>		457.2mm	15.9mm	50.8mm	4.8mm			
		56-2390	18"	1/2"			2-1/2"	.187"	(2) blades for 36" cut & (3) blades for 52" cut High Lift
<b>ORDER #:</b> 3405	<b>\$21.14</b>		457.2mm	12.7mm	63.5mm	4.8mm			
			18"	1/2"			2-1/2"	.187"	Commercial Mulcher
<b>ORDER #:</b> 6410	<b>\$21.14</b>		457.2mm	12.7mm	63.5mm	4.8mm			
		79-3061 14-7799	19-1/4"	5/8"			2-1/2"	.187"	(2) blades for 38" cut "ZERO TURN" models 616 & 620 mulching blade
<b>ORDER #:</b> 6184	<b>\$22.09</b>		489mm	15.9mm	63.5mm	4.8mm			
		57-4700	19-5/16"	5/8"			2-1/2"	.187"	38" cut Fits 612, 616 and 620 ZT unit. Also fits 200 series side discharge
<b>ORDER #:</b> 3395	<b>\$26.43</b>		490.5mm	15.9mm	63.5mm	4.8mm			
		112947	20-1/2"	5/8"			2-1/2"	.204"	Fits Wheel Horse
<b>ORDER #:</b> 9171	<b>\$23.78</b>		520.7mm	15.8mm	63.5mm	5.2mm			
		93-0241	20-1/4"	7/16"			2-1/2"	.134"	Fits 21" Toro recycler with 4.5 hp motor. Fits model 20444.
<b>ORDER #:</b> 6275	<b>\$22.09</b>		514.4mm	11.1mm	63.5mm	3.4mm			
		93-4106-03 108-3762-03	20-27/32"	7/16"	3/8"	2-7/16"	2-1/4"	.150"	Fits 21" Recycler Walkbehind mower.
<b>ORDER #:</b> 10928	<b>\$20.08</b>		531mm	11mm	9.5mm	61.9mm	57.2mm	3.8mm	
		612543-03 612543 683682 608094	20-7/8"	5/8"	17/32"	2-9/16"	3"	.134"	For 21" Tri cut (Std.)
<b>ORDER #:</b> 849	<b>\$19.95</b>		530.2mm	15.9mm	5.6mm	65.1mm	76.2mm	3.4mm	

		Fits OEM	Length	Center Hole Diam.	Outside Hole Diam.	Center To Center	Width	Thick-ness	Application
		44-6250	21-1/2"	1/2"			2-1/2"	.187"	(3) blades for 62" cut Fits Toro 62" cut Groundmaster
<b>ORDER #:</b> 6251	<b>\$20.74</b>		546.1mm	12.7mm			63.5mm	4.8mm	
		104-8697-03 108-9764-03	21-23/32"	7/16"			2-1/4"	.150"	Fits 22" Recycler Walkbehind mower.
<b>ORDER #:</b> 10929	<b>\$22.09</b>		551.7mm	11mm			57.2mm	3.8mm	
			21-23/32"	7/16"			2-1/4"	.150"	Commercial Mulcher Fits 22" Recycler
<b>ORDER #:</b> 12649	<b>\$17.50</b>		551.6mm	11.1mm		57.2mm	3.8mm		
			21-5/8"	5/8"			2-1/2"	.160"	Commercial Mulcher (2) blades for a 42" cut.
<b>ORDER #:</b> 13129	<b>\$21.14</b>		549.2mm	15.9mm		63.5mm	4.1mm		
		106-2247-03	21.675"	5/8"			2-1/4"	.160"	Fits model Time Cutter Z Standard Blade (2) blades for a 42" cut.
<b>ORDER #:</b> 11821	<b>\$22.09</b>		550.5mm	15.8mm			57.2mm	4.1mm	
		20-2720	21"	7/16"			2-5/8"	.125"	Guardian
<b>ORDER #:</b> 1006	<b>\$22.09</b>		533.4mm	11.1mm			66.7mm	3.2mm	
		26-0880 42-1000	21"	7/16"	3/8"	2-7/16"	2-5/8"	.125"	Toro rear bagger and Grassmaster
<b>ORDER #:</b> 1008	<b>\$23.26</b>		533.4mm	11.1mm	9.5mm	61.9mm	66.7mm	3.2mm	
		108-0954-03	21"	7/16"			2-1/4"	.150"	Commercial Mulcher Replaces Toro Atomic Bld
<b>ORDER #:</b> 13260	<b>\$20.99</b>		533.4mm	11.1mm			57.2mm	4mm	
		29-5530	25"	3/4"			2-1/2"	.240"	(3) for 72" cut Groundsmaster Left hand cut
<b>ORDER #:</b> 3362	<b>\$24.92</b>		635mm	19.1mm			63.5mm	6.1mm	



# WALKER

		5705-0	20"	5/8"	3/16"	3"	2-3/4"	.160"	Uses (3) blades for 54" side discharge Right hand
<b>ORDER #:</b> 3423	<b>\$15.59</b>		508mm	15.9mm	4.8mm	76.2mm	69.9mm	4.1mm	



# BLADES











## Mower Blades



		Fits OEM	Length	Center Hole Diam.	Outside Hole Diam.	Center To Center	Width	Thick-ness	Application
			22" 558.8mm	5/8" 15.9mm	3/16" 4.8mm	3" 76.2mm	2-3/4" 69.9mm	.187" 4.8mm	Commercial Mulcher
<b>ORDER #:</b> 6414	<b>\$18.15</b>								
		7705-2	25-1/16" 636.6mm	5/8" 15.9mm	7/32" 5.6mm	3" 76.2mm	2-3/4" 69.9mm	.160" 4.1mm	(1) 15-6169 & (1) 15-6170 for 48" cut Left hand cut
<b>ORDER #:</b> 6169	<b>\$21.04</b>								
		7705-1	25-1/16" 636.6mm	5/8" 15.9mm	7/32" 5.6mm	3" 76.2mm	2-3/4" 69.9mm	.160" 4.1mm	(1) 15-6169 & (1) 15-6170 for 48" cut Right hand cut
<b>ORDER #:</b> 6170	<b>\$21.04</b>								

# WOODS











		31359	20-1/4" 514.4mm	5/8" 15.9mm			2" 50.8mm	.204" 5.2mm	(3) blades for 60" cut. Fits models RM59, RM500, L59 & F35. High Lift Blade. Left hand cut.
<b>ORDER #:</b> 6432	<b>\$11.28</b>								
		23825	20-5/32" 512mm	5/8" 15.9mm			2" 50.8mm	.204" 5.2mm	(3) blades for 60" cut For models RM-59 & L-59 Left hand cut (ccw)
<b>ORDER #:</b> 3421	<b>\$13.20</b>								

		Length	Center Hole Diam.	Width	Steel Thickness	Description / Application
		6-3/16" 157.2mm	1/2" 12.7mm	1-1/2" 38.1mm	.095" 2.4mm	Replaces Black & Decker 82-010. Fits electric edgers
<b>ORDER #:</b> 6764	<b>\$4.50</b>					
		7-17/32" 191.3mm	7/16" 11.1mm	1-1/2" 38.1mm	.095" 2.4mm	Unsharpened. Fits Black & Decker 82-024
<b>ORDER #:</b> 6172	<b>\$4.50</b>					
		7-11/16" 195.3mm	1" 25.4mm	2" 50.8mm	.125" 3.2mm	Fits Green Machine & Echo Trimmer/ Edger & Stihl FC 72 trimmer. Stihl 4133-713-4101, Echo 720-237-001, and Ryobi 613223. (NHT) Pro Series Rust Resistant, oiled finish.
<b>ORDER #:</b> 6477	<b>\$1.95</b>					
		8-1/4" 209.6mm	3/4" 19mm	2-3/4" 69.9mm	.095" 2.4mm	Replacement for Poulan- Weedeater.
<b>ORDER #:</b> 9886	<b>\$7.75</b>					
		8-1/2" 215.9mm	9/16" D" 14.3mm	1-1/2" 38.1mm	.120" 3.17mm	Replaces Weedeater 530095086. Fits gas powered edgers.
<b>ORDER #:</b> 6788	<b>\$4.88</b>					
		8-9/16" 217.5mm	1/2" 12.7mm	2" 50.8mm	.095" 2.4mm	Unsharpened
<b>ORDER #:</b> 2672	<b>\$3.50</b>					
		8-3/4" 222.3mm	1/2" 12.7mm	2-1/4" 57.2mm	.150" 3.8mm	Fits Lawn-Boy and McLane 2059-HD
<b>ORDER #:</b> 1145	<b>\$3.95</b>					
		8-3/4" 222.3mm	1" 25.4mm	2" 50.8mm	.095" 2.4mm	Fits Homelite model E200 & PSE300 stick edger
<b>ORDER #:</b> 6261	<b>\$7.97</b>					
		9" 228.6mm	3/8" 9.5mm	2" 38.1mm	.117" 3mm	Tapered, Sharpened 4 sides
<b>ORDER #:</b> 1137	<b>\$3.75</b>					
		9" 228.6mm	1/2" 12.7mm	2" 50.8mm	.117" 3mm	Tapered, Sharpened 4 sides Also available in 50 per box.
<b>ORDER #:</b> 1138	<b>\$3.95</b>					
		9" 228.6mm	5/8" 15.9mm	2" 50.8mm	.117" 3mm	Tapered, Sharpened 4 sides Also available in 50 per box.
<b>ORDER #:</b> 1139	<b>\$3.95</b>					

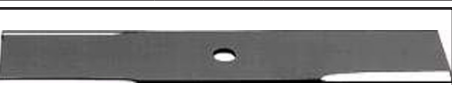
# BLADES

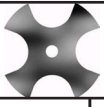
## Edger Blades











		Length	Center Hole Diam.	Width	Steel Thickness	Description / Application
		9"	1/2"	2"	.095"	Unsharpened Also available in 50 per box.
ORDER #:	2671	228.6mm	12.7mm	50.8mm	2.4mm	
	<b>\$3.50</b>					
		9-1/4"	5/8"	2-1/2"	.095"	Trail mate/Cooper blade. Replaces MTD 781-0080
ORDER #:	2148	235mm	15.9mm	63.5mm	2.4mm	
	<b>\$3.25</b>					
		10"	1/2"	2"	.125"	Tapered, Sharpened 4 sides Also available in 50 per box.
ORDER #:	1143	254mm	12.7mm	50.8mm	3.2mm	
	<b>\$3.75</b>					
		10"	5/8"	2"	.125"	Tapered, Sharpened 4 sides Also available in 50 per box.
ORDER #:	1144	254mm	15.9mm	50.8mm	3.2mm	
	<b>\$3.75</b>					
		10"	1/2"	2"	.117"	Fits Little Wonder Sharpened 4 sides Also available in 50 per box.
ORDER #:	1148	254mm	12.7mm	50.8mm	2.8mm	
	<b>\$3.95</b>					
		10"	1/2"	2"	.125"	Unsharpened Also available in 50 per box.
ORDER #:	2670	254mm	12.7mm	50.8mm	3.2mm	
	<b>\$3.50</b>					
		12-1/8"	1/2"	2"	.125"	Unsharpened
ORDER #:	2669	308mm	12.7mm	50.8mm	3.2mm	
	<b>\$4.50</b>					
		8"	1"		.095"	Fits Green Machine and Edger Tool. Also fits Echo model PE2400 and Shindaiwa model LE-20
ORDER #:	6276	203.2mm	25.4mm		2.4mm	
	<b>\$6.75</b>					
		9"	5/8"			Star Edger Blade. Replaces Trailmate 11250
ORDER #:	2661	228.60mm	15.88mm			
	<b>\$9.50</b>					
		9"	1/2"			Star Edger Blade
ORDER #:	1147	228.6mm	12.70mm			
	<b>\$12.45</b>					
		9"	1/2"			Star Edger Blade
ORDER #:	2658	228.6mm	12.70mm			
	<b>\$9.50</b>					

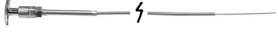





# Universal Cables





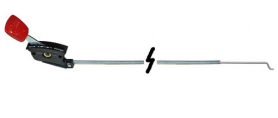

## UNIVERSAL CABLES..... 33





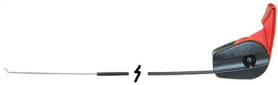
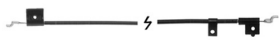

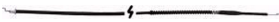
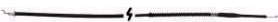
- » *Throttle, Choke, & Stop Cables*.....34
- » *Cable Accessories*.....40



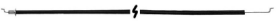

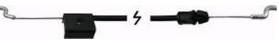
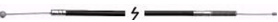

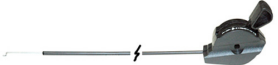





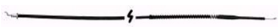
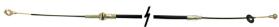
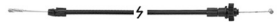
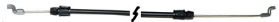

 <p>Conduit 120" Inner Wire 126" Wire Travel 3"</p>	 <p>Conduit 60" Inner Wire 64-1/2" Wire Travel 1"</p>
<p><b>ORDER #:</b> 223      <b>SUGG LIST:</b> \$32.50</p>	<p><b>ORDER #:</b> 228      <b>SUGG LIST:</b> \$37.18</p>
<p>Turn-To-Lock. Universal control ideal for throttle control. Positive action control.</p>	<p>Replaces Murray 21223PA. Positive action control. Has plastic covered conduit. Conduit size 3/16", Innerwire .058". With knob.</p>
 <p>Conduit 60" Inner Wire 64-1/2" Wire Travel 1"</p>	 <p>Conduit 11-25/32" Inner Wire 14-3/32" Wire Travel 1-9/16"</p>
<p><b>ORDER #:</b> 229      <b>SUGG LIST:</b> \$14.50</p>	<p><b>ORDER #:</b> 231      <b>SUGG LIST:</b> \$16.50</p>
<p>Replaces Murray 21222PA. Positive action control. Conduit size 3/16", Innerwire .058". With knob.</p>	<p>Replaces Snapper 7018889. Negative action control. Used on Briggs &amp; Stratton equipped riding mowers. Side mount.</p>
 <p>Conduit 59-3/16" Inner Wire 62-5/8" Wire Travel 1-5/8"</p>	 <p>Conduit 53" Inner Wire 56-1/2" Wire Travel 1-1/4"</p>
<p><b>ORDER #:</b> 234      <b>SUGG LIST:</b> \$11.95</p>	<p><b>ORDER #:</b> 235      <b>SUGG LIST:</b> \$6.92</p>
<p>Replaces Snapper 7011991. Positive action control. Used on Briggs &amp; Stratton equipped Snapper riding mowers. Fits 8 hp Briggs &amp; Stratton.</p>	<p>Deluxe lever throttle with all the plus features screw in loom, steel constructed, plated and full 1-1/4" protected span. Uses our 04-11548 swivel.</p>
 <p>Conduit 53" Inner Wire 55-7/8" Wire Travel 1-3/16"</p>	 <p>Conduit 60" Inner Wire 63" Wire Travel 2-3/4"</p>
<p><b>ORDER #:</b> 236      <b>SUGG LIST:</b> \$8.50</p>	<p><b>ORDER #:</b> 237      <b>SUGG LIST:</b> \$8.25</p>
<p>A throttle designed for use with the choke-o-matic type carburetor. Negative Action Control. Attractive black label and handle.</p>	<p>Push-Pull control for engine speed or choke control. Fits many types of equipment, including Bobcat. Positive action control.</p>

 <p style="text-align: center;">Conduit 48-3/4" Inner Wire 52-3/16" Wire Travel 1-1/8"</p>	 <p style="text-align: center;">Conduit 48" Inner Wire 51" Wire Travel 1-3/16"</p>
<p><b>ORDER #:</b> 239      <b>SUGG LIST:</b> \$12.95</p>	<p><b>ORDER #:</b> 243      <b>SUGG LIST:</b> \$9.50</p>
<p>Positive action black control with red knob replaces Snapper 7018186. Rear detent for stop position. Used on automatic choke carburetor.</p>	<p>Positive action lever control. Replaces many models of Ariens, Atlas and AMF.</p>
 <p style="text-align: center;">Conduit 48" Inner Wire 50-5/16" Wire Travel 1-7/32"</p>	 <p style="text-align: center;">Conduit 40" Inner Wire 42" Wire Travel 1-5/8"</p>
<p><b>ORDER #:</b> 244      <b>SUGG LIST:</b> \$8.80</p>	<p><b>ORDER #:</b> 866      <b>SUGG LIST:</b> \$10.44</p>
<p>Positive action lever control. Plastic knob with steel lever. Used on many models of Roper, Snapper, Yardman, Jacobsen and Southland mowers.</p>	<p>Replaces McLane 1013B. Negative action control. Used on Briggs &amp; Stratton equipped edgers. Single lever control.</p>
 <p style="text-align: center;">Conduit 48" Inner Wire 497/8" Wire Travel 1-11/32"</p>	 <p style="text-align: center;">Conduit 13-1/2" Inner Wire 15-5/8" Wire Travel 1-1/2"</p>
<p><b>ORDER #:</b> 946      <b>SUGG LIST:</b> \$6.55</p>	<p><b>ORDER #:</b> 5805      <b>SUGG LIST:</b> \$16.50</p>
<p>48" black plastic conduit control. Positive action. Used on Murray, Air Cap, MTD &amp; Roper. Segmented detent. Smooth operating.</p>	<p>Replaces Snapper 7018889. Used on 8, 10, 11 and 12 hp B&amp;S equipped riders. (Heavy Duty)</p>
 <p style="text-align: center;">Conduit 43-1/2" Inner Wire 47" Wire Travel 1-5/8"</p>	 <p style="text-align: center;">Conduit 66" Inner Wire 71" Wire Travel 1-5/8"</p>
<p><b>ORDER #:</b> 6657      <b>SUGG LIST:</b> \$6.55</p>	<p><b>ORDER #:</b> 6658      <b>SUGG LIST:</b> \$7.15</p>
<p>Negative action control. This universal control can be mounted between or on side of handle bar.</p>	<p>Negative action control. This universal control can be mounted between or on side of handle bar.</p>

 <p>Conduit 60-13/32" Inner Wire 62-9/32" Wire Travel 1-3/4"</p>	 <p>Conduit 50" Inner Wire 55" Wire Travel 1-1/2"</p>
<p><b>ORDER #:</b> 7961      <b>SUGG LIST:</b> \$8.75</p>	<p><b>ORDER #:</b> 7974      <b>SUGG LIST:</b> \$8.50</p>
<p>Throttle control fits Murray 42096, Air Cap, MTD and Roper. Positive action control.</p>	<p>Throttle control replaces Murray 71180, 71157 on walk behind mowers. Plastic conduit converts from positive to negative action.</p>
 <p>Conduit 71" Inner Wire 76" Wire Travel 1-1/2"</p>	 <p>Conduit 45-1/2" Inner Wire 54-1/2" Wire Travel 7-3/8"</p>
<p><b>ORDER #:</b> 7975      <b>SUGG LIST:</b> \$8.75</p>	<p><b>ORDER #:</b> 8416      <b>SUGG LIST:</b> \$10.50</p>
<p>Throttle control fits Murray walk behind mowers. Plastic conduit converts from positive to negative action.</p>	<p>Engine stop cable replaces Murray 43749 &amp; 42363. 45-1/2" conduit length, 54-1/2" wire length. Plastic covered conduit with brackets.</p>
 <p>Conduit 68" Inner Wire 69-1/4" Wire Travel 1-7/16"</p>	 <p>Inner Wire 60" Spring Length 8-1/2" Wire Travel 2-1/2"</p>
<p><b>ORDER #:</b> 8530      <b>SUGG LIST:</b> \$18.50</p>	<p><b>ORDER #:</b> 9130      <b>SUGG LIST:</b> \$7.66</p>
<p>Throttle control assembly replaces Murray 420005. Includes throttle control, nut, screw, 4" cable ties, mounting adapter &amp; instructions. (carded)</p>	<p>Throttle wire replaces MTD 746-0632, 746-0474. "Z" bend on each end.</p>
 <p>Inner Wire 60" Spring Length 8-1/2" Wire Travel 2-1/2"</p>	 <p>Conduit 45" Inner Wire 47-3/8" Wire Travel 2-5/8"</p>
<p><b>ORDER #:</b> 9131      <b>SUGG LIST:</b> \$10.01</p>	<p><b>ORDER #:</b> 9132      <b>SUGG LIST:</b> \$15.29</p>
<p>Throttle wire replaces MTD 746-0672. Fits walkbehind and self-propelled walkbehinds that require a 58" yellow cable.</p>	<p>Throttle wire replaces MTD 746-0845. Fits 1992 &amp; later push &amp; self-propelled mowers with Tecumseh engines. "Z" bends on each end.</p>

 <p>Conduit 51-1/4" Inner Wire 53-5/8" Wire Travel 2-1/2"</p>	 <p>Conduit 55-3/8" Inner Wire 57-3/4" Wire Travel 2-1/2"</p>
<p><b>ORDER #:</b> 9133      <b>SUGG LIST:</b> \$7.66</p>	<p><b>ORDER #:</b> 9134      <b>SUGG LIST:</b> \$7.66</p>
<p>Throttle wire replaces MTD 746-0842. Fits 1992 &amp; later push mowers with B&amp;S engines. "Z" bends at both ends.</p>	<p>Throttle wire replaces MTD 746-0843. Fits 1992 &amp; later push &amp; self-propelled mowers with B&amp;S engines. "Z" bends at both ends</p>
 <p>Conduit 41" Inner Wire 43" Wire Travel 2"</p>	 <p>Conduit 52" Inner Wire 59-3/16"</p>
<p><b>ORDER #:</b> 9135      <b>SUGG LIST:</b> \$24.77</p>	<p><b>ORDER #:</b> 9566      <b>SUGG LIST:</b> \$11.82</p>
<p>Throttle control replaces Wheel Horse 102119. Locking push-pull cable. "T" marked for throttle. 9/16" mount hole.</p>	<p>Engine stop cable replaces AYP 130861. Fits 22" walkbehind push mowers. Model PP751. Also fits YardPro &amp; Husky mowers.</p>
 <p>Conduit 13-1/2" Inner Wire 15-1/2" Wire Travel 4-1/4"</p>	 <p>Conduit 63" Inner Wire 64-7/8" Wire Travel 1-7/8"</p>
<p><b>ORDER #:</b> 9567      <b>SUGG LIST:</b> \$7.60</p>	<p><b>ORDER #:</b> 9679      <b>SUGG LIST:</b> \$9.41</p>
<p>Throttle cable replaces Echo 178001-00761. Fits blower models PB400 &amp; PB400E.</p>	<p>Throttle control replaces AYP 851462.</p>
 <p>Conduit 47" Inner Wire 49-1/4" Wire Travel 2-1/4"</p>	 <p>Conduit 42" Inner Wire 48" Wire Travel 2-1/4"</p>
<p><b>ORDER #:</b> 9680      <b>SUGG LIST:</b> \$10.82</p>	<p><b>ORDER #:</b> 9681      <b>SUGG LIST:</b> \$14.99</p>
<p>Throttle control replaces AYP 700417. Fits 20" &amp; 22" side and rear discharge mowers. Axial negative.</p>	<p>Choke control replaces MTD 746-0613A. Total length 49-1/2".</p>

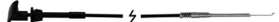
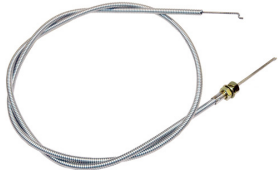
 <p>Conduit 34" Inner Wire 39-1/4" Wire Travel 1-1/2"</p>	 <p>Conduit 18-3/4" Inner Wire 24-1/4" Wire Travel 1-1/2"</p>
<p><b>ORDER #:</b> 9682      <b>SUGG LIST:</b> \$13.41</p>	<p><b>ORDER #:</b> 9683      <b>SUGG LIST:</b> \$14.41</p>
<p>Choke control replaces MTD 746-0614A. Fits mid size rear engine riders. Total length 41".</p>	<p>Choke control replaces MTD 746-0616A. Total length 26".</p>
 <p>Conduit 36" Inner Wire 38" Wire Travel 3"</p>	 <p>Conduit 45" Inner Wire 54-3/4" Wire Travel 9-1/4"</p>
<p><b>ORDER #:</b> 9855      <b>SUGG LIST:</b> \$5.98</p>	<p><b>ORDER #:</b> 10123      <b>SUGG LIST:</b> \$23.18</p>
<p>Throttle cable replaces MTD 746-0634A. Fits MTD models 600-609, 660-669, 670-679, 690-699, series tractors with twin cylinder engines.</p>	<p>Blade stop cable replaces Honda 54530-VE0-003. Fits models HR-B215XA, HRB215K15XR, RB215K2HXA.</p>
 <p>Conduit 53" Inner Wire 57"</p>	 <p>Conduit 40" Inner Wire 46-3/8"</p>
<p><b>ORDER #:</b> 10684      <b>SUGG LIST:</b> \$16.98</p>	<p><b>ORDER #:</b> 10688      <b>SUGG LIST:</b> \$11.64</p>
<p>Drive cable replaces MTD 746-0713. Fits 21" walkbehind mowers.</p>	<p>Engine stop cable replaces MTD 746-0550. Used on push mowers models: 040, 050, 060, 070, 080 &amp; 090. Z bend on each end.</p>
 <p>Conduit 44" Inner Wire 50"</p>	 <p>Conduit 42-1/2" Inner Wire 48-3/4"</p>
<p><b>ORDER #:</b> 10690      <b>SUGG LIST:</b> \$6.59</p>	<p><b>ORDER #:</b> 10692      <b>SUGG LIST:</b> \$6.75</p>
<p>Engine stop cable replaces Murray 1101093. Fits 20" walkbehind mowers from 2000-2003. 3/16" Z bend on one end, 1/4" T on other end.</p>	<p>Engine stop cable replaces Murray 1101360. 3/16" Z bend on one end, 1/4" T on other end.</p>

 <p style="text-align: center;">Conduit 52" Inner Wire 59-1/4"</p>	 <p style="text-align: center;">Conduit 40" Inner Wire 48-1/2"</p>
<p><b>ORDER #:</b> 10693      <b>SUGG LIST:</b> \$6.95</p>	<p><b>ORDER #:</b> 10697      <b>SUGG LIST:</b> \$10.95</p>
<p>Engine stop cable replaces Murray 1101366. Fits 22" walkbehind mowers with Tecumseh engines made from 2000-2003. 3/16" Z bend on each end.</p>	<p>Engine stop cable replaces Murray 43828. Fits 22" walkbehind mowers, braided cable with die cast Z-bend on one end, T on other end.</p>
 <p style="text-align: center;">Conduit 33-1/8" Inner Wire 35" Wire Travel 1-1/2"</p>	 <p style="text-align: center;">Conduit 60" Inner Wire 62-1/2" Wire Travel 2-1/2"</p>
<p><b>ORDER #:</b> 10748      <b>SUGG LIST:</b> \$20.43</p>	<p><b>ORDER #:</b> 11516      <b>SUGG LIST:</b> \$10.01</p>
<p>Choke control cable replaces Scag 482314. Fits 48" &amp; 52" SW &amp; SWZ walkbehind units.</p>	<p>Throttle cable replaces MTD 746-0841. Fits model series 370-389, 559, 959, 979, E979 &amp; 999, 1997- 2002 push and self propelled units. "Z" bend on end.</p>
 <p style="text-align: center;">Conduit 42" Inner Wire 44-1/2" Wire Travel 2-1/2"</p>	 <p style="text-align: center;">Conduit 29" Inner Wire 32" Wire Travel 1-1/2"</p>
<p><b>ORDER #:</b> 11518      <b>SUGG LIST:</b> \$15.29</p>	<p><b>ORDER #:</b> 11519      <b>SUGG LIST:</b> \$15.89</p>
<p>Throttle cable replaces MTD 746-0847 / 746-1115. Fits models 12A-998Q401, 11A-418Q118 &amp; 12A-378Q118 Yardman. "Z" bend on end.</p>	<p>Choke cable replaces MTD 746-3021. Fits models 662-672 &amp; 678. "Z" bend on end.</p>
 <p style="text-align: center;">Conduit 45" Inner Wire 50" Wire Travel 4-1/4"</p>	 <p style="text-align: center;">Conduit 54" Inner Wire 56-1/4" Wire Travel 2-1/4"</p>
<p><b>ORDER #:</b> 12053      <b>SUGG LIST:</b> \$19.99</p>	<p><b>ORDER #:</b> 12218      <b>SUGG LIST:</b> \$30.91</p>
<p>Throttle cable replaces Dixie Chopper 68249. Will not fit older style with loop.</p>	<p>Throttle cable replaces Exmark 1-633696. Fits Metro HP, Turf Tracer, Viking, Lazer &amp; Turf Ranger models.</p>

 <p>Conduit 54" Inner Wire 58-3/4"</p>	 <p>Conduit 53-1/2" Wire Travel 1-1/2"</p>
<p><b>ORDER #:</b> 13014      <b>SUGG LIST:</b> \$24.66</p>	<p><b>ORDER #:</b> 13478      <b>SUGG LIST:</b> \$23.16</p>
<p>Choke control cable replaces Exmark 1-603336. Fits models 52" &amp; 60" Turf Tracer Hydro drive units with floating decks.</p>	<p>Throttle cable replaces Exmark 116-0969. Fits Lazer Z models.</p>
 <p>Conduit 61" Inner Wire 63" Wire Travel 2"</p>	
<p><b>ORDER #:</b> 14621      <b>SUGG LIST:</b> \$26.11</p>	<p><b>ORDER #:</b> 245      <b>SUGG LIST:</b> \$9.25</p>
<p>Choke control cable replaces Cub Cadet 746-04214, 946-04214. Fits RZT50/54 mowers.</p>	<p>.058" Standard throttle wire, comes in 100' rolls only. Used with our 03-247 conduit.</p>
	
<p><b>ORDER #:</b> 247      <b>SUGG LIST:</b> \$28.05</p>	<p><b>ORDER #:</b> 249      <b>SUGG LIST:</b> \$0.75</p>
<p>.188" Standard conduit, comes in 50' rolls only. Used with our 03-245 inner wire.</p>	<p>(For 3/16" cable) bolt on, Zinc plated.</p>
	
<p><b>ORDER #:</b> 250      <b>SUGG LIST:</b> \$2.00</p>	<p><b>ORDER #:</b> 252      <b>SUGG LIST:</b> \$0.75</p>
<p>Bolt on. Used to clamp throttle cable to engine. Zinc plated. Complete with screw. Replaces Briggs &amp; Stratton 22372 &amp; 692179.</p>	<p>(For 7/8" tubing) clamp on, Zinc plated. For holding conduit to handle.</p>

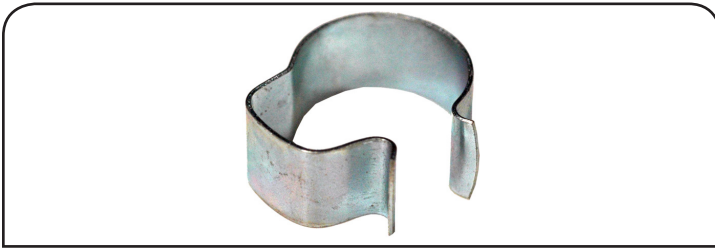

**ORDER #:** 2702

**SUGG LIST:** \$1.25

(For 7/8" tubing) clamp on, Zinc plated. Holds two 1/4" cables to handle.



**ORDER #:** 8417

**SUGG LIST:** \$11.91

Throttle control handle replaces MTD 831-0796A. Fits 36" cut model 132-431-E06, 38" cut models 132-657-F062, 139-652-352 & 46" cut model 140-848-H062.



**ORDER #:** 8800

**SUGG LIST:** \$1.29

T - knob replaces Bunton PL4020. Fits our 03-8766 throttle control.



**ORDER #:** 10855

**SUGG LIST:** \$3.10

Conduit clip replaces Honda 16516-891-000. Fits GX 110, 120, 140, 160.

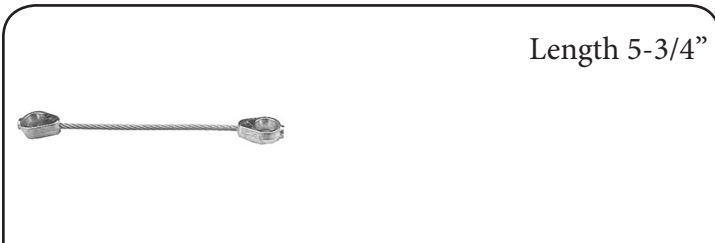

Length 5-3/4"

**ORDER #:** 10686

**SUGG LIST:** \$6.87

Brake cable replaces MTD 746-0970. Fits 42" deck mowers. 3/8" eyelets on each end.

# Go Kart Parts

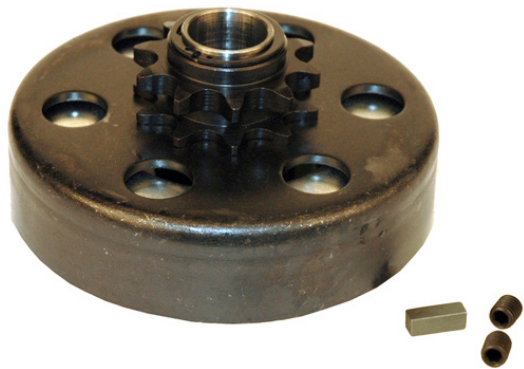

## GO KART PARTS ..... 42

- » *Throttle Controls*..... 43
- » *Go Kart Throttle & Brake Cables*..... 43
- » *Cable Stops*..... 44
- » *Go Kart Clutches* ..... 44
- » *Go Kart Racing Clutches*..... 45
- » *Torq Converter Driver Unit* ..... 45
- » *Drive Sprockets* ..... 45
- » *Clutch Bushings* ..... 45
- » *Drive Sprockets* ..... 46
- » *Key Stock*..... 46
- » *Brake Pucks*..... 46
- » *Brake Drum* ..... 46
- » *Clutch Collars* ..... 47
- » *Brake Band* ..... 47
- » *Sprockets* ..... 47

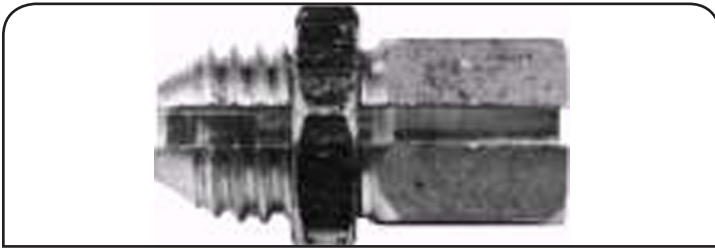

**ORDER #:** 268

**SUGG LIST:** \$2.19

This ferrule is used on many twist grips to hold the housing in place.

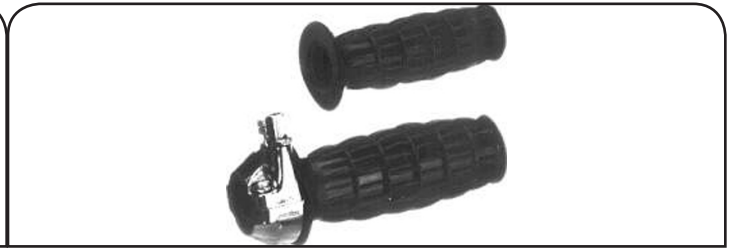

**ORDER #:** 257

**SUGG LIST:** \$26.00

(For 7/8" handle)

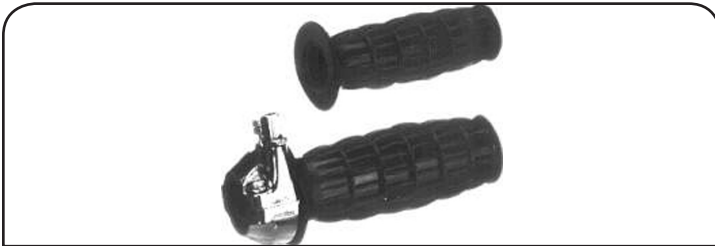

**ORDER #:** 258

**SUGG LIST:** \$26.00

(For 1" handle)



**ORDER #:** 261

**SUGG LIST:** \$3.03

48" innercable, 43" outercasing.



**ORDER #:** 262

**SUGG LIST:** \$3.14

53" innercable, 48" outercasing.



**ORDER #:** 263

**SUGG LIST:** \$3.25

60" innercable, 55" outercasing.



**ORDER #:** 264

**SUGG LIST:** \$3.85

This is a universal brake cable which has a 65" innercable and a 60" outercasing. Heavy duty long wear.

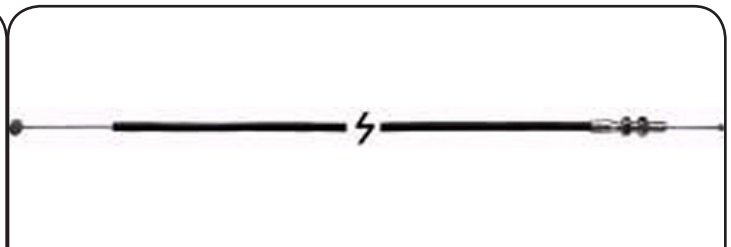

**ORDER #:** 266

**SUGG LIST:** \$7.70

These brake cables work on mini-bikes using disc brakes. Comes complete with spring and U-clamp. With 56" cable.



**ORDER #:** 219

**SUGG LIST:** \$0.79

**ORDER #:** 267

**SUGG LIST:** \$0.79

Wire stop. Used for securing inner wire to engine.

This universal wire stop will work on 03-261, 03-269 and 03-263 throttles and 264 brake cables. It will also work as a wire swivel.



**ORDER #:** 269

**SUGG LIST:** \$7.15

**ORDER #:** 455

**SUGG LIST:** \$47.50

Combination ball-barrel ends. For use on all terrain vehicles. 100" innercable and 90" outercasing.

3/4" Bore, 35 Chain, 12 teeth.



**ORDER #:** 456

**SUGG LIST:** \$47.50

**ORDER #:** 457

**SUGG LIST:** \$47.50

5/8" Bore, 35 Chain, 11 teeth.

3/4" Bore, 40, 41 Chain, 10 teeth.



**ORDER #:** 864

**SUGG LIST:** \$79.50

**ORDER #:** 865

**SUGG LIST:** \$79.50

Bore 3/4", For either A or B section belt. Pulley is 3.20" OD.

Bore 5/8", For either A or B section belt. Pulley is 3.20" OD.



**ORDER #:** 10389      **SUGG LIST:** \$79.95

Bore 3/4", Chain type No. 35, 12 Teeth.



**ORDER #:** 10390      **SUGG LIST:** \$79.95

Bore 3/4", Chain type No. 41, 10 Teeth.

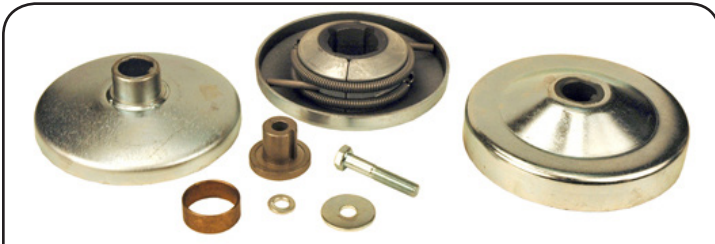

**ORDER #:** 13988      **SUGG LIST:** \$138.95

Max-Torque TCDRS34 Torque Converter Driver Unit. Symmetrical, 3/4" shaft, 5" diameter. Includes a 5/16" - 24 x 1-3/4" bolt, lock washer and flat washer. Replaces Comet 219559. Uses 11/16" belt



**ORDER #:** 462      **SUGG LIST:** \$21.00

3/4" ID for 5/8 clutch, 35 roller chain, 11 Tooth.

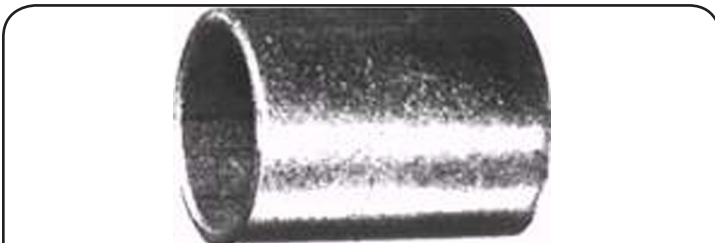

**ORDER #:** 465      **SUGG LIST:** \$4.35

For 3/4" clutch. (7/8" ID)

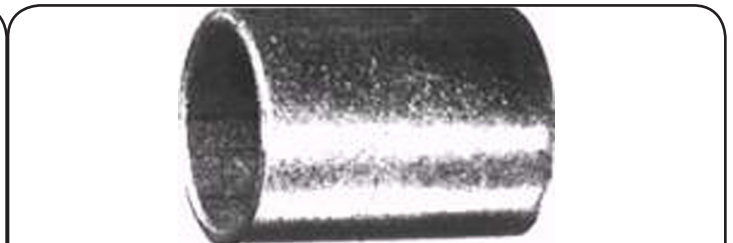

**ORDER #:** 466      **SUGG LIST:** \$4.35

For 5/8" clutch. (3/4" ID)











**ORDER #:** 475      **SUGG LIST:** \$11.55







9 tooth for 41 chain.



**ORDER #:** 476      **SUGG LIST:** \$12.10

10 tooth for 41 chain.

			
<b>ORDER #:</b> 485	<b>SUGG LIST:</b> \$6.60	<b>ORDER #:</b> 461	<b>SUGG LIST:</b> \$0.79
This 4" steel Brake Drum has the popular Indus pattern and universal mounting holes 5/16" and 3/8".		Centrifugal clutch key 3/16" x 3/4". Replaces MTD 914-0122 & 714-0122	
			
<b>ORDER #:</b> 490	<b>SUGG LIST:</b> \$5.75	<b>ORDER #:</b> 10191	<b>SUGG LIST:</b> \$13.50
Flat-End type, used on our 488.		Brake replacement pucks for our 9306 disc brake. 2 pucks per bag. Size: 1.3" H x 1.6" W x .350" Th.	
			
<b>ORDER #:</b> 5600	<b>SUGG LIST:</b> \$1.99	<b>ORDER #:</b> 5601	<b>SUGG LIST:</b> \$2.79
3/16" - 12" length. (green)		1/4" - 12" length. (blue)	
			
<b>ORDER #:</b> 5602	<b>SUGG LIST:</b> \$3.69	<b>ORDER #:</b> 5603	<b>SUGG LIST:</b> \$4.09
5/16" - 12" length. (red)		3/8" - 12" length. (yellow)	

			
<b>ORDER #:</b> 7329	<b>SUGG LIST:</b> \$2.89	<b>ORDER #:</b> 9263	<b>SUGG LIST:</b> \$2.59
1" Lock Collar. 5/8" Height.		7/8" Locking shaft collar. 9/16" height, 1-31/64" OD.	
			
<b>ORDER #:</b> 486	<b>SUGG LIST:</b> \$25.45	<b>ORDER #:</b> 8200	<b>SUGG LIST:</b> \$6.25
Brake band and pin for our 485 brake drum.		Brake band pin only for our 486.	
			
<b>ORDER #:</b> 9484	<b>SUGG LIST:</b> \$18.00	<b>ORDER #:</b> 469	<b>SUGG LIST:</b> \$15.75
60 Tooth, 7-1/4" OD, 1-3/8" ID.		60 Tooth, 7-1/4" OD.	

# Wheels & Tires





## WHEELS & TIRES ..... 55

- » *Valve Stems* .....56
- » *Trailer Tires*.....56
- » *Valve Stems:*.....56
- » *Trailer Tires:*.....56
- » *Wheel assemblies:*.....57
- » *Wheel Assemblies* .....57
- » *Rims:* .....59
- » *Rims* .....59
- » *Pneumatic Tires*.....60
- » *Carlisle Tires* .....62

VALVE STEMS:

			
<b>ORDER #:</b> 364	<b>SUGG LIST:</b> \$1.00	<b>ORDER #:</b> 368	<b>SUGG LIST:</b> \$1.49
Long valve stem 1-13/16", core and cap (TR-413).		Short valve stem 1-7/16", core and cap (TR-412).	

TRAILER TIRES:

			
<b>ORDER #:</b> 837	<b>SUGG LIST:</b> \$33.69	<b>ORDER #:</b> 838	<b>SUGG LIST:</b> \$52.89
400x400x8 Sawtooth / 4 ply tubeless high speed tire. Cheng Shin		570x500x8 Sawtooth/ 4 ply tubeless high speed tire. Cheng Shin	
			
<b>ORDER #:</b> 841	<b>SUGG LIST:</b> \$63.32		
530 x 12 Sawtooth/ 4 ply tubeless high speed tire. Cheng Shin			



**ORDER #:** 872

**SUGG LIST:** \$43.45

**ORDER #:** 13402

**SUGG LIST:** \$22.79

6" centered hub, 5/8" x 1-3/8" bearing. 480x400x8 Pneumatic Tire. Uses our 326 Bearing.

Tire skin 8" new style replaces Toro 53-7740. Front and rear tire only for commercial mowers.

***WHEEL ASSEMBLIES:***



**ORDER #:** 3276

**SUGG LIST:** \$82.29

**ORDER #:** 7285

**SUGG LIST:** \$49.95

9x350x4 smooth tread 4-ply tubeless tire. 4" Centered 3 piece rim, zerk fitting and a 5/8" open roller cage bearing. Painted Orange

410x350x4 Wheel Assembly. Replaces Snapper 7052267. One piece rim, zerk fitting, tubless turf tread. Uses 7328 tire. Painted Gray. Bearing included. 3-1/4" hub length. 10-1/2" height.



**ORDER #:** 8278

**SUGG LIST:** \$41.95

**ORDER #:** 8494

**SUGG LIST:** \$86.70









410x4, 2 ply stud tread tubless tire. 3-1/4" offset hub with zerk fitting and 3/4" bearings. Painted White. One piece rim



9x350x4 Caster Wheel. Smooth Tread. Solid Foam. 3 piece rim. 3-1/4" centered hub with 3/4" open cage roller bearing and zerk fitting. Painted White. Rim is 8376. Foam 8264

# WHEELS & TIRES





Section





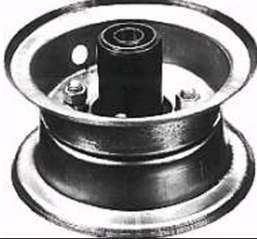











	
<b>ORDER #:</b> 8552 <b>SUGG LIST:</b> \$65.00	<b>ORDER #:</b> 8575 <b>SUGG LIST:</b> \$86.00
9x350x4 Caster Wheel, 4 ply smooth tread tubeless tire, 1 piece rim, 3-1/2" centered hub, with 5/8" semi-sealed bearing and zerk fitting (painted tan).	9x350x4, 4 ply traction tire w/ tube, 3-1/2" centered hub, 3 piece rim, 3/4" open cage roller bearing and zerk fitting. Fits all one wheel Velke's. Repl tire 8636. With bushing (painted white).
	
<b>ORDER #:</b> 9605 <b>SUGG LIST:</b> \$147.38	<b>ORDER #:</b> 9763 <b>SUGG LIST:</b> \$125.19
13x500x6 Caster wheel. 4 ply smooth tread tubeless tire, 1 piece rim, 5/8" open cage roller bearing and zerk fitting. (painted gold) Hub length 5-7/8"	13x500x6 Caster wheel. 4 ply tubeless rib tread tire, 3-1/2" centered hub, 1 pce rim with zerk fitting (painted silver). Uses 9719 wheel bearing kit. No Bearings Included.
	
<b>ORDER #:</b> 9809 <b>SUGG LIST:</b> \$225.88	<b>ORDER #:</b> 10106 <b>SUGG LIST:</b> \$60.45
13x500x6 Solid wheel assembly with bearings, 1 piece rim, 5-5/8" centered hub, 3/4" bearings with zerk fitting (painted white). Includes our 813 bearings.	11x400x4, 4 ply front wheel assembly. One piece rim with 3/4" bearing, zerk fitting, tubeless turf tire (painted Grey).
	
<b>ORDER #:</b> 10288 <b>SUGG LIST:</b> \$147.56	<b>ORDER #:</b> 11061 <b>SUGG LIST:</b> \$150.52
13x500x6 Reliance tire on a 6 x 3.25" steel wheel. 5.625" centered hub with 3/4" cups (painted White). Uses our 813 bearing or our 9944 bearing kit. No Bearings Included.	15x600x6 Reliance tire on a 6" x 4.5" steel wheel painted silver with 3-3/4" centered hub length. No Bearings Included.

			
<b>ORDER #:</b> 13421	<b>SUGG LIST:</b> \$52.73	<b>ORDER #:</b> 14814	<b>SUGG LIST:</b> \$180.34
4.10/3.50-4 smooth tread tubeless tire, 3/4" ID x 4-1/4" hub length with zerk fitting. Front wheel and tire assembly replaces Toro 110-6785.		13x650x6 Smooth tread, flat proof semi pneumatic wheel assembly. With cup bearing x 6.75" sym hub length. Includes Exmark 1-633584 bearing cup. Must use OEM bearing components.	

**RIMS:**

			
<b>ORDER #:</b> 371	<b>SUGG LIST:</b> \$62.50	<b>ORDER #:</b> 8379	<b>SUGG LIST:</b> \$23.38
4" Front wheel & hub assembly. Uses 8199 bearings		6" Diameter x 4-1/2" rim width x 2" hub length. 1 pc Universal wheel with a 2" offset hub. Fits 1-3/8" bearings. Painted White	
			
<b>ORDER #:</b> 8981	<b>SUGG LIST:</b> \$32.95	<b>ORDER #:</b> 8982	<b>SUGG LIST:</b> \$40.95
5" diameter x 2-3/4" rim width x 2-1/4" centered hub length. 2 piece wheel without bearings. Uses our 325, 326, & 327 bearings. (white)		6" diameter x 3-1/4" rim width x 2-5/8" centered hub length. 2 piece wheel without bearings. Uses our 325, 326, & 327 bearings. (white) 6 bolt pattern	

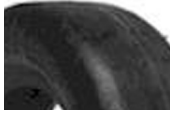
Part Number	Description	Sugg. List	
302	20x2.125 Stud Tread-Heavy Duty. Cheng Shin.	\$12.80	
303	16x2.125 Stud Tread-Heavy Duty. Cheng Shin.	\$9.86	
341	410x350x4 Stud / 2 Ply Tube Type Fits Snapper 7010820. Cheng Shin.	\$12.76	
342	410x350x5 Stud / 2 Ply Tube Type. Cheng Shin.	\$14.56	
343	410x350x6 Stud / 2 Ply Tube Type. Cheng Shin.	\$15.98	
344	480x400x8 Stud / 2 Ply Tube Type Fits Snapper 7010524. Cheng Shin.	\$27.48	
10428	200x50, knobby tread tire. 4" rim size, 8" H, 2" W Cheng Shin.	\$8.74	
7827	20x8x10 Turf Tread / 4 Ply Tubeless. Cheng Shin.	\$72.86	
9325	20x10.00x10 Turf Tread / 4 Ply Tubeless. Cheng Shin.	\$93.94	
8925	16x800x7 Compass Stud Tread / 2 Ply Tubeless Cheng Shin.	\$49.23	
6594	145x70x6, 2 ply tubeless knobby tread tire. Cheng Shin.	\$29.69	
9324	530x450x6, 2 ply tube type knobby tread tire. Cheng Shin.	\$24.00	
8924	410x350x6, 4 ply tube type knobby tread tire. Cheng Shin.	\$20.06	
8582	8x300x4 Turf Tread / 4 Ply Tube Type Fits Toro 68-8970. Cheng Shin.	\$11.88	
8636	9x350x4 Turf Tread / 4 Ply Tubeless Traction Tread Tire, Cheng Shin.	\$14.52	
7328	410x350x4 Turf Tread / 2 Ply Tubeless, Cheng Shin.	\$15.78	
828	11x400x5 Turf Tread / 2 Ply Tubeless, Cheng Shin.	\$15.97	
883	13x650x6 Turf Tread / 4 Ply Tubeless, Cheng Shin.	\$33.48	
6540	14x500x6 Turf Tread / 2 Ply Tubeless, Cheng Shin.	\$54.28	
10756	15x6.00x6, 4-ply tubeless Turf Tread tire. Cheng Shin.	\$39.66	
347	16x650x8 Turf Tread / 2 Ply Tubeless, Cheng Shin.	\$43.78	
8542	16x650x8 Turf Tread / 4 Ply Tubeless, Cheng Shin.	\$44.71	
6541	16x750x8 Turf Tread / 2 Ply Tubeless, Cheng Shin.	\$51.35	
3275	18x650x8 Turf Tread / 4 Ply Tubeless, Cheng Shin.	\$64.34	
362	18x850x8 Turf Tread / 4 Ply Tubeless Kenda.	\$56.06	
348	18x950x8 Turf Tread / 4 Ply Tubeless Cheng Shin.	\$109.78	
5891	20x1000x10 Turf Tread / 4 Ply Tubeless Kenda K367 Grasshopper.	\$88.71	
13165	24x12.00x12 Turf Tread / 4 Ply Tubeless Cheng Shin.	\$159.78	

Part Number	Description	Sugg. List	
921	23x850x12 Kenda Turf Boss / Turf Trac 4 Ply Tubeless	\$89.60	
913	23x1050x12 Kenda Turf Boss / Turf Trac 4 Ply Tubeless	\$99.57	
14233	20x10.50x8 Kenda Super Turf Tread /4 Ply Tubeless	\$96.68	
13662	22x10.00x10 Kenda Super Turf Tread 4 Ply Tubeless	\$102.68	
14556	23x9.50x12 Kenda Super Turf Tread/ 4 Ply Tubeless	\$81.91	
14542	24x12.00x12 Kenda Super Turf Tread /4 Ply Tubeless	\$125.38	
14678	24x9.50x12 Kenda 4 Ply Tubeless Tire. Super Turf Tread	\$102.40	
14680	22x9.50x12 Kenda 4 ply tubeless tire. Super Turf Tread	\$96.58	
14754	18x8.50x8 Kenda 4 Ply tubeless tire. Super Turf Tread	\$60.95	
829	13x500x6 Rib / 2 Ply Tubeless, Cheng Shin.	\$21.05	
830	15x600x6 Rib / 2 Ply Tubeless, Cheng Shin.	\$33.97	
833	16x650x8 Rib / 2 Ply Tubeless, Cheng Shin.	\$43.29	
8514	11x400x5 Rib / 4 Ply Tubeless, Cheng Shin.	\$13.48	
10098	15x600x6 Rib / 4Ply Tubeless, Cheng Shin.	\$32.83	
10430	13x6.5x6, Rib / 4 Ply Tubeless , Chen Shin	\$26.31	
10809	10x3.00x4, Kenda Rib / 4-ply Tubless Tire.	\$16.12	
879	280x250x4 Kenda Saw Tooth / 2 Ply Tubeless	\$13.14	
8194	8x300x4 Smooth / 4 Ply Tube Type, Cheng Shin.	\$13.69	
908	9x350x4 Smooth / 4 Ply Tubeless Cheng Shin.	\$14.49	
349	410x350x4 Slick/Smooth / 4 Ply Tube Type Tire Cheng Shin.	\$18.06	
350	410x350x5 Slick/Smooth / 4 Ply Tube Type Tire Cheng Shin.	\$21.51	
351	410x350x6 Slick/Smooth / 4 Ply Tube Type Tire Cheng Shin.	\$23.75	
9323	12x600x6 Slick/Smooth / 2 Ply Tube Type Cheng Shin.	\$28.98	
8949	13x500x6 Smooth / 4 Ply Tubeless, Cheng Shin.	\$29.91	
9201	13x650x6 Smooth / 4 Ply Tubeless, Cheng Shin.	\$31.48	
11563	22x11.00x10 Kenda Bar Tread / 4 Ply Tubeless	\$105.42	
8941	18x850x8 Hole-In-One Tread / 4 Ply Tubeless Kenda	\$57.45	

Part Number Description Sugg. List

## CARLISLE TIRES

14911	18x8.50-8, 4 ply tubeless tire. Turf Smart Tread.	\$112.45
14912	18x8.50-10, 4 ply tubeless tire. Turf Smart Tread.	\$114.62
14914	20x10.00-8, 4 ply tubeless tire. Turf Smart Tread.	\$138.88
14915	20x10.00-10, 4 ply tubeless tire. Turf Smart Tread.	\$139.99
14917	22x9.50-12, 4 ply tubeless tire. Turf Smart Tread.	\$137.77
14918	23x9.50-12, 4 ply tubeless tire. Turf Smart Tread.	\$146.87
14919	23x10.50-12, 4 ply tubeless tire. Turf Smart Tread.	\$152.25
14920	24x9.50-12, 4 ply tubeless tire. Turf Smart Tread.	\$161.44
14921	24x12.00-12, 4 ply tubeless tire. Turf Smart Tread.	\$164.37



8939	18x850x8 4 Ply Tubeless Tire	\$101.66
------	------------------------------	----------

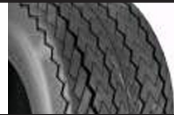





8923	18x850x8 4 Ply Tubeless Tire	\$81.14
------	------------------------------	---------









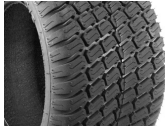

9711	13x650x6 Turf Master / 4 Ply Tubeless Tire	\$63.48
9185	15x600x6 Turf Master / 4 Ply Tubeless Tire	\$61.54
12478	15x650x8 Turf Master / 2 Ply Tubeless Tire	\$66.28
9186	16x650x8 Turf Master / 4 Ply Tubeless Tire	\$78.95
9187	16x750x8 Turf Master / 4 Ply Tubeless Tire	\$91.78
9888	18x650x8 Turf Master / 4 Ply Tubeless Tire	\$107.91
9188	18x850x8 Turf Master / 4 Ply Tubeless Tire	\$112.25
9966	18x950x8 Turf Master / 4 Ply Tubeless Tire	\$112.50
9189	20x10.00x8 Turf Master / 4 Ply Tubeless Tire	\$141.66
10127	20x1000x10 Turf Master / 4 Ply Tubeless Tire	\$143.82
13245	22x9.50x12 Turf Master / 4 ply Tubeless Tire	\$144.89
14002	22x10.50x12 Turf Master / 4 ply Tubeless Tire	\$128.58
11221	22x11.00x10 Turf Master / 4 ply Tubeless Tire	\$151.66
12310	22x12.00x8 Field Trax Tread / 3 ply Tubeless Tire	\$172.89
10214	23x8.50x12 Turf Master / 4 ply Tubeless Tire	\$140.46
9744	23x950x12 Turf Master / 4 Ply Tubeless Tire	\$153.85
9190	23x10.50x12 Turf Master / 4 Ply Tubeless Tire	\$154.52
9283	24x12.00x12 Turf Master / 4 Ply Tubeless Tire	\$171.45
12244	20x8x10 Turf Master / 4 Ply Tubeless Tire	\$105.29
12524	24x9.50x12 Turf Master / 4 Ply Tubeless Tire	\$167.29



Part Number	Description	Sugg. List	
<b><i>CARLISLE TIRES</i></b>			
5916	410-4 (410x350x4) Stud / 2 Ply Tubeless Tire	\$24.55	
5917	410-5 (410x350x5) Stud / 2 Ply Tubeless Tire	\$24.58	
5918	410-6 (410x350x6) Stud / 2 Ply Tubeless Tire	\$28.89	
5948	480-8 (480x400x8) Stud / 2 Ply Tubeless Tire	\$37.91	
8006	410-4 (410x4) Snow Hog / 2 Ply Tubeless Tire	\$27.08	
8007	410-6 (410x6) Snow Hog / 2 Ply Tubeless Tire	\$33.24	
8915	13x500x6 Snow Hog / 2 Ply Tubeless Tire	\$37.91	
9549	15x500x6 Snow Hog / 2 Ply Tubeless Tire	\$43.11	
8918	16x650x8 Snow Hog / 2 Ply Tubeless Tire	\$55.45	
8919	480x8 Snow Hog / 2 Ply Tubeless Tire	\$44.62	
7700	15x600x6 Turf Mate / 2 Ply Tubeless Tire	\$42.80	
7699	20x800x8 Turf Mate / 2 Ply Tubeless Tire	\$104.62	
8084	20x10x8 Turf Mate / 4 Ply Tubeless Tire	\$122.40	
6832	22x11.00x8 Turf-CTR / 4 Ply Tubeless Tire	\$117.29	
7022	13x500-6 Rib / 2 Ply Tubeless Tire	\$32.09	
8456	13x500x6 Rib / 4 Ply Tubeless Tire	\$40.52	
9500	13x650x6 Rib / 4 Ply Tubeless Tire.	\$47.94	
7026	15x600-6 Rib / 4 Ply Tubeless Tire	\$52.06	
7027	16x650-8 Rib / 4 Ply Tubeless Tire	\$78.55	
903	400x6 Wheel Barrow / 2 Ply Tubeless Tire	\$19.72	
361	480-8 Wheel Barrow / 2 Ply Tubeless Tire	\$21.23	
906	410 - 4 (410x350x4) Sawtooth / 2 Ply Tubeless Tire	\$21.17	
8917	410x6 Sawtooth / 4 Ply Tubeless Tire	\$44.80	
8539	530x450x6 Sawtooth / 6 Ply Tubeless Tire	\$71.26	
7023	13x500-6 Super Lug / 2 Ply Tubeless Tire	\$36.96	
9495	16x650x8 Super Lug / 4 Ply Tubeless Tire	\$86.95	
5894	480-8 (480x400-8) Super Lug / 2 Ply Tubeless Tire	\$44.06	
8688	20x10.00x8 Super Lug / 4 Ply Tubeless Tire	\$127.69	

Part Number	Description	Sugg. List		
<b><i>CARLISLE TIRES</i></b>				
8687	23x10.50x12 Tru Power Tread / 4 Ply Tubeless Tire	\$218.77		
9154	23x850x12 Tru Power Tread / 4 Ply Tubeless Tire	\$173.85		
8896	21x11x8 AT 101 Tread / 4 Ply Tubeless Tire	\$126.55		
10193	21x11x10 Titan/Chevron AT101/ 4 ply Tubeless Tire	\$182.22		
11809	24x12.00x12 Chevron tread / 4 Ply belted	\$199.90		
8920	15x600x6 Turf Saver II / 2 Ply Tubeless Tire	\$40.46		
8082	16x650x8 Turf Saver II / 2 Ply Tubeless Tire	\$49.42		
8083	18x850x8 Turf Saver II / 2 Ply Tubeless Tire	\$87.48		
9881	4.10x4 Turf Saver / 2 Ply Tubeless Tire	\$25.88		
7694	11x400x4 Turf Saver / 2 Ply Tubeless Tire	\$27.88		
8540	11x400x5 Turf Saver / 2 Ply Tubeless Tire	\$29.02		
359	13x500x6 Turf Saver / 2 Ply Tubeless Tire	\$31.63		
8457	13x500x6 Turf Saver / 4 Ply Tubeless Tire	\$41.26		
5945	13x650x6 Turf Saver / 2 Ply Tubeless Tire	\$44.12		
7025	13x650x6 Turf Saver / 4 Ply Tubeless Tire	\$51.91		
346	15x600x6 Turf Saver / 2 Ply Tubeless Tire	\$41.50		
5947	16x650x8 Turf Saver / 2 Ply Tubeless Tire	\$47.97		
7028	16x650x8 Turf Saver / 4 Ply Tubeless Tire	\$61.63		
8541	16x750x8 Turf Saver / 2 Ply Tubeless Tire	\$57.60		
12671	18x7.50x8 Turf Saver / 4 Ply Tubeless Tire	\$85.85		
7029	18x850x8 Turf Saver / 4 Ply Tubeless Tire	\$98.58		
7030	18x950x8 Turf Saver / 4 Ply Tubeless Tire	\$106.68		
7695	18x950x8 Turf Saver / 2 Ply Tubeless Tire	\$92.06		
7201	20x8x8 Turf Saver / 2 Ply Tubeless Tire	\$104.98		
7202	20x10x8 Turf Saver / 2 Ply Tubeless Tire	\$118.12		
7031	20x10.00x10 Turf Saver / 4 Ply Tubeless Tire	\$137.51		
10970	21x7x10 Turf Saver / 2 Ply Tubeless Tire	\$125.57		
11059	22x950x12 Turf Saver / 2 Ply Tubeless Tire	\$128.49		
7696	23x950x12 Turf Saver / 2 Ply Tubeless Tire	\$136.89		
7033	23x10.50x12 Turf Saver / 4 Ply Tubeless Tire	\$167.11		
9494	11x400x5 Smooth Tread / 4 Ply Tubeless Tire	\$36.37		
8888	18x950x8 Smooth Tread / 4 Ply Tubeless Tire	\$101.78		

Part Number	Description	Sugg. List	
<b><i>CARLISLE TIRES</i></b>			
10289	13x5.00x6 4 ply smooth Tubeless Tire	\$46.96	
10290	13x6.50x6 4 ply smooth Tubeless Tire	\$54.25	
12795	18x8.50x10 Multi-Trac / 4 Ply Tubeless Tire	\$125.05	
7049	18x10.50x10 Multi-Trac / 4 Ply Tubeless Tire	\$126.71	
11471	18x8x10 Multi-Trac / 4 Ply Tubeless Tire	\$125.05	
12879	18x7x8 Multi-Trac / 4 Ply Tubeless Tire	\$102.49	
10620	24x9.50x12 Multi-Trac / 4 Ply Tubeless Tire	\$167.35	
11509	24x12x12 Multi-Trac / 4 Ply Tubeless Tire	\$186.92	
11023	26x12x12 Multi-Trac / 4 Ply Tubeless Tire	\$199.45	
10730	20x10x10 Multi-Trac / 4 Ply Tubeless Tire	\$160.18	
12766	480-8 2 ply Tubeless X-Trac Tread Tire	\$45.60	
12765	15x5.00x6 2 ply Tubeless X-Trac Tread Tire	\$45.32	
12764	13x5.00x6 2 ply Tubeless X-Trac Tread Tire	\$38.62	
12767	16x6.50x8 2 ply Tubeless X-Trac Tread Tire	\$57.72	
10728	25x1200x9 Stryker belted, 4 ply Tubeless Tire	\$138.95	
10656	22x900x10 4 ply Tubeless Stryker I Tread ATV	\$125.75	
10660	22.5x10x8 3 ply Tubeless HD Field Trax Tire	\$202.75	
10661	25x13x9 3 ply Tubeless HD Field Trax Tire	\$149.00	
10658	18x9.50x8 2 ply tubeless Knobby Tread ATV Tire	\$68.75	
10659	22x11x8 2 ply tubeless Knobby Tread ATV Tire	\$94.75	
10725	24x9.50x10 4 ply tubeless All Trail II Tire.	\$114.85	
10726	24x10.50x10 4 ply tubeless All Trail II Tire.	\$122.44	
10731	25x1100x12 3 ply tubeless AT489 Tread Tire.	\$135.95	
10732	24x9.50x10 4 ply tubeless AT489 Tread Tire.	\$134.90	
10733	24x12.00x10 4 ply tubeless AT489 Tread Tire.	\$131.92	
10735	22.5x10.00x8 3 ply Tubeless Turf Tamer Tread Tire	\$113.40	
10736	25x12.00x9 3 ply Tubeless Turf Tamer Tread Tire	\$126.71	









# Drive Parts













## DRIVE PARTS ..... 48



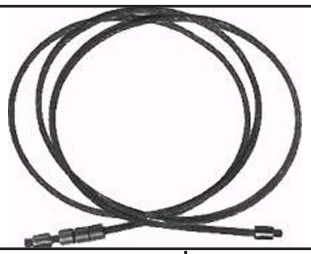
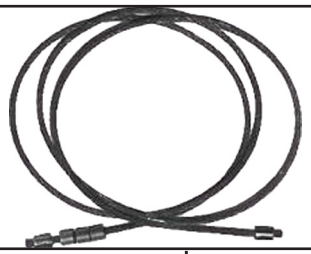



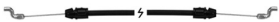
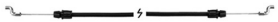
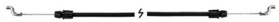
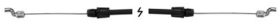
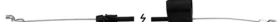

- » *Drive Gears*.....49
- » *Driven Discs*.....49
- » *Friction Drive Discs*.....50
- » *Hydro Pumps*.....51
- » *Clutch Cables*.....51
- » *Control, Brake, Engagement Cables* .....52

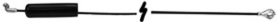

	
<p><b>ORDER #:</b> 3227      <b>SUGG LIST:</b> \$6.59</p>	<p><b>ORDER #:</b> 3244      <b>SUGG LIST:</b> \$1.50</p>
<p>Replaces MTD 731-0393.</p>	<p>Oil Fill and Check Plug. Replaces Snapper 7011024.</p>
	<p>ID 3" OD 4"</p> 
<p><b>ORDER #:</b> 6880      <b>SUGG LIST:</b> \$83.30</p>	<p><b>ORDER #:</b> 6931      <b>SUGG LIST:</b> \$1.45</p>
<p>Driven Disc Assembly replaces Snapper 7053225, 7053225, 7057444. Used on Snapper self-propelled mowers.</p>	<p>Drive Plate Bushing Only. Replaces Snapper 7013893. MIN010</p>
	<p>ID 2-1/4" OD 4-7/16"</p> 
<p><b>ORDER #:</b> 8207      <b>SUGG LIST:</b> \$4.79</p>	<p><b>ORDER #:</b> 7018      <b>SUGG LIST:</b> \$22.95</p>
<p>Drive Gear replaces Toro 39-9160. Fits models 22020, 22030, 22035 and 20680 rear wheel drive models.</p>	<p>Driven Disc replaces Noma 53830 &amp; 313883.</p>
	<p>ID 1" OD 4-3/8"</p> 
<p><b>ORDER #:</b> 7255      <b>SUGG LIST:</b> \$1.95</p>	<p><b>ORDER #:</b> 7678      <b>SUGG LIST:</b> \$24.35</p>
<p>Thrust washer replaces Snapper 7014523. Used on Snappers Smooth Clutch Assembly between disc and plate.</p>	<p>Drive disc replaces Toro 37-6570.</p>

			
<b>ORDER #:</b> 300	<b>SUGG LIST:</b> \$16.95	<b>ORDER #:</b> 301	<b>SUGG LIST:</b> \$7.95
Replaces Snapper 7010765 and Ariens Disc 3003. Jacobsen 990152, 158458, Gilson 32222, John Deere 122115, Lawnboy 741316, Murray 35550.		Replaces Snapper 7023364 & 7010927.	
			
	Outside Holes 11/32" ID 1-1/8" OD 6"		
<b>ORDER #:</b> 8898	<b>SUGG LIST:</b> \$27.15	<b>ORDER #:</b> 10169	<b>SUGG LIST:</b> \$18.95
Drive disc replaces MTD 05080A. Fits snowblower models 500, 510, 520 & 600.		Disc with liner replaces Snapper 7053103 & 7057423. Contains our 05-300 disc and 05-345 liner.	
			
			3/16" x 1-1/2"
<b>ORDER #:</b> 345	<b>SUGG LIST:</b> \$4.99	<b>ORDER #:</b> 8052	<b>SUGG LIST:</b> \$2.75
Lining only. Replaces liner in Snapper 7057423. Non-Asbestos.		Drive pulley key replaces B&S 91539. Fits B&S models 2 thru 18 hp.	
			
<b>ORDER #:</b> 8632	<b>SUGG LIST:</b> \$2.10	<b>ORDER #:</b> 8665	<b>SUGG LIST:</b> \$3.85
Oil seal replaces Snapper 7011817. Rear axle oil seal for rear engine riders. ID 1-1/16", OD 1-13/16.		Oil seal replaces Snapper 7014662. Left rear wheel oil seal on 25", 26", 28", 30" & 33" cut rear engine riders. ID 11/16", OD 1-27/32".	

 <p>.125" x .187" x .425"</p>			
<b>ORDER #:</b> 8770	<b>SUGG LIST:</b> \$1.50	<b>ORDER #:</b> 10862	<b>SUGG LIST:</b> \$59.50
Wheel drive key replaces Toro 39-9680. Fits Toro Proline 21" self propelled mowers. Used with our 05-8207 wheel drive gear.		Blade brake clutch plate replaces Honda 75150-VA3-J01, 75150-VK6-000. Fits Honda walkbehind mowers.	
 <p>Right</p>		 <p>Left</p>	
<b>ORDER #:</b> 12092	<b>SUGG LIST:</b> \$534.98	<b>ORDER #:</b> 12093	<b>SUGG LIST:</b> \$534.98
Hydrostatic Pump replaces Dixie Chopper 65		Hydrostatic Pump replaces Dixie Chopper 65071. Also replaces Hydro-Gear BDP-10A-207 & 201 217.	
		 <p>Cable Length 38-1/4" Overall Length 43"</p>	
<b>ORDER #:</b> 12126	<b>SUGG LIST:</b> \$90.78	<b>ORDER #:</b> 5616	<b>SUGG LIST:</b> \$14.31
Drive joint assembly replaces Honda 22100-VB5-804. Fits models HRA216SXA, 215SXA & HRC216HXA.		Clutch drive cable replaces MTD 946-0898, 746-0898. Fits 600 model series snow throwers built 1995-2002 and 700 model series built in 2003. Model 312-, 313-, 314 - (1992-1994) snowthrowers.	
			
<b>ORDER #:</b> 2699	<b>SUGG LIST:</b> \$6.85	<b>ORDER #:</b> 2700	<b>SUGG LIST:</b> \$9.15
Clutch Cable. Replaces Snapper 7012605 for 33" rear engine riders. Length 55". (Black)		Clutch Cable. Replaces Snapper 7012425 for 26", 28" and 30" rear engine riders. Length 51-3/4". (Yellow)	

 <p>Conduit 36-7/8" Inner Wire 43-1/8"</p>		 <p>Length 50"</p>	
<b>ORDER #:</b> 10817	<b>SUGG LIST:</b> \$13.25	<b>ORDER #:</b> 8294	<b>SUGG LIST:</b> \$10.15
Control cable replaces MTD 746-0553. Fits 1991 and newer push mowers with B&S engine models. Z bend on each end.		Brake cable replaces Snapper 7015477. Fits Snapper rear engine riders with 33" and 41" decks and one brake/clutch pedal.	
		 <p>Conduit 43" Inner Wire 49-1/2" Wire Travel 5-1/2"</p>	
<b>ORDER #:</b> 10891	<b>SUGG LIST:</b> \$29.04	<b>ORDER #:</b> 11511	<b>SUGG LIST:</b> \$13.24
Deck engagement cable replaces AYP 175067/169676. Fits 42" riders.		Engine brake cable replaces MTD 746-0551. Fits model 440, E466 and 469 series. "Z" bend on end.	
 <p>Conduit 49" Inner Wire 53-1/2" Wire Travel 5-1/2"</p>		 <p>Conduit 40-1/2" Inner Wire 47" Wire Travel 5-1/2"</p>	
<b>ORDER #:</b> 11512	<b>SUGG LIST:</b> \$22.44	<b>ORDER #:</b> 11513	<b>SUGG LIST:</b> \$11.54
Engine brake cable replaces MTD 746-0552. Fits 1985 & up walkbehind series 030 through 100 & 200, 400 & 700. For SP series 200, 400, & 700. Push in clip with heavy "Z" bend on each end.		Engine brake cable replaces MTD 746-0554. Fits 90-96 walkbehind series 300, 400, & 500. For 98 & up series 070 & 100. For 1990 & up SP series 300, 400, & 500. Die cast "Z-Bend" on each end.	
 <p>Conduit 51" Inner Wire 55-1/2" Wire Travel 5-1/2"</p>		 <p>Conduit 48-1/4" Inner Wire 60-1/4" Wire Travel 12-1/2"</p>	
<b>ORDER #:</b> 11515	<b>SUGG LIST:</b> \$14.74	<b>ORDER #:</b> 11517	<b>SUGG LIST:</b> \$10.75
Engine brake cable replaces MTD 746-0737. For 1994-1997 walk-behind model series 070, 080, 100, 200, 400, & 500. Die cast "Z" bends on each end.		Engine brake cable replaces MTD 746-0946. Fits most side discharge mowers 1986 & prior. Snap fit to handle. "Z" bend on end.	

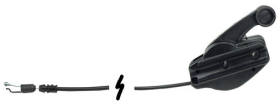
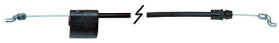
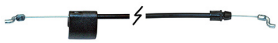
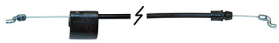
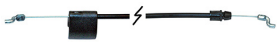
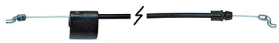
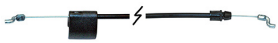
 <p style="text-align: right;">Cable Length 42"</p>	 <p style="text-align: right;">Conduit 59" Inner Wire 74" Wire Travel 4"</p>
<p><b>ORDER #:</b> 12075      <b>SUGG LIST:</b> \$9.95</p>	<p><b>ORDER #:</b> 12965      <b>SUGG LIST:</b> \$32.86</p>
<p>Drive cable replaces Snapper 70034604. Fits 21" self propelled units. Eye &amp; Z Bend endings.</p>	<p>Deck engagement cable replaces MTD 746-04173B, 746-0417A, 746-04173, 946-04173B, 946-04173A, 946-04173.</p>
 <p style="text-align: right;">Conduit 59" Inner Wire 74" Wire Travel 4"</p>	 <p style="text-align: right;">Conduit 40" Inner Wire 53"</p>
<p><b>ORDER #:</b> 13261      <b>SUGG LIST:</b> \$20.97</p>	<p><b>ORDER #:</b> 13264      <b>SUGG LIST:</b> \$9.72</p>
<p>Deck cable replaces AYP 435111, 408714, 197257, Husqvarna 532197257, 532408714, 532435111. Fits models CT126, LTH1438, LTH1538, LTH18538, YT16542, YT1942.</p>	<p>Control cable replaces MTD 746-1130 / 946-1130. Fits 22" deck, series 038, 2003-2007. Z-bend on each end.</p>
 <p style="text-align: right;">Conduit 54" Inner Wire 60" Wire Travel 6"</p>	
<p><b>ORDER #:</b> 13350      <b>SUGG LIST:</b> \$13.44</p>	<p><b>ORDER #:</b> 13380      <b>SUGG LIST:</b> \$49.95</p>
<p>Control cable replaces AYP 156581, 156577, 168552.</p>	<p>Deck engagement cable replaces AYP 193235, Poulan 532193235. Fits 38" decks. Conduit Length 29-3/4", Cable Length 45-1/8", Spring Length 6", Coil Length 5"</p>
 <p style="text-align: right;">Conduit 76" Inner Wire 79-1/2" Wire Travel 3-1/4"</p>	 <p style="text-align: right;">Conduit 25" Total Length 43"</p>
<p><b>ORDER #:</b> 13416      <b>SUGG LIST:</b> \$14.31</p>	<p><b>ORDER #:</b> 13657      <b>SUGG LIST:</b> \$23.47</p>
<p>Deck engagement cable replaces AYP 193235, Poulan 532193235. Fits 38" decks. Conduit Length 29-3/4", Cable Length 45-1/8", Spring Length 6", Coil Length 5"</p>	<p>Deck engagement cable replaces MTD 946-04092 / 746-04092. Also replaces Toro. Outer casing 26" long.</p>

 <p>Conduit 59-1/2" Inner Wire 62-1/2" Wire Travel 3"</p>		 <p>Conduit 43-3/8" Cable Length 52-1/2"</p>	
<b>ORDER #:</b> 14023	<b>SUGG LIST:</b> \$29.64	<b>ORDER #:</b> 14596	<b>SUGG LIST:</b> \$10.55
Drive cable replaces AYP/HUSQVARNA 184588, 532184588, 145755. Fits self propelled walkbehind mowers.		Zone control cable replaces AYP/Husqvarna 162778 / 176556.	
 <p>Conduit Length 46" Inner Wire 52-3/4"</p>		 <p>Conduit 46-1/4" Inner Wire 53-1/8"</p>	
<b>ORDER #:</b> 14599	<b>SUGG LIST:</b> \$10.83	<b>ORDER #:</b> 14600	<b>SUGG LIST:</b> \$9.68
Zone control cable replaces AYP/Husqvarna 183281.		Zone control cable replaces AYP/Husqvarna 440934.	
 <p>Conduit Length 48-1/2" Inner Wire 54-5/8"</p>		 <p>Conduit Length 48-1/8" Inner Wire 54-7/8"</p>	
<b>ORDER #:</b> 14601	<b>SUGG LIST:</b> \$8.58	<b>ORDER #:</b> 14602	<b>SUGG LIST:</b> \$10.49
Zone control cable replaces AYP/Husqvarna 427497.		Zone control cable replaces AYP/Husqvarna 158152.	
 <p>Conduit Length 54-1/8" Inner Wire 60-7/8"</p>		 <p>Conduit 32-1/4" Total Length 47-1/4"</p>	
<b>ORDER #:</b> 14603	<b>SUGG LIST:</b> \$9.41	<b>ORDER #:</b> 14620	<b>SUGG LIST:</b> \$14.62
Zone control cable replaces AYP/Husqvarna 183567.		Traction cable replaces Toro 106-8300. Fits super recycler mower.	

# Tubes



<b>TUBES.....</b>	<b>66</b>
» 4" Tubes.....	67
» 5" Tubes.....	67
» 6" Tubes.....	67
» 7" Tubes.....	67
» 8" Tubes.....	68
» 9" Tubes.....	68
» 10" Tubes .....	68
» 11" Tubes .....	68
» 12" Tubes .....	69
» 20" Tubes .....	69

4" TUBES

Part Number	Size	Valve Type	Sugg List
9620	410x350x4	Straight Stem	\$4.98
8694	8x300x4	L Shaped Stem	\$5.66
8694	9x350x4	L Shaped Stem	\$5.66
8694	280x250x4	L Shaped Stem	\$5.66
352	410x350x4	L Shaped Stem	\$5.60
880	280x250x-	L Shaped Parallel To Rim	\$4.12
880	4/8x300x4	L Shaped Parallel To Rim	\$4.12
3268	9x350x4	L Shaped Parallel To Rim	\$6.95
3266	410x350x4	L Shaped Parallel To Rim	\$5.63

5" TUBES

Part Number	Size	Valve Type	Sugg List
9619	410x350x5	Straight Stem	\$5.60
9619	11x400x5	Straight Stem	\$5.60
878	11x400x5	L Shaped Stem	\$6.49
353	410x350x5	L Shaped Stem	\$5.60
3267	410x350x5	L Shaped Parallel To Rim	\$5.57

6" TUBES

Part Number	Size	Valve Type	Sugg List
9621	13x500x6	Straight Stem	\$6.52
884	13x650x6	Straight Stem	\$7.69
7811	15x600x6	Straight Stem	\$8.80
7143	145x70x6	Straight Stem	\$8.77
904	400x6	Straight Stem	\$6.46
9618	410x350x6	Straight Stem	\$5.75
9618	12.5x450x6	Straight Stem	\$5.75
360	13x500x6	L-Shaped Stem	\$7.11
357	15x600x6	L-Shaped Stem	\$8.86
354	400x6	L-Shaped Stem	\$6.22
354	410x350x6	L-Shaped Stem	\$6.22
354	12.5x450x6	L-Shaped Stem	\$6.22

7" TUBES

Part Number	Size	Valve Type	Sugg List
10795	350x400x7	Straight Stem	\$7.57

8" TUBES

Part Number	Size	Valve Type	Sugg List
358	16x650x8	Straight Stem	\$10.68
358	16x750x8	Straight Stem	\$10.68
7146	18x650x8	Straight Stem	\$10.92
7146	18x750x8	Straight Stem	\$10.92
898	18x850x8	Straight Stem	\$18.37
898	18x950x8	Straight Stem	\$18.37
7260	20x10x8	Straight Stem	\$18.62
7261	20x700x8	Straight Stem	\$16.74
7261	20x8x8	Straight Stem	\$16.74
899	21x1200x8	Straight Stem	\$23.02
899	22x1100-8	Straight Stem	\$23.02
6571	300x8	Straight Stem	\$5.38
355	400x8	Straight Stem	\$7.54
355	480x400x8	Straight Stem	\$7.54
7145	570x500x8	Straight Stem	\$12.25

9" TUBES

Part Number	Size	Valve Type	Sugg List
7821	22x12x9	Straight Stem	\$31.45
900	25x1200x9	Straight Stem	\$27.88

10" TUBES

Part Number	Size	Valve Type	Sugg List
7828	20x8x10	Straight Stem	\$16.40
7828	19x800x10	Straight Stem	\$16.40
7147	20x1000x10	Straight Stem	\$21.35
7825	22x8x10	Straight Stem	\$22.06
7822	22x12x10	Straight Stem	\$32.00
7824	25x12.50x10	Straight Stem	\$31.48

11" TUBES

Part Number	Size	Valve Type	Sugg List
7826	23x8x11	Straight Stem	\$23.23
7823	24x9x11	Straight Stem	\$18.06

12" TUBES

Part Number	Size	Valve Type	Sugg List
3265	23x850x12	Straight Stem	\$23.78
3265	23x950x12	Straight Stem	\$23.78
3264	23x1050x12	Straight Stem	\$21.02
10101	24x12x12	Straight Stem	\$33.54
10959	26x12x12	Straight Stem	\$30.25
7144	480x400x12	Straight Stem	\$11.69
6627	530x450x12	Straight Stem	\$15.29

20" TUBES

Part Number	Size	Valve Type	Sugg List
304	20x2.125 Thorn Proof (HD)	Straight Stem	\$8.77
6954	20x2.125 Economy	Straight Stem	\$4.22

# Bearings & Bushings

## BEARINGS & BUSHINGS ..... 71

- » Bearings - Listed in order from ID smallest to largest.....72
- » Bushings - Listed in order from ID smallest to largest .....78

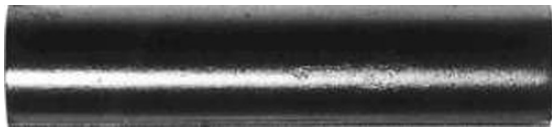

Part Number	Description	Sugg List
324	1/2" ID (12.70 mm) x 1-1/8" OD (28.58 mm) Fits 5 x 1.50, 6 x 1.75, 7 x 1.50, 7.50 x 1.50, 8 x 1.75, 10 x 1.75. Fits Murray Plastic Wheels	\$1.59
325	1/2" ID (12.70 mm) x 1-3/8" OD (34.93 mm) Fits many universal wheels.	\$2.99
326	5/8" ID (15.88 mm) x 1-3/8" OD (34.93 mm) Fits 8 x 2.75, 10 x 2.75.	\$1.99
327	3/4" ID (19.05 mm) x 1-3/8" OD (34.93 mm) Replaces Snapper No. 7011807, Toro No. 110513, 251-210.	\$3.60
9892	3/8" ID (9.53 mm) x 1-1/8" OD (28.58 mm) Fits many universal wheels.	\$1.49











Part Number	ID	OD	Height	Bearing No.	Sugg List
50187	25/64" (10 mm)	1-3/16" (30 mm)	11/32" (9 mm)	6200	\$5.79
50188	15/32" (12 mm)	1-1/4" (32 mm)	25/64" (10 mm)	6201	\$6.05
50189	37/64" (15 mm)	1-3/8" (35 mm)	7/16" (11 mm)	6202	\$6.25
50180	43/64" (17 mm)	1-3/8" (35 mm)	25/64" (10 mm)	6003	\$7.05
50181	25/32" (20 mm)	1-21/32" (42 mm)	15/32" (12 mm)	6004	\$6.05
50190	63/64" (25 mm)	2-3/64" (52 mm)	19/32" (15 mm)	6205	\$7.59
50183	1-3/16" (30 mm)	2-3/16" (55 mm)	1/2" (13 mm)	6006	\$7.49
50191	1-3/16" (30 mm)	2-7/16" (62 mm)	5/8" (16 mm)	6206	\$8.89







*BEARINGS - LISTED IN ORDER FROM ID SMALLEST TO LARGEST*

	ID 3/8" (9.53 mm) OD 1" (25.40 mm) Height 5/16" (7.94 mm)		ID 7/16" (11.11 mm) OD 1-1/8" (28.58 mm) Height 13/16" (20.64 mm)
<b>ORDER #:</b> 3229	<b>SUGG LIST:</b> \$7.25	<b>ORDER #:</b> 2703	<b>SUGG LIST:</b> \$7.75
Replaces Snapper 7028014, 12304. Hex Shaft Bearing on 21" self-propelled mowers.		For Snapper Wheels 7011125. Back to Back bearings. (Also used in our McLane Wheels).	

 <p style="margin: 0;">ID 1/2" (12.70 mm) OD 1-1/8" (28.58 mm) Height 5/16" (7.94 mm)</p>	 <p style="margin: 0;">ID 1/2" (12.70 mm) OD 1-3/8" (34.93 mm) Length 4-21/32" (118.27 mm)</p>		
<b>ORDER #: 6625</b>	<b>SUGG LIST: \$9.45</b>	<b>ORDER #: 8438</b>	<b>SUGG LIST: \$19.50</b>
Wheel bearing for Toro. Replaces Toro 52-2450. Used on 21" Toro Commercial Mowers. Bearing No. R8-2RS.		Wheel bearing kit for Exmark. Fits Exmark 1-322154. Kit contains our 09-8408 roller cage bearing with retainer bushings and 09-8409 spanner bushing.	
 <p style="margin: 0;">ID 1/2" (12.70 mm) OD 1-3/8" (34.93 mm) Height 7/16" (11.11 mm)</p>	 <p style="margin: 0;">ID 33/64" (13.10 mm) OD 11/16" (17.46 mm) Height 1/2" (12.70 mm)</p>		
<b>ORDER #: 8869</b>	<b>SUGG LIST: \$14.95</b>	<b>ORDER #: 7674</b>	<b>SUGG LIST: \$11.59</b>
Bearing replaces Ariens 54080. Fits 21" self propelled walk behind mowers with 5/8" axle. Also replaces John Deere AM122108, MTD 741-0133.		Needle bearing. Repl. Toro 48-2060. Fits 21" self-propelled commercial transmission and wheel bracket bearing.	
 <p style="margin: 0;">ID 9/16" (14.29 mm) OD 1-3/8" (34.93 mm) Height 7/16" (11.11 mm)</p>	 <p style="margin: 0;">ID 9/16" (14.29 mm) OD 3/4" (19.05 mm) Height 9/16" (14.29 mm)</p>		
<b>ORDER #: 3228</b>	<b>SUGG LIST: \$10.25</b>	<b>ORDER #: 7241</b>	<b>SUGG LIST: \$21.14</b>
Commercial Bearing. Replaces Snapper 7018767, wheel arm assembly bearing. Bearing No. SC0265LUC3.		Variator bearing. Replaces MTD 741-0404. For variable speed pulley. Fits models 600 & 659. Used on our 10-7281 shaft.	
 <p style="margin: 0;">ID 15mm (15 mm) OD 1-3/8" (34.93 mm) Height 7/16" (11.11 mm)</p>	 <p style="margin: 0;">ID 5/8" (15.88 mm) OD 1-3/8" (34.93 mm) Height 7/16" (11.11 mm)</p>		
<b>ORDER #: 7312</b>	<b>SUGG LIST: \$7.59</b>	<b>ORDER #: 481</b>	<b>SUGG LIST: \$7.95</b>
High Speed Bearing fits Echo, RedMax, Green Machine and Shindaiwa, Kawasaki chain saws, trimmers and blowers. Bearing No. 6202, open both sides.		Premium High Speed Bearing, double sealed. Replaces Snapper 7010756, Murray 326985. Bearing No. 99502H-2RS (NR)	

 <p>ID 5/8" (15.88 mm) OD 1-9/16" (39.69 mm) Height 15/32" (11.91 mm)</p>	 <p>ID 5/8" (15.88 mm) OD 7/8" (22.23 mm) Height 5/8" (15.88 mm) Flange OD 1-1/8" (28.58 mm)</p>
<p><b>ORDER #:</b> 483      <b>SUGG LIST:</b> \$11.91</p>	<p><b>ORDER #:</b> 293      <b>SUGG LIST:</b> \$4.64</p>
<p>Replaces Yazoo 204-019 and MTD 941-0524, 741-0524P. Used in many spindle shafts. Also fits Murray. Bearing No. 6203-2RS.</p>	<p>Flange Bearing. Replaces MTD 748-0110 &amp; 948-0110, bronze.</p>
 <p>ID 5/8" (15.88 mm) OD 1-3/8" (34.93 mm) Height 1/2" (11.11 mm)</p>	 <p>ID 5/8" (15.88 mm) OD 1-3/8" (34.93 mm) Height 7/16" (11.11 mm)</p>
<p><b>ORDER #:</b> 7950      <b>SUGG LIST:</b> \$15.50</p>	<p><b>ORDER #:</b> 8198      <b>SUGG LIST:</b> \$11.03</p>
<p>Front wheel bearing replaces Grasshopper 120050, John Deere PT8894, Snapper 7035358. Also fits Walker 5037, Dixie Chopper 10205. Bearing No. 44F40P.</p>	<p>High speed edger bearing. Replaces Bunton PLO 678, Scag 48224, Snapper 7077324, Exmark 303051, John Deere PT8891. Bearing No. 99502H-2RS.</p>
 <p>ID 5/8" (15.88 mm) OD 1-3/8" (34.93 mm) Height 7/16" (11.11 mm)</p>	 <p>ID 5/8" (15.88 mm) OD 1-3/8" (34.93 mm) Height 7/16" (11.11 mm)</p>
<p><b>ORDER #:</b> 8199      <b>SUGG LIST:</b> \$7.95</p>	<p><b>ORDER #:</b> 8831      <b>SUGG LIST:</b> \$12.93</p>
<p>High speed bearing, double sealed replaces Snapper 7010756 Dixie Chopper 67205, Bobcat 38046N, Scag 48224. Bearing No. 99502H-2RSNR.</p>	<p>Spindle bearing for Murray 92574 spindle assembly. Fits our 10-2925 Murray spindle assembly. Lower bearing.</p>
 <p>ID 5/8" (15.88 mm) OD 1-9/16" (39.69 mm) Height 15/32" (11.91 mm)</p>	 <p>ID 5/8" (15.88 mm) OD 1-3/8" (34.93 mm) Height 7/16" (11.11 mm)</p>
<p><b>ORDER #:</b> 8861      <b>SUGG LIST:</b> \$12.65</p>	<p><b>ORDER #:</b> 18199      <b>SUGG LIST:</b> \$7.59</p>
<p>Spindle bearing for Murray 92574 spindle assembly. Fits our 10-2925 Murray spindle assembly. Also used in 10-8320 spindle repair kit. Upper bearing.</p>	<p>High speed bearing. (carded)</p>

	ID 5/8" (15.9 mm) OD 1-3/8" (34.9 mm) Height 1" (25.4 mm)		ID 21/32" (17 mm) OD 1-9/16" (40 mm) Height 15/32" (12 mm)
<b>ORDER #:</b> 9338	<b>SUGG LIST:</b> \$8.65	<b>ORDER #:</b> 7210	<b>SUGG LIST:</b> \$11.85
5/8" universal roller cage bearing.		Spindle bearing replaces Toro/Wheel Horse 109966. Fits 42" & 48" decks. Bearing No. 6203-RS, sealed one side.	
	ID 21/32" (17 mm) OD 1-9/16" (40 mm) Height 15/32" (12 mm)		ID 21/32" (17 mm) OD 1-9/16" (40 mm) Height 15/32" (12 mm)
<b>ORDER #:</b> 7917	<b>SUGG LIST:</b> \$6.95	<b>ORDER #:</b> 8507	<b>SUGG LIST:</b> \$13.65
Bearing replaces Noma 49562 & Snapper 7026808. Used in 10-1172 quill assembly. Bearing No. 6203ZZ.		Bearing replaces AYP 110485X. Fits AYP 130794 quill assembly (top bearing). Also replaces Husky 532110485, MTD 741-0600. Bearing No. 6203-2RS.	
	ID 3/4" OD 1-3/4" Height 1/2"		ID 3/4" (19.05 mm) OD 1-3/8" (34.93 mm) Height 17/32" (13.49 mm)
<b>ORDER #:</b> 11835	<b>SUGG LIST:</b> \$18.95	<b>ORDER #:</b> 328	<b>SUGG LIST:</b> \$4.65
Flanged wheel bearing replaces Hustler 39677.		Sealed one side. Fits Snapper 7026693, 7011807. Also fits Wheel Horse 110513.	
	ID 3/4" (19.05 mm) OD 1-25/32" (45.24 mm) Height 19/32" (15.08 mm)		ID 3/4" (19.05 mm) OD 1-3/4" (44.45 mm) Height 1/2" (12.70 mm)
<b>ORDER #:</b> 484	<b>SUGG LIST:</b> \$10.50	<b>ORDER #:</b> 487	<b>SUGG LIST:</b> \$20.25
Spindle bearings for Snapper 7013313, Ariens 54073, Wheel Horse 109842, Simplicity 108202, . Used on our 10-7154 Shaft. Bearing No. 9504-ZZ.		Sealed high speed bearing. For Ariens 54063 Snowblowers. Bearing for LX172 John Deere. bearing No. SC0493LU.	

	<p>ID 3/4" (19.05 mm) OD 1-25/32" (45.24 mm) Height 21/32" (16.67 mm)</p>		<p>ID 3/4" (19.05 mm) OD 1-3/8" (34.93 mm) Height 1/2" (12.70 mm)</p>
<p><b>ORDER #:</b> 813</p>	<p><b>SUGG LIST:</b> \$9.95</p>	<p><b>ORDER #:</b> 6573</p>	<p><b>SUGG LIST:</b> \$14.85</p>
<p>Replaces Snapper 7012931, Ariens 54045; Bolens 1185275, JD 8188, Simplicity 154393, 154486, Toro 254-78. (economy) Bearing No. LM11949, LM11910.</p>		<p>Bearing replaces Snapper 7013680, 15474. Fits Driven Disc Assembly No. 57444 on self-propelled models. Heavy Duty - Removable back seal.</p>	
	<p>ID 3/4" (19.05 mm) OD 1-3/8" (34.93 mm) Height 1-1/8" (28.58 mm)</p>		<p>ID 3/4" (19.05 mm) OD 1-27/32" (46.83 mm) Height 27/32" (21.43 mm)</p>
<p><b>ORDER #:</b> 7869</p>	<p><b>SUGG LIST:</b> \$8.95</p>	<p><b>ORDER #:</b> 8863</p>	<p><b>SUGG LIST:</b> \$33.95</p>
<p>Heavy duty universal roller cage bearing.</p>		<p>Shaft bearing with locking collar &amp; set screw replaces Blue Bird 315. Used with our 15-6324 flail bld set, 10-8755 shaft set, &amp; 10-8741 spacer set.</p>	
	<p>ID 3/4" (19.05 mm) OD 1-25/32" (45.25mm)</p>		<p>ID .787" (20 mm) OD 1.85" (47 mm) Height 9/16" (14.29 mm)</p>
<p><b>ORDER #:</b> 9944</p>	<p><b>SUGG LIST:</b> \$25.74</p>	<p><b>ORDER #:</b> 442</p>	<p><b>SUGG LIST:</b> \$8.65</p>
<p>Wheel bearing kit for Exmark. Includes 2 09-813 bearings, 2 10-10013 seals, 2 08-10064 spacers. Used in our 08-9803, 08-9804 &amp; 08-9809 wheel assembly.</p>		<p>Replaces Ariens 54123, John Deere 7677R, MTD 741-0919, Toro 251-297, Simplicity 118011 Fits our quill assembly 17-8479. Bearing No. 6204-2RS.</p>	
	<p>ID .9845" (25.0mm) OD 2.0472" (52mm) Height 19/32" (15mm)</p>		<p>ID 63/64" (25 mm) OD 2-3/64" (52 mm) Height 19/32" (15.08 mm)</p>
<p><b>ORDER #:</b> 10303</p>	<p><b>SUGG LIST:</b> \$6.80</p>	<p><b>ORDER #:</b> 7162</p>	<p><b>SUGG LIST:</b> \$15.25</p>
<p>Spindle bearing replaces Grasshopper 833210. Sealed 1 side.</p>		<p>Bearing replaces Toro/Wheel Horse 113514, 50" &amp; 60" cut ZTR 500 series mowers. Fits Grasshopper 33210. Bearing No. 6205-RS, sealed one side.</p>	

	ID 63/64" (25.00 mm) OD 2-7/16" (61.91 mm) Height 21/32" (16.67 mm)		ID 63/64" (25.00 mm) OD 2-7/16" (62 mm) Height 21/32" (16.67 mm)
<b>ORDER #:</b> 3217	<b>SUGG LIST:</b> \$16.75	<b>ORDER #:</b> 7178	<b>SUGG LIST:</b> \$18.24
Sealed bearing. Replaces Bobcat 35008N, Bunton PL4611, PL4609, Exmark 1-303543, 1-303057, Snapper 19125, 76510, John Deere 9467. Bearing No. 6305-2RS.		Spindle bearing replaces Scag 48101-02. Used on our spindle 10-5722. Bearing No. 6305-Z, sealed one side.	
	ID 1" (25.40 mm) OD 2" (50.80 mm) Height 9/16" (14.29 mm)		ID 1" (25.40 mm) OD 2.0472" (52 mm) Height 27/32" (21.43 mm)
<b>ORDER #:</b> 6534	<b>SUGG LIST:</b> \$18.89	<b>ORDER #:</b> 8488	<b>SUGG LIST:</b> \$15.39
Wheel Bearing. Replaces Scag 48193-01 & 481858, Toro 251-299. Used on Scag midsize walk mowers.		Bearing replaces Dixon 1701 & 539115279. replaces Exmark 513016, John Deere 8597, Grasshopper 120081, Dixie Chopper 30218. Bearing No. RA100RR.	
	ID 1" (25.40 mm) OD 2" (50.8 mm) Height 1-3/4" (44.45 mm)		ID 1" (25.40 mm) OD 2.0475" (52 mm) Height .708" (18 mm)
<b>ORDER #:</b> 11060	<b>SUGG LIST:</b> \$57.63	<b>ORDER #:</b> 12119	<b>SUGG LIST:</b> \$28.97
Jackshaft spindle bearing replaces Exmark 1-513012. Includes locking collar and set screw.		Spindle bearing replaces Exmark 103-2477.	
	ID 1" (25.4mm) OD 2" (50.8mm) Height 7/8" (22.23mm)		ID 1-3/8" (34.93 mm) OD 5/8" (15.86 mm) Length 2-5/8" (66.68 mm)
<b>ORDER #:</b> 9937	<b>SUGG LIST:</b> \$8.49	<b>ORDER #:</b> 8996	<b>SUGG LIST:</b> \$11.72
Bearing replaces Dixie Chopper 30218.		Roller cage bearing only for Walker. Replaces Walker 5714-5. Used on our Walker wheel assembly 08-7982.	

		ID 1-1/2" (38.10 mm) OD 3/4" (19.05 mm)
<b>ORDER #:</b> 9002	<b>SUGG LIST:</b> \$12.50	
Roller cage bearing only for Toro. Replaces Toro 62-5570. Used on Toro 68-8970 front caster wheel assembly.		

*BUSHINGS - LISTED IN ORDER FROM ID SMALLEST TO LARGEST*

		ID 3/8" (9.53 mm) OD 1/2" (12.70 mm) Height 3/8" (9.53 mm) Flange OD 5/8" (15.88 mm)
<b>ORDER #:</b> 853	<b>SUGG LIST:</b> \$1.50	
Tie Rod Bushing Snapper 13321, nylon. M		

		ID 3/8" (9.53 mm) OD 17/32" (13.49 mm) Height 15/32" (11.91 mm) Flange OD 11/16" (17.46 mm)
<b>ORDER #:</b> 7279	<b>SUGG LIST:</b> \$2.46	
Draglink bushing for front engine riders. Replaces AYP 126847X.		

		ID 3/8" (9.53 mm) OD 5/8" (15.88 mm) Height 2-13/16" (71.44 mm) Flange OD 1" (25.40 mm)
<b>ORDER #:</b> 8586	<b>SUGG LIST:</b> \$12.36	
Wheel bushing replaces Exmark 61-03602. Fits in wheel 603299 on Exmark commercial mowers. Models Turf Ranger, Turf Tracer Explorer.		

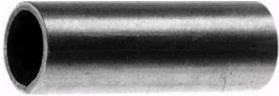





		ID 7/16" (11.13 mm) OD 9/16" (14.29 mm) Length 1-5/8" (41.28 mm)
<b>ORDER #:</b> 2907	<b>SUGG LIST:</b> \$2.25	
Replaces Snapper 7012309. Wheel Bushing for our 07-2991, 07-2992 & 07-855, 07-8927, 07-8927, 07-8928, 07-8929, 07-8931.		

	<p style="text-align: center;">ID 1/2" (12.70 mm) OD 5/8" (15.88 mm) Height 5/8" (15.88 mm) Flange OD 3/4" (19.05 mm)</p>		<p style="text-align: center;">ID 1/2" (12.70 mm) OD 3/4" (19.05 mm) Height 19/32" (15.08 mm) Flange OD</p>
<b>ORDER #:</b> 329	<b>SUGG LIST:</b> \$0.69	<b>ORDER #:</b> 382	<b>SUGG LIST:</b> \$3.96
Wheel Bushing, nylon.		Replaces MTD 748-0108 & 948-0108, bronze.	
	<p style="text-align: center;">ID 1/2" (12.70 mm) OD 3/4" (19.05 mm) Height 3/4" (19.05 mm) Flange OD 15/16" (23.81 mm)</p>		<p style="text-align: center;">ID 1/2" (12.70 mm) OD 7/8" (22.23 mm) Height 29/32" (23.02 mm)</p>
<b>ORDER #:</b> 3216	<b>SUGG LIST:</b> \$2.25	<b>ORDER #:</b> 6542	<b>SUGG LIST:</b> \$9.40
Replaces Air Cap / K&S T16276, 3999. Bronze bushing. Velke Sulky Wheel Bearing.		Sleeve and Bearing Assembly. Replaces Lawn-Boy 681904. Used on Lawn-Boy self propelled mowers.	
	<p style="text-align: center;">ID 1/2" (12.70mm) OD 1-1/8" (28.58mm) Height 1/4" (6.35mm)</p>		<p style="text-align: center;">ID 1/2" (12.70mm) OD 3/4" (19.05mm) Length 7-1/2" (190.50mm)</p>
<b>ORDER #:</b> 9502	<b>SUGG LIST:</b> \$1.75	<b>ORDER #:</b> 9992	<b>SUGG LIST:</b> \$10.00
Engine mount bushing replaces MTD 922-0153. Fits 600 series riders. Nylon.		Spacer replaces Exmark 1-633959 & Scag 43583. Fits Exmark Laser Z 13 x 650 x 6 wheels. Used with our 08-10075 wheel.	
	<p style="text-align: center;">ID 1/2" (12.70mm) OD 3/4" (19.05mm) Length 5-7/8" (149.22mm)</p>		<p style="text-align: center;">ID 5/8" OD 7/8" Height 1/4"</p>
<b>ORDER #:</b> 10017	<b>SUGG LIST:</b> \$7.67	<b>ORDER #:</b> 13229	<b>SUGG LIST:</b> \$2.80
Spacer replaces Exmark 1-633579, Scag 43581. Fits Exmark Laser Z 13 x 500 x 6 wheels. Used with our 08-9804 wheel.		Hex steering bushing replaces MTD 741-0656, 941-0656A.	

# BEARINGS & BUSHINGS

## Bushings



 <p>ID 5/8" (15.8mm) OD .900" (22.8mm) Height .870" (22.0mm)</p>	 <p>ID 5/8" (15.88 mm) OD 7/8" (22.23 mm) Length 1-11/16" (15.88 mm)</p>
<p><b>ORDER #:</b> 14557      <b>SUGG LIST:</b> \$4.46</p>	<p><b>ORDER #:</b> 2892      <b>SUGG LIST:</b> \$1.69</p>
<p>Steering shaft bushing replaces John Deere GX21994. Fits L100 series, Sabre &amp; Scotts models. Flange OD 1"</p>	<p>Bushing only for our 10-2925.</p>
 <p>ID 5/8" (15.88 mm) OD 1-1/8" (28.58 mm) Height 3/4" (19.05 mm) Flange OD</p>	 <p>ID 5/8" (15.88 mm) OD 11/16" (17.46 mm) Height 5/8" (15.88 mm) Flange OD 1" (22.40 mm)</p>
<p><b>ORDER #:</b> 2936      <b>SUGG LIST:</b> \$3.25</p>	<p><b>ORDER #:</b> 2939      <b>SUGG LIST:</b> \$1.65</p>
<p>Replaces Murray 24615. Also fits Roof front wheels. Graphite Impregnated.</p>	<p>Replaces Snapper 7010694. Steering Bushing (Bottom) nylon.</p>
 <p>ID 5/8" (15.88 mm) OD 3/4" (19.05 mm) Height 3/4" (19.05 mm) Flange OD 1-1/8" (28.58 mm)</p>	 <p>ID 5/8" (15.88 mm) OD 7/8" (22.23 mm) Height 5/8" (15.88 mm)</p>
<p><b>ORDER #:</b> 3201      <b>SUGG LIST:</b> \$4.49</p>	<p><b>ORDER #:</b> 3202      <b>SUGG LIST:</b> \$4.11</p>
<p>Flange Bearing. Replaces MTD 748-0184, bronze.</p>	<p>Flange Bearing. Replaces MTD 748-0227A, 748-0227 &amp; 948-0227A (Hex Nut), bronze.</p>
 <p>ID 5/8" (15.88 mm) OD 3/4" (19.05 mm) Height 3/4" (19.05 mm) Flange OD 1" (25.40 mm)</p>	 <p>ID 5/8" (15.8mm) OD 15/16" (23.8mm) Height 1" (25.4mm)</p>
<p><b>ORDER #:</b> 3213      <b>SUGG LIST:</b> \$5.77</p>	<p><b>ORDER #:</b> 13467      <b>SUGG LIST:</b> \$2.82</p>
<p>Replaces MTD 748-0867, Tecumseh 780105A. Fits 700, 800, &amp; 900 series transmissions 3 &amp; 5 speed output shaft. Oil impregnated, bronze.</p>	<p>Plastic flange bearing replaces MTD 741-0659. Flange OD 1-1/4".</p>

	ID 5/8" (15.88 mm) OD 13/16" (20.64 mm) Height 1" (25.40 mm)		ID 5/8" (15.88 mm) OD 7/8" (22.23 mm) Height 5/8" (15.88 mm)
<b>ORDER #:</b> 7720	<b>SUGG LIST:</b> \$3.97	<b>ORDER #:</b> 7836	<b>SUGG LIST:</b> \$3.79
Nylon wheel bushing. Replaces MTD 741-0487A & 941-0487A. Fits MTD rider models 530-568 and 600-658.		King pin nylon bushing replaces MTD 941-0225. Fits 38" and 42" cut front engine riders.	
	ID 5/8" (15.88 mm) OD 1-3/8" (34.93 mm) Height 45/64" (17.86 mm)		ID .635" OD .817" Length 1" Flange OD 1-1/4"
<b>ORDER #:</b> 9044	<b>SUGG LIST:</b> \$3.95	<b>ORDER #:</b> 12856	<b>SUGG LIST:</b> \$4.51
Flanged wheel bushing replaces Murray 56105. Fits Murray riders. Nylon		Wheel bushing replaces MTD 941-0706 & 741-0706, with grease fitting.	
	ID 43/64" (17.07 mm) OD 1-7/8" (47.63 mm) Height 3-3/4" (95.25 mm)		ID 3/4" (19.05 mm) OD 1-3/8" (34.93 mm) Height 5/8" (15.88 mm) Flange OD 1-1/2" (38.10 mm)
<b>ORDER #:</b> 9046	<b>SUGG LIST:</b> \$3.25	<b>ORDER #:</b> 339	<b>SUGG LIST:</b> \$3.95
Auger bushing replaces Noma 54837. Fits Noma snow throwers.		Replaces AMF 39979. Also fits many Sears. Graphite Impregnated.	
	ID 3/4" (19.05 mm) OD 13/16" (20.64 mm) Height 9/16" (14.29 mm) Flange OD 1-1/4" (31.75 mm)		ID 3/4" (19.05 mm) OD 1-1/8" (28.58 mm) Height 3/4" (19.05 mm) Flange OD 1-1/4" (31.75 mm)
<b>ORDER #:</b> 854	<b>SUGG LIST:</b> \$1.50	<b>ORDER #:</b> 2935	<b>SUGG LIST:</b> \$2.75
King Pin Bushing Snapper 10986, nylon.		Replaces Murray 403010 & Bobcat 148048-01. Graphite Impregnated. Also replaces Gilson 24829.	









 <p>ID 3/4" (19.05 mm) OD 1-1/4" (31.75 mm) Height 3/4" (19.05 mm) Flange OD 1-3/8" (34.93 mm)</p>	 <p>ID 3/4" (19.05 mm) OD 1" (25.40 mm) Height 3/4" (19.05 mm) Flange OD 1-1/4" (31.75 mm)</p>
<p><b>ORDER #:</b> 3200      <b>SUGG LIST:</b> \$6.02</p>	<p><b>ORDER #:</b> 3211      <b>SUGG LIST:</b> \$5.29</p>
<p>Replaces MTD 741-0199, nylon.</p>	<p>Replaces MTD 741-0293 &amp; 941-0293, nylon.</p>
 <p>ID 3/4" (19.05 mm) OD 1-3/8" (34.93 mm) Height 1" (25.40 mm)</p>	 <p>ID 3/4" (19.05 mm) OD 1" (25.40 mm) Height 1-15/16" (49.21 mm) Flange OD 1-1/8" (28.58 mm)</p>
<p><b>ORDER #:</b> 7258      <b>SUGG LIST:</b> \$3.95</p>	<p><b>ORDER #:</b> 3222      <b>SUGG LIST:</b> \$11.98</p>
<p>Front wheel bushing. Replaces Murray 91334 &amp; 491334. Used on 36", 38" and 40" front engine rider. (Plastic)</p>	<p>Flange Bearing. Replaces MTD 748-0169 &amp; 948-0169. Graphite Impregnated.</p>
 <p>ID 3/4" (19.05 mm) OD 1-3/8" (34.93 mm) Height 3/4" (19.05 mm) Flange OD 1-9/16" (39.69 mm)</p>	 <p>ID 3/4" (19.05 mm) OD 1" (25.40 mm) Height 5/8" (15.88 mm)</p>
<p><b>ORDER #:</b> 3305      <b>SUGG LIST:</b> \$3.75</p>	<p><b>ORDER #:</b> 8445      <b>SUGG LIST:</b> \$5.70</p>
<p>Replaces AMF 40195. Spindle Bearing. Graphite Impregnated.</p>	<p>Snowblower axle bushing replaces Ariens 55039 &amp; John Deere M127082. Fits older Ariens snowblowers model 1032. Oil impregnated, bronze.</p>
 <p>ID 3/4" (19.05 mm) OD 7/8" (22.23 mm) Height 21/32" (16.67 mm) Flange OD 1-3/16" (30.16 mm)</p>	 <p>ID 3/4" (19.05 mm) OD 1" (25.40 mm) Height 3/4" (19.05 mm) Flange OD 1-3/8" (34.93 mm)</p>
<p><b>ORDER #:</b> 8783      <b>SUGG LIST:</b> \$3.50</p>	<p><b>ORDER #:</b> 8306      <b>SUGG LIST:</b> \$2.29</p>
<p>Bushing replaces Ariens 55216. Fits newer snowblower models ST-524 &amp; ST-724. Oil impregnated, iron.</p>	<p>Spindle bearing replaces AMF/Dynamark 52407. Used on 39" cut, 12 hp, front engine rider models 3912-081 &amp; 082. Sintered Steel.</p>

	<p style="text-align: center;">ID 3/4" (19mm) OD .945" (24mm) Height 1" (25.4mm)</p>		<p style="text-align: center;">ID 3/4" (19.05mm) OD 1" (25.4mm) Height 1" (25.4mm)</p>
<b>ORDER #:</b> 13468	<b>SUGG LIST:</b> \$1.63	<b>ORDER #:</b> 9109	<b>SUGG LIST:</b> \$5.34
Plastic flange bearing replaces MTD 741-0660A.		Front wheel bushing replaces Stiga 1134-1875-01. Bronze.	
	<p style="text-align: center;">ID 3/4" (19.05mm) OD 1" (25.4mm) Height 1" (25.4mm)</p>		<p style="text-align: center;">ID 3/4" (19.05mm) OD 53/64" (21.83mm) Height 25/32" (19.84mm) Flange OD 1-1/8" (28.58mm)</p>
<b>ORDER #:</b> 9572	<b>SUGG LIST:</b> \$6.49	<b>ORDER #:</b> 9745	<b>SUGG LIST:</b> \$2.46
Bearing sleeve replaces MTD 741-0340, 941-0340. Fits 600 series models. Also fits 1985-1987 MTD rider models 135-137 with single speed transaxle only.		King pin bushing replaces AYP 121922x.	
	<p style="text-align: center;">ID 3/4" (19.05mm) OD 1-1/8" (28.58mm) Width 5/8" (15.88mm)</p>		<p style="text-align: center;">ID 3/4" OD 1" Height 1-3/8" Flange OD 1-1/16"</p>
<b>ORDER #:</b> 10064	<b>SUGG LIST:</b> \$1.84	<b>ORDER #:</b> 12857	<b>SUGG LIST:</b> \$5.58
Front wheel spacer replaces Exmark 1-633581 & Scag 43584. Fits our 08-9803, 08-9804 & 08-9809 wheels. Spacer for front wheel, bearing & seal.		Wheel bushing replaces MTD 741-0990A, with grease fitting.	
	<p style="text-align: center;">ID 3/4" OD 1-3/8" Height 1"</p>		<p style="text-align: center;">ID 49/64" (19.4 mm) OD 1" (25.4 mm) Height 1-13/64" (30.55 mm)</p>
<b>ORDER #:</b> 13359	<b>SUGG LIST:</b> \$3.95	<b>ORDER #:</b> 11714	<b>SUGG LIST:</b> \$3.42
Wheel bearing/bushing replaces AYP 9040H / 532009040.		Plastic flange bearing replaces MTD 741-0516B. Fits front wheels on the following models, 13A344700, 13AL795H004, 13AL771H004, 17AC2ACG004.	

# BEARINGS & BUSHINGS

## Bushings



 <p>ID 7/8" (22.23 mm) OD 1-3/8" (34.93 mm) Height 1" (25.40 mm)</p>	 <p>ID 29/32" (23.02 mm) OD 31/32" (24.61 mm) Height 5/8" (15.88 mm) Flange OD 1-1/4" (31.75 mm)</p>
<p><b>ORDER #:</b> 7716      <b>SUGG LIST:</b> \$3.25</p>	<p><b>ORDER #:</b> 2940      <b>SUGG LIST:</b> \$1.50</p>
<p>Front wheel bushing. Replaces Murray 93064. Fits 18 hp Murray lawn tractors. Nylon</p>	<p>Replaces Snapper 12617. Steering Bushing (Top) nylon.</p>
 <p>ID 1" (25.40 mm) OD 1-1/8" (28.58 mm) Height 5/8" (15.88 mm)</p>	 <p>ID 1" (25.40 mm) OD 1-3/8" (34.93 mm) Height 3/4" (19.05 mm) Flange OD 1-3/4" (44.45 mm)</p>
<p><b>ORDER #:</b> 8446      <b>SUGG LIST:</b> \$5.70</p>	<p><b>ORDER #:</b> 8522      <b>SUGG LIST:</b> \$3.17</p>
<p>Snowblower auger bushing replaces Ariens 55035 &amp; John Deere M124417. Fits all auger side bushings models 1960 to present. Oil impregnated, bronze.</p>	<p>Yoke bushing replaces Gravelly 18355. Yoke bushing on models Promaster, Pro 40, Pro 50, Pro 200, Pro 100, nylon.</p>
 <p>ID 1" (25.4 mm) OD 1-1/4" (31.7 mm) Height 19/32" (15.0 mm)</p>	 <p>ID 1" (25.4 mm) OD 1-3/8" (34.9 mm) Height 1-1/4" (31.75 mm)</p>
<p><b>ORDER #:</b> 9327      <b>SUGG LIST:</b> \$2.50</p>	<p><b>ORDER #:</b> 10240      <b>SUGG LIST:</b> \$7.19</p>
<p>King pin bushing replaces MTD 741-0374. Fits MTD model 406 rear tine tiller. Lower chain case bearing on tiller. Flanged OD 1-1/2". (nylon)</p>	<p>Pulley spacer replaces MTD 950-0957. Spacer for our 13-10185 &amp; 13-10186 engine pulleys.</p>
 <p>ID 1-1/8" (28.58 mm) OD 1-3/8" (34.93 mm) Height 1" (25.40 mm)</p>	 <p>ID 1-1/2" (38.10 mm) OD 3/4" (19.05 mm)</p>
<p><b>ORDER #:</b> 8476      <b>SUGG LIST:</b> \$7.72</p>	<p><b>ORDER #:</b> 8999      <b>SUGG LIST:</b> \$2.52</p>
<p>Yoke bushing replaces Toro 28-9290, Scag 48100-02. Fits Toro midsized mowers 36", 37", 44", 52", 62" cut. Deck models 30136, 30137, 30144, 30152.</p>	<p>Retainer bushing only for Exmark. Used on Exmark 1-3322154 wheel assembly &amp; our 08-8197 wheel assembly for Gravelly.</p>

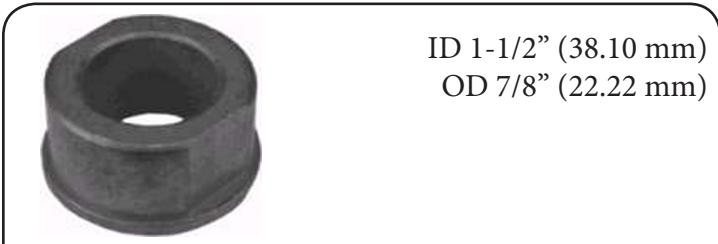

ID 1-1/2" (38.10 mm)  
OD 7/8" (22.22 mm)

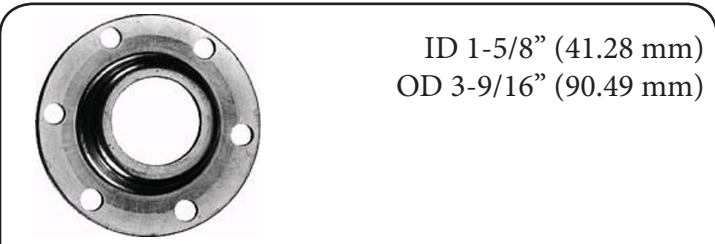

ID 1-5/8" (41.28 mm)  
OD 3-9/16" (90.49 mm)

**ORDER #:** 9011

**SUGG LIST:** \$3.49

**ORDER #:** 367

**SUGG LIST:** \$10.20

Retainer bushing only for Bobcat. Replaces Bobcat 38025N. Used on our 08-905 wheel assembly.

Bearing Housing. Replaces MTD 08253B.

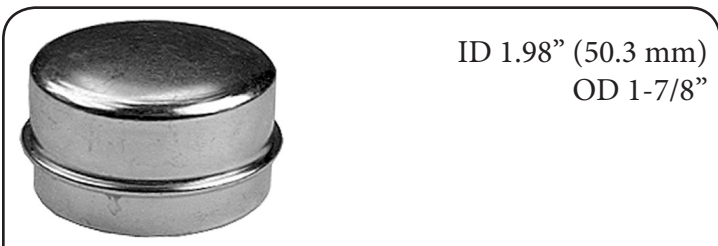

ID 1.98" (50.3 mm)  
OD 1-7/8"

**ORDER #:** 10665

**SUGG LIST:** \$3.15

Caster yoke grease cap replaces Scag 481559. Also fits Dixie Chopper 10220 dust cap for 1" ID bearings.

# Belts



## **BELTS** ..... 111

- » OEM Belts by Size ..... 112
- » Dimensional Belts..... 120
  - + 3/8" ..... 120
  - + 1/2" ..... 120
  - + 5/8" ..... 122
- » Belts by Application ..... 124
  - + Ariens ..... 124
  - + AYP..... 125
  - + Bobcat..... 132
  - + Bunton..... 133
  - + Comet..... 133
  - + Cub Cadet ..... 135
  - + Dixie Chopper..... 137
  - + Dixon ..... 140
  - + Exmark..... 140
  - + Ferris ..... 144
  - + Grasshopper ..... 145
  - + Gravely ..... 147
  - + Great Dane..... 147
  - + Hustler..... 148
  - + John Deere..... 151
  - + McClane ..... 154
  - + MTD..... 154
  - + Murray ..... 160
  - + Noma..... 163
  - + Scag ..... 164
  - + Simplicity ..... 167
  - + Snapper ..... 168
  - + Stihl ..... 169
  - + Toro ..... 169
  - + Troy Bilt..... 172
  - + Walker ..... 173
  - + Wright Stander ..... 174
  - + Yazoo/Kees ..... 174

*OEM BELTS BY SIZE*

Order Number	Length	Width	Sugg List	Order Number	Length	Width	Sugg List
8761	19.5" (494.92mm)	1/2" (12.70mm)	\$5.23	10833	31-3/4" (806.5mm)	5/8" (15.88mm)	\$11.37
10821	21-3/4" (552.45mm)	1/2" (12.70mm)	\$13.74	13118	31-57/64" (810.02mm)	9/16" (14.29mm)	\$21.15
869	22" (558.8mm)	3/8" (9.53mm)	\$6.50	13627	31-29/32" (810.42mm)	7/8" (22.23mm)	\$37.10
10822	22-1/4" (565.15mm)	1/2" (12.70mm)	\$12.82	13247	31-15/16" (811.21mm)	3/8" (9.53mm)	\$8.29
8887	23-59/64" (607.62mm)	1/2" (12.70mm)	\$10.99	12480	32" (812.8mm)	3/8" (9.53mm)	\$12.90
669	24-1/2" (622.30mm)	3/8" (9.53mm)	\$6.25	10306	32-3/16" (817.56mm)	3/8" (9.53mm)	\$10.75
8780	24-1/2" (622.30mm)	1/2" (12.70mm)	\$8.98	13052	32-13/64" (817.96mm)	3/4" (19.05mm)	\$27.55
11677	24-1/2" (622.30mm)	3/8" (9.53mm)	\$13.95	9848	32-1/2" (825.50mm)	3/8" (9.53mm)	\$10.75
670	25" (635mm)	3/8" (9.53mm)	\$6.50	13592	32-29/32" (835.82mm)	7/8" (22.23mm)	\$37.10
10256	25" (635mm)	45/64" (17.86mm)	\$13.12	8429	33" (838.2mm)	3/8" (9.53mm)	\$12.75
13567	27" (685.8mm)	3/8" (9.53mm)	\$11.96	7952	33" (838.2mm)	3/32" (2.38mm)	\$18.56
13284	27" (685.8mm)	1/4" (6.35mm)	\$29.20	13088	33-3/16" (842.9498mm)	3/4" (19.05mm)	\$27.55
8762	27-1/8" (688.98mm)	1/4" (6.35mm)	\$28.95	13059	33-25/32" (858.04mm)	3/4" (19.05mm)	\$27.55
13048	27-23/64" (694.93mm)	3/4" (19.05mm)	\$27.55	14215	33-13/16" (858.84mm)	5/8" (15.88mm)	\$19.79
8487	27-3/8" (695.33mm)	3/4" (19.05mm)	\$24.15	13057	33-7/8" (860.43mm)	7/8" (22.23mm)	\$37.10
13241	27-13/32" (696.12mm)	5/8" (15.88mm)	\$27.55	14718	33-7/8" (860.43mm)	5 Rib	\$17.30
4999	27-1/2" (698.50mm)	1/2" (12.70mm)	\$7.70	11030	34" (863.6mm)	25/32" (19.84mm)	\$16.95
8819	28" (711.2mm)	3/8" (9.53mm)	\$9.49	8430	34" (863.6mm)	3/8" (9.53mm)	\$19.95
13053	28-21/64" (719.53mm)	3/4" (19.05mm)	\$27.55	9861	34" (863.6mm)	9/16" (14.29mm)	\$16.01
10321	28-17/32" (724.69mm)	9/16" (14.29mm)	\$31.35	13288	34-13/32" (873.92mm)	3/8" (9.53mm)	\$19.98
14447	29" (736.6mm)	3/8" (9.53mm)	\$16.64	8425	34-1/2" (876.30mm)	1/2" (12.70mm)	\$15.70
9346	29-1/16" (738.19mm)	11/16" (17.46mm)	\$37.80	10090	34-1/2" (876.30mm)	3/8" (9.53mm)	\$28.05
12687	29-7/32" (742.16mm)	3/8" (9.53mm)	\$12.75	12462	34-37/64" (878.28mm)	11/16" (17.46mm)	\$34.95
10052	29-9/32" (743.74mm)	3/4" (19.05mm)	\$24.15	14228	34-33/50" (880.364mm)	6 Rib	\$17.75
13054	29-9/32" (743.74mm)	3/4" (19.05mm)	\$27.55	10486	34-3/4" (882.65mm)	3/8" (9.53mm)	\$8.93
11029	29-11/32" (745.33mm)	25/32" (19.84mm)	\$15.95	13509	34-7/8" (885.83mm)	1/2" (12.70mm)	\$19.45
9792	29-3/8" (746.13mm)	11/16" (17.46mm)	\$32.80	14118	35" (889mm)	1/2" (12.70mm)	\$14.32
14513	29-7/16" (747.71mm)	1/2" (12.70mm)	\$18.90	10089	35" (889mm)	1/2" (12.70mm)	\$17.98
6950	30" (762mm)	3/8" (9.53mm)	\$17.25	12429	35" (889mm)	3/8" (9.53mm)	\$27.95
10210	30" (762mm)	1/2" (12.70mm)	\$12.69	14042	35" (889mm)	3/8" (9.53mm)	\$19.39
7245	30-3/16" (766.76mm)	1/2" (12.70mm)	\$13.25	13058	35-9/64" (892.57mm)	3/4" (19.05mm)	\$27.55
13047	30-1/4" (768.35mm)	3/4" (19.05mm)	\$27.55	6906	35-1/4" (895.35mm)	5/8" (15.88mm)	\$27.25
13243	30-1/4" (768.35mm)	3/4" (19.05mm)	\$37.10	10042	35-3/8" (898.53mm)	3/4" (19.05mm)	\$25.30
13050	31-15/64" (793.35mm)	3/4" (19.05mm)	\$27.55	13505	35-13/32" (899.32mm)	1/2" (12.70mm)	\$18.95
13242	31-15/64" (793.35mm)	3/4" (19.05mm)	\$27.55	8432	35-1/2" (901.70mm)	3/8" (9.53mm)	\$15.95
11137	31-1/4" (793.75mm)	3/8" (9.53mm)	\$9.54	8820	35-1/2" (901.70mm)	3/8" (9.53mm)	\$17.37
14237	31-1/2" (800.10mm)	7/8" (22.23mm)	\$32.66	5242	35-39/64" (904.48mm)	5/8" (15.88mm)	\$14.49
13117	31-1/2" (800.10mm)	7/16" (11.11mm)	\$46.83	13232	35-5/8" (904.88mm)	3/8" (9.53mm)	\$11.21
13653	31-11/16" (804.86mm)	3/8" (9.53mm)	\$15.48	8733	36" (914.4mm)	1/2" (12.70mm)	\$14.25

### OEM BELTS BY SIZE

Order Number	Length	Width	Sugg List	Order Number	Length	Width	Sugg List
8426	36" (914.4mm)	3/8" (9.53mm)	\$16.95	10024	42-13/16" (1087.44mm)	21/32" (16.67mm)	\$23.34
12405	36-5/64" (916.38mm)	5/8" (15.88mm)	\$24.07	10317	43" (1092.2mm)	5/8" (15.88mm)	\$28.27
8811	36-1/8" (917.58mm)	1/2" (12.70mm)	\$12.02	12249	43-3/4" (1111.25mm)	5/8" (15.88mm)	\$32.13
9480	36-1/4" (920.75mm)	5/8" (15.88mm)	\$20.77	10025	43-13/16" (1112.84mm)	21/32" (16.67mm)	\$20.19
8747	36-25/32" (934.24mm)	1/4" (6.35mm)	\$8.95	10832	43-7/8" (1114.43mm)	1/2" (12.70mm)	\$12.50
8428	37" (939.8mm)	1/2" (12.70mm)	\$24.95	5233	44" (1117.6mm)	5/8" (15.88mm)	\$25.55
13508	37-7/64" (942.58mm)	1/2" (12.70mm)	\$25.30	5241	44-1/8" (1120.78mm)	5/8" (15.88mm)	\$24.74
12246	37-1/2" (952.50mm)	3/8" (9.53mm)	\$17.97	6840	44-7/32" (1123.16mm)	5/8" (15.88mm)	\$24.36
13506	37-37/64" (954.48mm)	1/2" (12.70mm)	\$21.95	6836	44-45/64" (1135.46mm)	1-1/8" (28.58mm)	\$45.95
8760	37-5/8" (955.68mm)	1/2" (12.70mm)	\$26.30	10913	44-25/32" (1137.44mm)	25/32" (19.84mm)	\$19.95
10901	37-5/8" (955.68mm)	1/2" (12.70mm)	\$45.44	10026	44-13/16" (1138.24mm)	21/32" (16.67mm)	\$15.40
11811	37-3/4" (958.85mm)	3/8" (9.53mm)	\$14.66	5865	44-7/8" (1139.83mm)	5/8" (15.88mm)	\$23.57
10167	37-3/4" (958.85mm)	1/2" (12.70mm)	\$16.18	10911	45" (1143mm)	7/16" (11.11mm)	\$15.95
14117	37-3/4" (958.85mm)	5/8" (15.88mm)	\$30.12	9932	45" (1143mm)	5/8" (15.88mm)	\$22.59
13507	37-63/64" (964.80mm)	1/2" (12.70mm)	\$29.85	14571	46" (1168.4mm)	1/2" (12.70mm)	\$13.05
13254	38" (965.2mm)	5/8" (15.88mm)	\$18.16	8717	46-5/8" (1184.28mm)	1/2" (12.70mm)	\$39.95
14116	38" (965.2mm)	5/8" (15.88mm)	\$30.12	13573	46-15/16" (1192.21mm)	1/2" (12.70mm)	\$29.47
10320	38" (965.2mm)	1-1/4" (31.75mm)	\$45.45	12239	47" (1193.8mm)	21/32" (16.67mm)	\$17.71
11135	38-5/32" (969.17mm)	3/8" (9.53mm)	\$10.88	10322	47" (1193.8mm)	9/16" (14.29mm)	\$35.20
6907	38-3/16" (969.96mm)	5/8" (15.88mm)	\$24.39	8798	47-1/16" (1195.39mm)	1/2" (12.70mm)	\$16.19
14120	38-3/8" (974.73mm)	1/2" (12.70mm)	\$16.30	8444	47-1/10" (1196.34mm)	1/2" (12.70mm)	\$12.10
10039	38-1/2" (977.90mm)	1/2" (12.70mm)	\$17.90	12688	47-3/8" (1203.33mm)	1/2" (12.70mm)	\$16.50
14512	38-31/32" (989.81mm)	5/8" (15.88mm)	\$31.20	5820	47-1/2" (1206.50mm)	1/2" (12.70mm)	\$20.43
9901	39" (990.6mm)	3/8" (9.53mm)	\$18.20	6908	48" (1219.2mm)	5/8" (15.88mm)	\$26.35
8427	39" (990.6mm)	1/2" (12.70mm)	\$18.30	9257	48-13/16" (1239.84mm)	1-1/8" (28.58mm)	\$62.71
10485	39-1/16" (992.19mm)	3/8" (9.53mm)	\$8.25	13108	48-53/64" (1240.23mm)	5/8" (15.88mm)	\$35.82
11132	39-1/4" (996.95mm)	3/8" (9.53mm)	\$12.71	5237	49-7/8" (1266.83mm)	1/2" (12.70mm)	\$15.16
10746	39-5/16" (998.54mm)	1-1/4" (31.75mm)	\$24.97	9482	50" (1270mm)	7/8" (22.23mm)	\$32.49
10717	39-13/32" (1000.92mm)	1/2" (12.70mm)	\$15.92	12069	50" (1270mm)	43/64" (17.07mm)	\$33.87
8812	39-5/8" (1006.48mm)	1/2" (12.70mm)	\$16.78	10047	50" (1270mm)	21/32" (16.67mm)	\$35.46
7791	39-13/16" (1011.24mm)	1/2" (12.70mm)	\$20.57	12693	50-1/8" (1273.18mm)	1/2" (12.70mm)	\$16.79
5238	39-7/8" (1012.83mm)	5/8" (15.88mm)	\$19.80	5231	50-3/8" (1279.53mm)	1/2" (12.70mm)	\$59.98
8431	40" (1016mm)	1/2" (12.70mm)	\$16.95	11027	50-25/64" (1279.92mm)	1" (25.4mm)	\$29.52
10716	40-13/32" (1026.32mm)	1/2" (12.70mm)	\$17.34	10887	50-1/2" (1282.70mm)	1/2" (12.70mm)	\$18.43
10323	40-7/16" (1027.11mm)	1-1/4" (31.75mm)	\$48.20	11028	50-1/2" (1282.70mm)	5/8" (15.88mm)	\$26.52
10023	40-29/32" (1039.02mm)	21/32" (16.67mm)	\$12.19	12049	50-1/2" (1282.70mm)	1/2" (12.70mm)	\$37.52
9769	41-1/2" (1054.10mm)	1/2" (12.70mm)	\$16.13	14939	50-3/4" (1289.05mm)	1/2" (12.70mm)	\$14.10
11483	41-1/2" (1054.10mm)	5/8" (15.88mm)	\$21.80	12850	51-13/64" (1300.56mm)	1/2" (12.70mm)	\$36.95
13157	42-1/4" (1073.15mm)	1/2" (12.70mm)	\$27.21	10253	51-3/8" (1304.93mm)	1/2" (12.70mm)	\$16.50

*OEM BELTS BY SIZE*

Order Number	Length	Width	Sugg List	Order Number	Length	Width	Sugg List
13551	51-3/4" (1314.45mm)	1/2" (12.70mm)	\$41.73	10043	60-55/64" (1545.83mm)	1/2" (12.70mm)	\$24.21
8092	51-29/32" (1318.42mm)	5/8" (15.88mm)	\$22.84	10319	61-5/8" (1565.28mm)	1/2" (12.70mm)	\$19.87
9713	52" (1320.8mm)	1/2" (12.70mm)	\$12.50	10782	62" (1574.8mm)	1/2" (12.70mm)	\$28.58
9765	52" (1320.8mm)	1/2" (12.70mm)	\$17.45	6504	62-1/10" (1577.34mm)	1/2" (12.70mm)	\$24.95
10045	52" (1320.8mm)	1/2" (12.70mm)	\$20.81	10844	62-1/4" (1581.15mm)	1/2" (12.70mm)	\$19.31
10252	52-1/4" (1327.15mm)	1/2" (12.70mm)	\$22.43	14129	62-1/2" (1587.50mm)	1/2" (12.70mm)	\$22.19
13408	52-1/4" (1327.15mm)	1/2" (12.70mm)	\$36.45	12413	63" (1600.2mm)	1/2" (12.70mm)	\$16.75
5235	52-3/8" (1330.33mm)	1-1/8" (28.58mm)	\$75.68	8808	63" (1600.2mm)	1/2" (12.70mm)	\$19.45
8711	52-13/16" (1341.44mm)	1/2" (12.70mm)	\$35.95	10781	63" (1600.2mm)	1" (25.4mm)	\$23.61
7789	52-29/32" (1343.82mm)	5/8" (15.88mm)	\$32.31	12414	64" (1625.6mm)	1/2" (12.70mm)	\$17.00
6839	53" (1346.2mm)	5/8" (15.88mm)	\$27.27	8731	64" (1625.6mm)	5/8" (15.88mm)	\$33.50
14564	53" (1346.2mm)	1/2" (12.70mm)	\$30.10	6844	64" (1625.6mm)	5/8" (15.88mm)	\$34.65
9570	53-1/4" (1352.55mm)	7/8" (22.23mm)	\$36.85	14537	64" (1625.6mm)	1/2" (12.70mm)	\$20.56
14562	53-1/4" (1352.55mm)	5/8" (15.88mm)	\$37.49	10388	64-1/4" (1631.95mm)	9/16" (14.29mm)	\$24.86
6507	53-11/16" (1363.66mm)	1/2" (12.70mm)	\$18.50	14565	64-5/16" (1633.54mm)	5/8" (15.88mm)	\$42.40
8810	54" (1371.6mm)	1/2" (12.70mm)	\$50.50	13366	64-1/2" (1638.30mm)	1/2" (12.70mm)	\$19.19
12070	54-1/2" (1384.30mm)	43/64" (17.07mm)	\$36.78	12078	64-1/2" (1638.30mm)	5/8" (15.88mm)	\$36.82
6876	54-15/16" (1395.41mm)	1/2" (12.70mm)	\$17.05	14765	64-19/25" (1644.904mm)	1/2" (12.70mm)	\$65.30
10049	55" (1397mm)	21/32" (16.67mm)	\$37.99	12067	65" (1651mm)	43/64" (17.07mm)	\$55.16
6969	55-31/32" (1421.61mm)	1/2" (12.70mm)	\$50.40	12695	65-3/32" (1653.38mm)	5/8" (15.88mm)	\$26.50
10402	57" (1447.8mm)	17/32" (13.49mm)	\$41.99	5821	65-1/2" (1663.70mm)	1/2" (12.70mm)	\$22.42
12916	57-3/16" (1452.56mm)	11/16" (17.46mm)	\$27.80	12068	65-5/8" (1666.88mm)	43/64" (17.07mm)	\$51.22
9863	57-13/64" (1452.96mm)	5/8" (15.88mm)	\$18.98	10743	65-3/4" (1670.05mm)	5/8" (15.88mm)	\$29.40
14566	57-3/8" (1457.325mm)	5/8" (15.88mm)	\$39.40	12694	66-3/8" (1685.93mm)	1/2" (12.70mm)	\$19.25
10848	57-3/8" (1457.33mm)	1/2" (12.70mm)	\$15.76	11503	66-29/32" (1699.42mm)	21/32" (16.67mm)	\$19.68
13477	57-15/32" (1459.71mm)	5/8" (15.88mm)	\$27.80	10784	67" (1701.8mm)	1/2" (12.70mm)	\$27.49
12382	57-45/64" (1465.66mm)	1/2" (12.70mm)	\$24.83	10369	67" (1701.8mm)	1" (25.4mm)	\$31.80
10257	58" (1473.2mm)	3/4" (19.05mm)	\$18.34	6949	67" (1701.8mm)	1/2" (12.70mm)	\$34.42
10884	58" (1473.2mm)	1/2" (12.70mm)	\$20.00	10100	67" (1701.8mm)	5/8" (15.88mm)	\$37.47
14810	58" (1473.2mm)	1/2" (12.70mm)	\$17.96	14026	67-6/25" (1707.9mm)	1/2" (12.70mm)	\$17.78
10914	59" (1498.6mm)	1/2" (12.70mm)	\$26.59	10912	67-1/2" (1714.50mm)	11/16" (17.46mm)	\$20.95
11223	59-29/32" (1521.62mm)	5/8" (15.88mm)	\$26.20	8809	67-3/4" (1720.85mm)	21/32" (16.67mm)	\$25.22
10949	59-15/16" (1522.41mm)	1/2" (12.70mm)	\$26.17	673	68" (1727.20mm)	AA	\$13.95
10783	60" (1524mm)	1/2" (12.70mm)	\$23.80	11840	68-1/4" (1733.55mm)	5/8" (15.88mm)	\$50.87
10050	60" (1524mm)	1/2" (12.70mm)	\$29.08	10893	68-1/2" (1739.90mm)	1/2" (12.70mm)	\$25.31
9119	60" (1524mm)	5/8" (15.88mm)	\$34.92	12799	68-51/64" (1747.44mm)	45/64" (17.86mm)	\$24.60
11019	60-1/16" (1525.59mm)	1/2" (12.70mm)	\$30.89	8512	69" (1752.6mm)	1/2" (12.70mm)	\$17.10
10563	60-1/2" (1536.70mm)	1/2" (12.70mm)	\$19.78	10831	69-3/16" (1757.36mm)	5/8" (15.88mm)	\$20.40
12094	60-1/2" (1536.70mm)	5/8" (15.88mm)	\$28.20	6842	69-9/32" (1759.74mm)	5/8" (15.88mm)	\$34.29

### OEM BELTS BY SIZE

Order Number	Length	Width	Sugg List	Order Number	Length	Width	Sugg List
14037	69-4/11" (1761.85mm)	5/8" (15.88mm)	\$23.26	7894	80-1/8" (2035.18mm)	1/2" (12.70mm)	\$42.25
8510	69-1/2" (1765.30mm)	1/2" (12.70mm)	\$23.60	8443	80-5/16" (2039.94mm)	1/2" (12.70mm)	\$26.50
12689	70-1/2" (1790.70mm)	1/2" (12.70mm)	\$21.95	13257	80-49/64" (2051.45mm)	1/2" (12.70mm)	\$34.48
11026	70-5/8" (1793.88mm)	1/2" (12.70mm)	\$33.50	10027	80-29/32" (2055.02mm)	21/32" (16.67mm)	\$35.27
10255	70-3/4" (1797.05mm)	17/32" (13.49mm)	\$29.85	13110	80-61/64" (2056.21mm)	5/8" (15.88mm)	\$38.85
13992	70-9/10 (1800.86mm)	3/8" (9.53mm)	\$12.75	9336	81-1/16" (2058.99mm)	1/2" (12.70mm)	\$30.12
14595	70-9/10 (1800.86mm)	5/8" (15.88mm)	\$26.10	10885	81-1/4" (2063.75mm)	5/8" (15.88mm)	\$29.71
6972	71" (1803.4mm)	5/8" (15.88mm)	\$41.54	10830	81-1/2" (2070.10mm)	1/2" (12.70mm)	\$42.22
14359	72" (1828.8mm)	1/2" (12.70mm)	\$47.36	9481	81-3/4" (2076.45mm)	1/2" (12.70mm)	\$17.95
675	73" (1854.2mm)	0	\$16.95	6896	82" (2082.8mm)	1/2" (12.70mm)	\$15.25
7838	73" (1854.2mm)	AA	\$16.95	6970	82" (2082.8mm)	1/2" (12.70mm)	\$21.07
10851	73-3/4" (1873.25mm)	1/2" (12.70mm)	\$24.24	5236	82" (2082.8mm)	5/8" (15.88mm)	\$30.25
6872	73-3/4" (1873.25mm)	5/8" (15.88mm)	\$33.33	10008	82" (2082.8mm)	1/2" (12.70mm)	\$32.61
9483	73-3/4" (1873.25mm)	AA	\$27.95	4998	82-3/32" (2085.18mm)	1/2" (12.70mm)	\$22.95
6841	74" (1879.6mm)	1/2" (12.70mm)	\$21.14	10624	82-1/4" (2089.15mm)	5/8" (15.88mm)	\$44.14
6845	74" (1879.6mm)	5/8" (15.88mm)	\$49.33	8091	82-11/32" (2091.53mm)	5/8" (15.88mm)	\$36.85
8767	75-1/8" (1908.18mm)	5/8" (15.88mm)	\$39.95	8464	82-1/2" (2095.50mm)	1/2" (12.70mm)	\$26.88
14731	75-3/8" (1914.53mm)	1/2" (12.70mm)	\$35.07	10078	82-1/2" (2095.50mm)	1/2" (12.70mm)	\$36.74
14319	75-3/8" (1914.53mm)	1/2" (12.70mm)	\$31.16	13109	82-39/64" (2098.28mm)	5/8" (15.88mm)	\$39.75
12426	75-25/64" (1914.92mm)	1/2" (12.70mm)	\$22.43	10029	82-29/32" (2105.82mm)	21/32" (16.67mm)	\$29.98
10628	76" (1930.4mm)	1/2" (12.70mm)	\$25.10	9935	83" (2108.2mm)	5/8" (15.88mm)	\$27.04
9847	76" (1930.4mm)	1/2" (12.70mm)	\$35.98	11129	83" (2108.2mm)	1/2" (12.70mm)	\$46.77
10623	77-1/2" (1968.50mm)	5/8" (15.88mm)	\$42.35	6509	83-1/10" (2110.74mm)	1/2" (12.70mm)	\$24.50
7672	77-11/16" (1973.26mm)	1/2" (12.70mm)	\$24.95	12708	83-13/32" (2118.52mm)	1/2" (12.70mm)	\$38.35
7128	77-3/4" (1974.85mm)	5/8" (15.88mm)	\$30.75	9368	83-1/2" (2120.90mm)	1/2" (12.70mm)	\$39.70
11846	77-3/4" (1974.85mm)	1/2" (12.70mm)	\$32.71	9367	83-1/2" (2120.90mm)	1/2" (12.70mm)	\$41.96
8509	78" (1981.2mm)	5/8" (15.88mm)	\$32.71	9312	83-5/8" (2124.08mm)	1/2" (12.70mm)	\$46.77
8463	78-1/2" (1993.90mm)	1/2" (12.70mm)	\$17.21	14638	83-3/4" (2127.25mm)	5/8" (15.88mm)	\$30.41
9903	78-1/2" (1993.90mm)	1/2" (12.70mm)	\$34.53	9337	83-3/4" (2127.25mm)	1/2" (12.70mm)	\$33.16
9767	79" (2006.6mm)	1/2" (12.70mm)	\$40.19	10030	83-13/16" (2128.84mm)	21/32" (16.67mm)	\$26.46
6843	79-3/32" (2008.98mm)	1/2" (12.70mm)	\$26.90	9712	84" (2133.6mm)	1/2" (12.70mm)	\$18.50
6901	79-7/64" (2009.38mm)	1/2" (12.70mm)	\$21.51	13301	84-7/64" (2136.38mm)	1/2" (12.70mm)	\$25.44
11849	79-1/4" (2012.95mm)	1/2" (12.70mm)	\$30.20	14567	84-5/16" (2141.54mm)	5/8" (15.88mm)	\$53.00
12770	79-19/64" (2014.14mm)	1/2" (12.70mm)	\$23.37	9964	84-1/2" (2146.30mm)	1/2" (12.70mm)	\$32.28
12248	79-1/2" (2019.3mm)	1/2" (12.70mm)	\$36.99	8781	84-1/2" (2146.30mm)	1/2" (12.70mm)	\$46.26
10318	79-13/16" (2027.24mm)	1/2" (12.70mm)	\$37.81	10031	84-13/16" (2154.24mm)	21/32" (16.67mm)	\$42.98
6871	80" (2032mm)	5/8" (15.88mm)	\$36.69	6838	85-7/32" (2164.56mm)	1/2" (12.70mm)	\$30.53
6900	80" (2032mm)	1/2" (12.70mm)	\$29.07	8803	85-3/10" (2166.62mm)	21/32" (16.67mm)	\$24.23
12085	80" (2032mm)	5/8" (15.88mm)	\$65.07	9698	85-3/8" (2168.53mm)	5/8" (15.88mm)	\$38.73

*OEM BELTS BY SIZE*

Order Number	Length	Width	Sugg List	Order Number	Length	Width	Sugg List
13541	85-3/8" (2168.53mm)	1/2" (12.70mm)	\$45.65	10035	91-5/16" (2319.34mm)	1/2" (12.70mm)	\$31.21
6904	85-15/16" (2182.81mm)	1/2" (12.70mm)	\$24.95	12489	91-13/32" (2321.72mm)	1/2" (12.70mm)	\$25.43
7631	86" (2184.4mm)	5/8" (15.88mm)	\$35.92	10435	91-13/16" (2332.04mm)	17/32" (13.49mm)	\$38.71
9994	86-1/4" (2190.75mm)	1/2" (12.70mm)	\$19.75	13035	91-7/8" (2333.63mm)	1/2" (12.70mm)	\$31.64
12417	86-19/64" (2191.94mm)	5/8" (15.88mm)	\$25.08	8511	92-1/2" (2349.50mm)	1/2" (12.70mm)	\$21.51
12898	86-25/64" (2194.32mm)	1/2" (12.70mm)	\$27.48	5823	93" (2362.2mm)	5/8" (15.88mm)	\$38.05
10814	86-29/32" (2207.42mm)	5/8" (15.88mm)	\$35.47	9945	93-1/2" (2374.9mm)	1/2" (12.70mm)	\$21.76
9313	87" (2209.8mm)	1/2" (12.70mm)	\$21.75	8370	94" (2387.6mm)	5/8" (15.88mm)	\$58.00
11130	87" (2209.8mm)	1/2" (12.70mm)	\$47.33	14801	94-9/20" (2399.03mm)	1/2" (12.70mm)	\$42.80
14365	87-1/2" (2222.50mm)	1/2" (12.70mm)	\$27.57	11225	94-29/32" (2410.62mm)	5/8" (15.88mm)	\$38.82
12892	87-41/64" (2226.07mm)	1/2" (12.70mm)	\$48.47	6508	95" (2413mm)	1/2" (12.70mm)	\$20.95
10032	87-13/16" (2230.44mm)	21/32" (16.67mm)	\$29.49	9764	95" (2413mm)	1/2" (12.70mm)	\$26.24
8805	87-15/16" (2233.61mm)	5/8" (15.88mm)	\$52.32	9768	95" (2413mm)	1/2" (12.70mm)	\$39.92
7184	88" (2235.2mm)	1/2" (12.70mm)	\$23.95	8784	95-1/4" (2419.35mm)	1/2" (12.70mm)	\$26.24
14563	88" (2235.2mm)	5/8" (15.88mm)	\$51.77	9697	95-1/2" (2425.70mm)	1/2" (12.70mm)	\$24.95
9715	88-1/4" (2241.55mm)	1/2" (12.70mm)	\$21.95	12398	95-11/16" (2430.46mm)	1/2" (12.70mm)	\$36.58
6502	88-5/16" (2243.14mm)	1/2" (12.70mm)	\$29.95	14572	95-3/4" (2432.05mm)	5/8" (15.88mm)	\$33.60
8516	88-3/8" (2244.73mm)	1/2" (12.70mm)	\$37.11	10749	95-3/4" (2432.05mm)	1/2" (12.70mm)	\$37.82
10434	88-5/8" (2251.08mm)	17/32" (13.49mm)	\$21.63	13501	96-13/32" (2448.72mm)	1/2" (12.70mm)	\$37.25
10625	88-3/4" (2254.25mm)	5/8" (15.88mm)	\$49.45	11660	96-1/2" (2451.10mm)	1/2" (12.70mm)	\$33.63
5867	88-4/5" (2255.52mm)	5/8" (15.88mm)	\$45.61	12052	96-7/8" (2460.63mm)	1/2" (12.70mm)	\$32.81
10910	89" (2260.6mm)	1/2" (12.70mm)	\$18.95	11226	96-29/32" (2461.42mm)	5/8" (15.88mm)	\$31.77
12751	89" (2260.6mm)	5/8" (15.88mm)	\$29.72	9995	97" (2463.8mm)	1/2" (12.70mm)	\$16.15
10077	89" (2260.6mm)	5/8" (15.88mm)	\$41.99	13036	97" (2463.8mm)	1/2" (12.70mm)	\$34.68
12873	89-1/4" (2266.95mm)	1/2" (12.70mm)	\$32.93	14569	97" (2463.8mm)	5/8" (15.88mm)	\$35.17
8972	89-1/2" (2273.30mm)	1/2" (12.70mm)	\$19.95	10009	97" (2463.8mm)	5/8" (15.88mm)	\$54.55
7790	89-39/64" (2276.08mm)	5/8" (15.88mm)	\$45.36	11862	97-13/32" (2474.12mm)	1/2" (12.70mm)	\$32.81
14382	89-4/5" (2280.92mm)	5/8" (15.88mm)	\$45.16	10232	97-13/32" (2474.12mm)	21/32" (16.67mm)	\$42.84
9581	89-29/32" (2283.62mm)	5/8" (15.88mm)	\$55.80	11017	97-2/3" (2480.73mm)	5/8" (15.88mm)	\$35.40
6898	90" (2286mm)	1/2" (12.70mm)	\$17.78	8462	98-1/4" (2495.55mm)	1/2" (12.70mm)	\$28.39
6902	90" (2286mm)	1/2" (12.70mm)	\$22.59	8465	99" (2514.6mm)	1/2" (12.70mm)	\$19.37
10076	90" (2286mm)	5/8" (15.88mm)	\$43.05	9120	99" (2514.6mm)	1/2" (12.70mm)	\$33.79
11861	90-1/4" (2292.35mm)	1/2" (12.70mm)	\$26.89	6903	99" (2514.6mm)	1/2" (12.70mm)	\$41.95
11848	90-1/4" (2292.35mm)	1/2" (12.70mm)	\$27.25	13219	100" (2540mm)	5/8" (15.88mm)	\$37.65
11482	90-1/2" (2298.70mm)	5/8" (15.88mm)	\$33.63	10260	100" (2540mm)	5/8" (15.88mm)	\$43.68
6505	90-1/2" (2298.70mm)	1/2" (12.70mm)	\$28.95	10261	100" (2540mm)	5/8" (15.88mm)	\$48.45
11502	90-29/32" (2309.02mm)	21/32" (16.67mm)	\$26.50	11468	101" (2565.4mm)	5/8" (15.88mm)	\$32.90
12983	91" (2311.4mm)	5/8" (15.88mm)	\$29.12	11867	101" (2565.4mm)	1/2" (12.70mm)	\$36.58
7673	91-1/4" (2317.75mm)	1/2" (12.70mm)	\$28.50	12442	101" (2565.4mm)	5/8" (15.88mm)	\$38.96

### OEM BELTS BY SIZE

Order Number	Length	Width	Sugg List	Order Number	Length	Width	Sugg List
12256	101-1/4" (2571.75mm)	1/2" (12.70mm)	\$33.17	12318	114" (2895.6mm)	1/2" (12.70mm)	\$36.35
13251	101-13/32" (2575.72mm)	1/2" (12.70mm)	\$46.64	12423	114" (2895.6mm)	1/2" (12.70mm)	\$67.25
8442	101-11/16" (2582.86mm)	1/2" (12.70mm)	\$29.95	12373	114-1/2" (2908.30mm)	1/2" (12.70mm)	\$36.35
10751	102" (2590.8mm)	1/2" (12.70mm)	\$32.82	10033	114-13/16" (2916.24mm)	21/32" (16.67mm)	\$36.74
12238	102" (2590.8mm)	21/32" (16.67mm)	\$39.78	10403	115" (2921mm)	11/16" (17.46mm)	\$64.24
13456	102-7/8" (2613.03mm)	5/8" (15.88mm)	\$40.59	12678	115-1/4" (2927.35mm)	1/2" (12.70mm)	\$47.38
12051	103" (2616.2mm)	1/2" (12.70mm)	\$27.22	13454	115-9/32" (2928.14mm)	5/8" (15.88mm)	\$43.03
7171	103" (2616.2mm)	1/2" (12.70mm)	\$32.45	12415	116" (2946.4mm)	1/2" (12.70mm)	\$27.83
7129	103-3/32" (2618.58mm)	1/2" (12.70mm)	\$32.95	12237	116-1/8" (2949.58mm)	5/8" (15.88mm)	\$53.76
12790	103-1/4" (2622.55mm)	1/2" (12.70mm)	\$33.27	10046	116-3/4" (2965.45mm)	21/32" (16.67mm)	\$65.04
6837	103-1/2" (2628.90mm)	AA	\$49.57	12928	117" (2971.8mm)	1/2" (12.70mm)	\$51.20
10436	103-3/4" (2635.25mm)	1/2" (12.70mm)	\$36.98	9900	117" (2971.8mm)	1/2" (12.70mm)	\$50.45
11504	103-7/8" (2638.43mm)	5/8" (15.88mm)	\$58.73	12759	117" (2971.8mm)	5/8" (15.88mm)	\$56.11
10750	105" (2667mm)	1/2" (12.70mm)	\$31.64	12071	117-1/2" (2984.50mm)	5/8" (15.88mm)	\$48.71
11850	105" (2667mm)	1/2" (12.70mm)	\$33.20	8714	117-1/2" (2984.50mm)	5/8" (15.88mm)	\$59.40
870	105" (2667mm)	AA	\$41.95	11843	118-1/4" (3003.55mm)	1/2" (12.70mm)	\$28.78
13572	105-19/64" (2674.54mm)	1/2" (12.70mm)	\$47.96	12783	118-3/4" (3016.25mm)	5/8" (15.88mm)	\$55.58
12286	105-3/4" (2686.05mm)	1/2" (12.70mm)	\$22.79	14140	119-1/4" (3028.95mm)	1/2" (12.70mm)	\$68.75
10036	105-13/16" (2687.64mm)	21/32" (16.67mm)	\$50.05	13217	120" (3048mm)	5/8" (15.88mm)	\$50.16
14763	106-1/2" (2705.1mm)	4 Rib	\$90.30	10048	120" (3048mm)	21/32" (16.67mm)	\$87.99
10005	106-29/32" (2715.42mm)	1/2" (12.70mm)	\$67.25	10629	120-19/64" (3055.54mm)	5/8" (15.88mm)	\$70.81
10894	108" (2743.2mm)	5/8" (15.88mm)	\$54.46	10254	120-5/16" (3055.94mm)	17/32" (13.49mm)	\$40.59
10627	108-1/4" (2749.55mm)	5/8" (15.88mm)	\$59.97	10404	120-3/8" (3057.53mm)	21/32" (16.67mm)	\$76.70
9714	109" (2768.6mm)	5/8" (15.88mm)	\$36.25	12096	120-1/2" (3060.70mm)	5/8" (15.88mm)	\$48.60
11845	109-7/64" (2771.38mm)	1/2" (12.70mm)	\$39.08	14570	121" (3073.4mm)	5/8" (15.88mm)	\$48.80
13499	110" (2794mm)	1/2" (12.70mm)	\$69.39	12769	122" (3098.8mm)	1/2" (12.70mm)	\$41.14
8768	110-1/4" (2800.35mm)	5/8" (15.88mm)	\$42.50	10387	122-1/8" (3101.98")	1/2" (12.70mm)	\$38.22
12098	110-1/2" (2806.70mm)	5/8" (15.88mm)	\$48.20	12609	122-1/2" (3111.50mm)	1/2" (12.70mm)	\$31.80
11820	110-29/32" (2817.02mm)	5/8" (15.88mm)	\$40.41	13255	123" (3124.2mm)	5/8" (15.88mm)	\$59.64
13570	111" (2819.4mm)	1/2" (12.70mm)	\$59.00	10411	123-15/16" (3148.01mm)	21/32" (16.67mm)	\$65.72
12610	111-13/64" (2824.56mm)	5/8" (15.88mm)	\$33.09	12072	125-1/2" (3187.70mm)	5/8" (15.88mm)	\$59.70
12077	111-3/8" (2828.93mm)	5/8" (15.88mm)	\$44.18	6874	126-3/16" (3205.16mm)	1/2" (12.70mm)	\$41.95
9014	111-11/25" (2830.58mm)	5/8" (15.88mm)	\$51.39	13442	126-55/64" (3222.23mm)	5/8" (15.88mm)	\$65.32
14130	112-1/8" (2847.98mm)	1/2" (12.70mm)	\$54.18	7837	127-7/64" (3228.58mm)	1/2" (12.70mm)	\$43.70
13474	112-1/4" (2851.15mm)	5/8" (15.88mm)	\$52.43	12416	127-19/64" (3233.34mm)	1/2" (12.70mm)	\$29.00
11997	112-1/2" (2857.50mm)	5/8" (15.88mm)	\$29.49	10407	128-13/32" (3261.52mm)	21/32" (16.67mm)	\$64.27
10886	112-1/2" (2857.50mm)	1/2" (12.70mm)	\$48.77	14390	128-3/4" (3270.25mm)	5/8" (15.88mm)	\$103.11
12095	112-1/2" (2857.50mm)	5/8" (15.88mm)	\$51.40	9862	128-13/16" (3271.8375mm)	5/8" (15.88mm)	\$48.64
14811	113-1/10" (2872.74mm)	1/2" (12.70mm)	\$31.70				

*OEM BELTS BY SIZE*

Order Number	Length	Width	Sugg List	Order Number	Length	Width	Sugg List
10011	130-13/16" (3322.64mm)	21/32" (16.67mm)	\$40.50	13444	143-1/2" (3644.90mm)	5/8" (15.88mm)	\$73.95
12667	131-7/64" (3330.18mm)	5/8" (15.88mm)	\$43.00	12401	145" (3683mm)	5/8" (15.88mm)	\$59.05
12814	131-1/2" (3340.10mm)	5/8" (15.88mm)	\$60.77	10852	145-3/8" (3692.53mm)	5/8" (15.88mm)	\$45.61
12264	132" (3352.8mm)	1/2" (12.70mm)	\$43.96	14363	145-1/2" (3695.70mm)	5/8" (15.88mm)	\$56.70
11853	132-3/4" (3371.85mm)	5/8" (15.88mm)	\$38.95	12425	146-7/64" (3711.18mm)	1/2" (12.70mm)	\$34.47
10034	132-13/16" (3373.44mm)	21/32" (16.67mm)	\$56.32	9016	146-3/16" (3713.16mm)	5/8" (15.88mm)	\$61.60
11847	133-45/64" (3396.06mm)	5/8" (15.88mm)	\$59.98	12560	146-1/4" (3714.75mm)	1/2" (12.70mm)	\$52.54
11844	134" (3403.6mm)	1/2" (12.70mm)	\$39.07	12443	147" (3733.8mm)	5/8" (15.88mm)	\$62.16
10038	134-1/4" (3409.95mm)	1/2" (12.70mm)	\$44.64	14639	147-2/5" (3743.96mm)	5/8" (15.88mm)	\$98.30
10626	134-5/16" (3411.54mm)	5/8" (15.88mm)	\$76.31	10745	147-1/2" (3746.50mm)	5/8" (15.88mm)	\$57.25
13443	135" (3429mm)	5/8" (15.88mm)	\$69.57	11863	148" (3759.2mm)	5/8" (15.88mm)	\$48.42
12097	135-1/2" (3441.70mm)	5/8" (15.88mm)	\$53.55	10365	148" (3759.2mm)	21/32" (16.67mm)	\$74.46
12073	135-1/2" (3441.70mm)	5/8" (15.88mm)	\$59.70	12719	148-1/4" (3765.55mm)	5/8" (15.88mm)	\$63.23
12399	135-1/2" (3441.70mm)	5/8" (15.88mm)	\$60.64	10849	148-1/2" (3771.90mm)	5/8" (15.88mm)	\$46.89
10405	135-1/2" (3441.70mm)	21/32" (16.67mm)	\$90.64	12108	150" (3810mm)	5/8" (15.88mm)	\$56.50
10037	136-41/64" (3470.67mm)	5/8" (15.88mm)	\$73.22	14068	150" (3810mm)	5/8" (15.88mm)	\$110.30
14593	137" (3479.8mm)	5/8" (15.88mm)	\$77.64	11024	150-13/64" (3815.16mm)	5/8" (15.88mm)	\$67.11
10744	137-1/2" (3492.50mm)	5/8" (15.88mm)	\$52.95	14762	150-9/10" (3832.86mm)	5/8" (15.88mm)	\$84.20
11661	137-29/32" (3502.82mm)	5/8" (15.88mm)	\$63.62	12109	151-1/2" (3848.10mm)	5/8" (15.88mm)	\$64.40
10861	138-1/4" (3511.55mm)	5/8" (15.88mm)	\$45.03	12320	152" (3860.8mm)	5/8" (15.88mm)	\$55.55
11864	138-3/4" (3524.25mm)	5/8" (15.88mm)	\$45.19	11032	152-7/64" (3863.58mm)	5/8" (15.88mm)	\$64.67
10437	138-7/8" (3527.43mm)	17/32" (13.49mm)	\$33.98	13158	152-1/4" (3867.15mm)	1/2" (12.70mm)	\$66.46
8075	139" (3530.6mm)	1/2" (12.70mm)	\$34.95	12100	153-1/2" (3898.90mm)	5/8" (15.88mm)	\$57.60
10044	139-61/64" (3554.81mm)	5/8" (15.88mm)	\$71.78	10040	154" (3911.6mm)	21/32" (16.67mm)	\$78.67
10850	140" (3556mm)	5/8" (15.88mm)	\$44.68	12371	154-7/8" (3933.83mm)	5/8" (15.88mm)	\$71.66
12672	140-1/10" (3558.54mm)	1/2" (12.70mm)	\$82.89	14209	154-7/8" (3933.83mm)	5/8" (15.88mm)	\$81.53
12718	140-3/4" (3575.05mm)	5/8" (15.88mm)	\$63.23	11025	157-9/32" (3994.94mm)	5/8" (15.88mm)	\$72.84
12099	141" (3581.4mm)	5/8" (15.88mm)	\$55.55	13256	158" (4013.2mm)	5/8" (15.88mm)	\$62.89
12461	141-7/64" (3584.18mm)	1/2" (12.70mm)	\$43.45	12106	158" (4013.2mm)	5/8" (15.88mm)	\$65.20
14733	141-1/2" (3594.10mm)	1/2" (12.70mm)	\$37.73	14166	158" (4013.2mm)	1/2" (12.70mm)	\$79.95
12760	141-47/64" (3600.05mm)	5/8" (15.88mm)	\$59.00	12653	159-5/64" (4040.58mm)	5/8" (15.88mm)	\$74.55
14848	141-3/4" (3600.45mm)	5/8" (15.88mm)	\$60.20	12321	160-13/64" (4069.16mm)	5/8" (15.88mm)	\$55.85
10051	142-1/10" (3609.34mm)	21/32" (16.67mm)	\$72.04	14766	160-3/5" (4079.24mm)	5/8" (15.88mm)	\$104.20
11034	142-37/64" (3621.48mm)	5/8" (15.88mm)	\$48.42	14243	161-13/32" (4099.72mm)	5/8" (15.88mm)	\$54.98
12319	143" (3632.2mm)	5/8" (15.88mm)	\$38.00	10815	162-1/8" (4117.98mm)	7/8" (22.23mm)	\$131.07
12768	143" (3632.2mm)	5/8" (15.88mm)	\$55.98	12233	162-1/2" (4127.50mm)	5/8" (15.88mm)	\$79.89
10251	143-5/32" (3636.17mm)	5/8" (15.88mm)	\$76.71	12452	162-51/64" (4135.04mm)	21/32" (16.67mm)	\$68.38
10630	143-5/16" (3640.14mm)	1/2" (12.70mm)	\$46.95	12791	162-29/32" (4137.82mm)	1/2" (12.70mm)	\$59.07
12559	143-1/2" (3644.90mm)	1/2" (12.70mm)	\$56.30	12107	163" (4140.2mm)	5/8" (15.88mm)	\$62.90

### *OEM BELTS BY SIZE*

<b>Order Number</b>	<b>Length</b>	<b>Width</b>	<b>Sugg List</b>
10823	163-1/2" (4152.90mm)	5/8" (15.88mm)	\$76.17
10010	164-13/16" (4186.24mm)	21/32" (16.67mm)	\$51.87
10847	165-1/2" (4203.70mm)	5/8" (15.88mm)	\$56.49
10041	169-15/32" (4304.51mm)	5/8" (15.88mm)	\$115.36
14000	171-1/4" (4349.75mm)	5/8" (15.88mm)	\$64.95
14764	172-3/4" (4387.85mm)	5/8" (15.88mm)	\$117.05
14217	175-3/4" (4464.05mm)	5/8" (15.88mm)	\$77.96
14318	175-7/8" (4467.225mm)	5/8" (15.88mm)	\$118.49
12824	175-29/32" (4468.02mm)	5/8" (15.88mm)	\$80.94
12867	176" (4470.4mm)	5/8" (15.88mm)	\$80.94
12322	176-51/64" (4490.64mm)	5/8" (15.88mm)	\$60.00
14062	178-1/4" (4527.55mm)	5/8" (15.88mm)	\$63.33
10845	180" (4572mm)	5/8" (15.88mm)	\$61.13
10824	183-3/8" (4657.73mm)	5/8" (15.88mm)	\$78.19
12323	184-51/64" (4693.84mm)	5/8" (15.88mm)	\$58.50
14756	184-9/10" (4696.46mm)	1/2" (12.70mm)	\$124.76
14165	186" (4724.4mm)	5/8" (15.88mm)	\$105.30
14061	191-3/20" (4855.21mm)	5/8" (15.88mm)	\$65.55
10846	195" (4953mm)	5/8" (15.88mm)	\$59.76
10825	198-1/2" (5041.90mm)	5/8" (15.88mm)	\$90.12
14167	198-3/4" (5048.25mm)	5/8" (15.88mm)	\$108.65
12690	204-1/2" (5194.30mm)	5/8" (15.88mm)	\$85.95
12691	213-1/2" (5422.90mm)	5/8" (15.88mm)	\$84.75
14786	216" (5486.4mm)	5/8" (15.88mm)	\$85.97
14366	219-1/4" (5568.95mm)	5/8" (15.88mm)	\$125.21
12805	226" (5740.4mm)	5/8" (15.88mm)	\$114.00
12692	228-23/32" (5809.46mm)	5/8" (15.88mm)	\$109.95
12729	242" (6146.8mm)	5/8" (15.88mm)	\$106.96
12730	264" (6705.6mm)	5/8" (15.88mm)	\$120.25

**3/8"**

Order Number	Length	Length (mm)	Belt #	Sugg List
7429	24"	609.6	3L240	\$10.80
7430	25"	635	3L250	\$10.80
7431	26"	660.4	3L260	\$10.80
7432	27"	685.8	3L270	\$11.27
7433	28"	711.2	3L280	\$11.27
7434	29"	736.6	3L290	\$11.27
7435	30"	762	3L300	\$13.46
7436	31"	787.4	3L310	\$13.46
7437	32"	812.8	3L320	\$13.46
7438	33"	838.2	3L330	\$13.46
7439	34"	863.6	3L340	\$13.46
7440	35"	889	3L350	\$13.46
7441	36"	914.4	3L360	\$14.73
7442	37"	939.8	3L370	\$14.73
7443	38"	965.2	3L380	\$14.73
7444	39"	990.6	3L390	\$14.73
7445	40"	1016	3L400	\$15.77
7446	41"	1041.4	3L410	\$15.77
7447	42"	1066.8	3L420	\$15.77
7448	43"	1092.2	3L430	\$15.77
7449	44"	1117.6	3L440	\$15.77
7450	45"	1143	3L450	\$16.93
7451	46"	1168.4	3L460	\$16.93
7452	47"	1193.8	3L470	\$16.93
7453	48"	1219.2	3L480	\$16.93
7454	49"	1244.6	3L490	\$16.93
7455	50"	1270	3L500	\$16.93
7466	23"	584.2	A021	\$13.46

**1/2"**

Order Number	Length	Length (mm)	Belt #	Sugg List
7467	24"	609.6	A022	\$13.46
7468	25"	635	A023	\$13.46
7469	26"	660.4	A024	\$13.46
7470	27"	685.8	A025	\$13.46
7471	28"	711.2	A026	\$13.46
7472	29"	736.6	A027	\$13.46
7473	30"	762	A028	\$14.62
7474	31"	787.4	A029	\$14.62
7475	32"	812.8	A030	\$14.62
7476	33"	838.2	A031	\$14.62
7477	34"	863.6	A032	\$14.62
7478	35"	889	A033	\$14.62
7479	36"	914.4	A034	\$14.62
7480	37"	939.8	A035	\$14.62
7481	38"	965.2	A036	\$14.62
7482	39"	990.6	A037	\$14.62
7483	40"	1016	A038	\$17.62
7484	41"	1041.4	A039	\$17.62
7485	42"	1066.8	A040	\$17.62
7486	43"	1092.2	A041	\$17.62
7487	44"	1117.6	A042	\$17.62
7488	45"	1143	A043	\$17.62
7489	46"	1168.4	A044	\$17.62
7490	47"	1193.8	A045	\$17.62
7491	48"	1219.2	A046	\$17.62
7492	49"	1244.6	A047	\$17.62
7493	50"	1270	A048	\$18.77
7494	51"	1295.4	A049	\$18.77
7495	52"	1320.8	A050	\$18.77
7496	53"	1346.2	A051	\$18.77
7497	54"	1371.6	A052	\$18.77
7498	55"	1397	A053	\$18.77
7499	56"	1422.4	A054	\$18.77
7500	57"	1447.8	A055	\$18.77
7501	58"	1473.2	A056	\$18.77

1/2"

Order Number	Length	Length (mm)	Belt #	Sugg List
7502	59"	1498.6	A057	\$18.77
7503	60"	1524	A058	\$20.21
7504	61"	1549.4	A059	\$20.21
7505	62"	1574.8	A060	\$20.21
7506	63"	1600.2	A061	\$20.21
7507	64"	1625.6	A062	\$20.21
7508	65"	1651	A063	\$20.21
7509	66"	1676.4	A064	\$20.21
7510	67"	1701.8	A065	\$20.21
7511	68"	1727.2	A066	\$20.21
7512	69"	1752.6	A067	\$22.24
7513	70"	1778	A068	\$22.82
7514	71"	1803.4	A069	\$22.82
7515	72"	1828.8	A070	\$22.82
7516	73"	1854.2	A071	\$22.82
7517	74"	1879.6	A072	\$22.82
7518	75"	1905	A073	\$22.82
7519	76"	1930.4	A074	\$22.82
7520	77"	1955.8	A075	\$22.82
7521	78"	1981.2	A076	\$22.82
7522	79"	2006.6	A077	\$22.82
7523	80"	2032	A078	\$25.99
7524	81"	2057.4	A079	\$25.99
7525	82"	2082.8	A080	\$25.99
7526	83"	2108.2	A081	\$25.99
7527	84"	2133.6	A082	\$25.99
7528	85"	2159	A083	\$27.14
7529	86"	2184.4	A084	\$27.14
7530	87"	2209.8	A085	\$27.14
7531	88"	2235.2	A086	\$27.14
7532	89"	2260.6	A087	\$27.14
7533	90"	2286	A088	\$27.14
7534	91"	2311.4	A089	\$28.30
7535	92"	2336.8	A090	\$28.30
7536	93"	2362.2	A091	\$28.30

1/2"

Order Number	Length	Length (mm)	Belt #	Sugg List
7537	94"	2387.6	A092	\$28.30
7538	95"	2413	A093	\$28.30
7539	96"	2438.4	A094	\$28.30
7540	97"	2463.8	A095	\$28.30
7541	98"	2489.2	A096	\$28.30
7542	99"	2514.6	A097	\$30.61
7543	100"	2540	A098	\$30.61
7544	101"	2565.4	A099	\$30.61
7545	102"	2590.8	A0100	\$30.61
7546	103"	2616.2	A0101	\$31.76
7547	104"	2641.6	A0102	\$31.76
7548	105"	2667	A0103	\$31.76
7549	106"	2692.4	A0104	\$32.92
7550	107"	2717.8	A0105	\$32.92
7551	108"	2743.2	A0106	\$32.92
7552	109"	2768.6	A0107	\$32.92
7553	110"	2794	A0108	\$34.07
7554	111"	2819.4	A0109	\$34.07
7555	112"	2844.8	A0110	\$34.07
7556	113"	2870.2	A0111	\$34.07
7557	114"	2895.6	A0112	\$34.07

5/8"

Order Number	Length	Length (mm)	Belt #	Sugg List
7571	26"	660.4	B023	\$16.93
7572	27"	685.8	B024	\$16.93
7573	28"	711.2	B025	\$16.93
7574	29"	736.6	B026	\$16.93
7575	30"	762	B027	\$20.39
7576	31"	787.4	B028	\$20.39
7577	32"	812.8	B029	\$20.39
7578	33"	838.2	B030	\$20.39
7579	34"	863.6	B031	\$20.39
7580	35"	889	B032	\$20.39
7581	36"	914.4	B033	\$20.39
7582	37"	939.8	B034	\$20.39
7583	38"	965.2	B035	\$20.39
7584	39"	990.6	B036	\$23.05
7585	40"	1016	B037	\$22.70
7586	41"	1041.4	B038	\$22.70
7587	42"	1066.8	B039	\$22.70
7588	43"	1092.2	B040	\$22.70
7589	44"	1117.6	B041	\$22.70
7590	45"	1143	B042	\$22.70
7591	46"	1168.4	B043	\$22.70
7592	47"	1193.8	B044	\$23.86
7593	48"	1219.2	B045	\$23.86
7594	49"	1244.6	B046	\$23.86
7595	50"	1270	B047	\$25.01
7596	51"	1295.4	B048	\$25.01
7597	52"	1320.8	B049	\$25.01
7598	53"	1346.2	B050	\$26.17
7599	54"	1371.6	B051	\$26.17
7600	55"	1397	B052	\$26.17
7601	56"	1422.4	B053	\$26.17
7602	57"	1447.8	B054	\$26.17
7603	58"	1473.2	B055	\$26.17
7604	59"	1498.6	B056	\$28.48
7605	60"	1524	B057	\$28.48

5/8"

Order Number	Length	Length (mm)	Belt #	Sugg List
7606	61"	1549.4	B058	\$28.48
7607	62"	1574.8	B059	\$28.48
7608	63"	1600.2	B060	\$28.48
7609	64"	1625.6	B061	\$30.79
7610	65"	1651	B062	\$30.79
7611	66"	1676.4	B063	\$30.79
7612	67"	1701.8	B064	\$30.79
7613	68"	1727.2	B065	\$30.79
7614	69"	1752.6	B066	\$30.79
7615	70"	1778	B067	\$35.41
7616	71"	1803.4	B068	\$35.41
7617	72"	1828.8	B069	\$35.41
7618	73"	1854.2	B070	\$35.41
7619	74"	1879.6	B071	\$35.41
7620	75"	1905	B072	\$35.41
7621	76"	1930.4	B073	\$35.41
7622	77"	1955.8	B074	\$35.41
7623	78"	1981.2	B075	\$35.41
7624	79"	2006.6	B076	\$35.41
7625	80"	2032	B077	\$37.72
7626	81"	2057.4	B078	\$37.72
7627	82"	2082.8	B079	\$37.72
7628	83"	2108.2	B080	\$37.72
7629	84"	2133.6	B081	\$37.72
7630	85"	2159	B082	\$37.72
7631	86"	2184.4	B083	\$37.72
7632	87"	2209.8	B084	\$37.72
7633	88"	2235.2	B085	\$37.72
7634	89"	2260.6	B086	\$37.72
7635	90"	2286	B087	\$40.03
7636	91"	2311.4	B088	\$40.03
7637	92"	2336.8	B089	\$40.03
7638	93"	2362.2	B090	\$40.03
7639	94"	2387.6	B091	\$40.03
7640	95"	2413	B092	\$40.03

5/8"

Order Number	Length	Length (mm)	Belt #	Sugg List
7641	96"	2438.4	B093	\$41.18
7642	97"	2463.8	B094	\$41.18
7643	98"	2489.2	B095	\$41.18
7644	99"	2514.6	B096	\$41.18
7645	100"	2540	B097	\$41.18
7646	101"	2565.4	B098	\$41.18
7647	102"	2590.8	B099	\$42.34
7648	103"	2616.2	B0100	\$42.34
7649	104"	2641.6	B0101	\$42.34
7650	105"	2667	B0102	\$43.49
7651	106"	2692.4	B0103	\$43.49
7652	107"	2717.8	B0104	\$43.49
7653	108"	2743.2	B0105	\$44.65
7654	109"	2768.65	B0106	\$44.65
7655	110"	2794	B0107	\$44.65
7656	111"	2819.4	B0108	\$45.80
7657	112"	2844.8	B0109	\$45.80
7658	113"	2870.2	B0110	\$45.80
7659	114"	2895.6	B0111	\$45.80

# ARIENS

<b>ORDER #:</b> 13284	Snowblower Belt. Fits 6 HP Sno-Thro models. Traction Drive. Set of (2) matched belts.	<b>SUGG LIST:</b> <b>\$29.20</b> 1/4" (6.35mm)x 27" (685.8mm)
<b>ORDER #:</b> 8762	Snowblower Belt. Fits models 1975-1978 & Sno-Tro model. Drive belt 4 & 5 hp, 1969-1974 models 922018, 922019, 922020 & 922021. Raw edge, traction drive belt. This belt sold in matching pairs.	<b>SUGG LIST:</b> <b>\$28.95</b> 1/4" (6.35mm)x 27-1/8" (688.98mm)
<b>ORDER #:</b> 8429	Snowblower Belt. Raw edge belt. Fits 92400 series. Models 00026, 27, 32, 33, 36, 38, 39, 46, 48, 49 & some 51, 52.	<b>SUGG LIST:</b> <b>\$12.75</b> 3/8" (9.53mm)x 33" (838.2mm)
<b>ORDER #:</b> 8430	Snowblower Belt. Raw edge belt. Fits models 924080, 924082, 924084, 924085, 924086, 924087, 8-12 hp engines.	<b>SUGG LIST:</b> <b>\$19.95</b> 3/8" (9.53mm)x 34" (863.6mm)
<b>ORDER #:</b> 8425	Snowblower Belt. Raw edge belt.	<b>SUGG LIST:</b> <b>\$15.70</b> 1/2" (12.70mm)x 34-1/2" (876.30mm)
<b>ORDER #:</b> 13509	Snowblower Belt. Auger Drive belt fits 932 series Snow Thrower models. Laminated, Aramid cord construction.	<b>SUGG LIST:</b> <b>\$19.45</b> 1/2" (12.70mm)x 34-7/8" (885.83mm)
<b>ORDER #:</b> 13505	Snowblower Belt. Fits 924 series Snow Thrower models. Laminated, Aramid cord construction.	<b>SUGG LIST:</b> <b>\$18.95</b> 1/2" (12.70mm)x 35-13/32" (899.32mm)
<b>ORDER #:</b> 8432	Snowblower Belt. Wrapped belt. Fits older model Ariens with single belt.	<b>SUGG LIST:</b> <b>\$15.95</b> 3/8" (9.53mm)x 35-1/2" (901.70mm)
<b>ORDER #:</b> 8426	Snowblower Belt. Raw edge belt. Fits models 924085, 924087, 924091 & 924092, 12 hp engines.	<b>SUGG LIST:</b> <b>\$16.95</b> 3/8" (9.53mm)x 36" (914.4mm)
<b>ORDER #:</b> 8428	Snowblower Belt. Raw edge belt. Fits models 924084, 924086, 10 hp engines.	<b>SUGG LIST:</b> <b>\$24.95</b> 1/2" (12.70mm)x 37" (939.8mm)
<b>ORDER #:</b> 13508	Snowblower Belt. Auger Drive belt fits 926 series Snow Thrower models. Laminated, Aramid cord construction.	<b>SUGG LIST:</b> <b>\$25.30</b> 1/2" (12.70mm)x 37-7/64" (942.58mm)

<b>ORDER #:</b> 13506	Snowblower Belt. Auger Drive belt fits 924 series Snow Thrower models. Laminated, Aramid cord construction.	<b>SUGG LIST:</b> <b>\$21.95</b> 1/2" (12.70mm)x 37-37/64" (954.48mm)
<b>ORDER #:</b> 13507	Snowblower Belt. Auger Drive belt fits 926 series Snow Thrower models. Laminated, Aramid cord construction.	<b>SUGG LIST:</b> <b>\$29.85</b> 1/2" (12.70mm)x 37-63/64" (964.80mm)
<b>ORDER #:</b> 8427	Snowblower Belt. Raw edge belt. Fits models 924085, 924087, 924091 & 924092, 10 hp engines.	<b>SUGG LIST:</b> <b>\$18.30</b> 1/2" (12.70mm)x 39" (990.6mm)
<b>ORDER #:</b> 8431	Snowblower Belt. Raw edge belt. Fits models 924082, 8 hp engines.	<b>SUGG LIST:</b> <b>\$16.95</b> 1/2" (12.70mm)x 40" (1016mm)

## AYP

<b>ORDER #:</b> 14513	Snowthrower Belt. Fits models 1827 EXLT, 1830 EXLT Snowthrowers. Wrapped molded, Aramid cord construction, single cover.	<b>SUGG LIST:</b> <b>\$18.90</b> 1/2" (12.70mm)x 29-7/16" (747.71mm)
<b>ORDER #:</b> 13118	Drive Belt. 506 29 67-02. Fits K750 cut off saws. Also replaces Shindaiwa 38010-64131 & fits models EC7500, EC7600. 6 rib, polyester cord construction.	<b>SUGG LIST:</b> <b>\$21.15</b> 9/16" (14.29mm)x 31-57/64" (810.02mm)
<b>ORDER #:</b> 12480	Deck Drive Belt. Fits 21" rear bagger, self propelled mower. General purpose, Aramid cord construction, double clutching cover.	<b>SUGG LIST:</b> <b>\$12.90</b> 3/8" (9.53mm)x 32" (812.8mm)
<b>ORDER #:</b> 10306	Drive Belt. Fits self propelled walkbehind mowers. Fiberglass cord construction.	<b>SUGG LIST:</b> <b>\$10.75</b> 3/8" (9.53mm)x 32-3/16" (817.56mm)
<b>ORDER #:</b> 9848	Drive Belt. Polyester cord construction. Raw edge.	<b>SUGG LIST:</b> <b>\$10.75</b> 3/8" (9.53mm)x 32-1/2" (825.50mm)
<b>ORDER #:</b> 14117	Snowthrower Belt. Fits models 10527SB, 10527SBE, 10530SBE, 1130SBL, 1130SBE, 5224STE, 924SB, 924SBE, 927SB. Snowthrowers. Raw edge, Aramid cord construction.	<b>SUGG LIST:</b> <b>\$30.12</b> 5/8" (15.88mm)x 37-3/4" (958.85mm)
<b>ORDER #:</b> 14116	Snowthrower Belt. Fits models PP1150E27, PP208E24, PP208EPS24 Snowthrowers. Raw edge, Aramid cord construction.	<b>SUGG LIST:</b> <b>\$30.12</b> 5/8" (15.88mm)x 38" (965.2mm)

<b>ORDER #:</b> 14512	Snowthrower Belt. Fits models 1130 SBE OV, 11524E, 14527E, 145270 Snowthrowers. Raw edge, Aramid cord construction.	<b>SUGG LIST:</b> <b>\$31.20</b> 5/8" (15.88mm)x 38-31/32" (989.81mm)
<b>ORDER #:</b> 9769	V Belt. Polyester cord construction. (12.7 mm x 1054 mm)	<b>SUGG LIST:</b> <b>\$16.13</b> 1/2" (12.70mm)x 41-1/2" (1054.10mm)
<b>ORDER #:</b> 9765	V Belt. *Aramid fiber.	<b>SUGG LIST:</b> <b>\$17.45</b> 1/2" (12.70mm)x 52" (1320.8mm)
<b>ORDER #:</b> 13477	Pump Drive Rib Belt. Fits models ZTH5223A, ZTH5225A, ZTH6125A. "K" section, 5 ribs, Neoprene, Polyester cord construction.	<b>SUGG LIST:</b> <b>\$27.80</b> 5/8" (15.88mm)x 57-15/32" (1459.71mm)
<b>ORDER #:</b> 10949	Pump Belt. Fits 48" zero turn riders. Raw edge, laminated, aramid cord construction.	<b>SUGG LIST:</b> <b>\$26.17</b> 1/2" (12.70mm)x 59-15/16" (1522.41mm)
<b>ORDER #:</b> 8512	Transmission Belt. Fits 11 hp 36" cut model L0815AR, front engine rider. Covered.	<b>SUGG LIST:</b> <b>\$17.10</b> 1/2" (12.70mm)x 69" (1752.6mm)
<b>ORDER #:</b> 8510	Blade Belt. Fits 8 hp 36" cut models L1252AR, L8212AR, front engine riders. Covered.	<b>SUGG LIST:</b> <b>\$23.60</b> 1/2" (12.70mm)x 69-1/2" (1765.30mm)
<b>ORDER #:</b> 14359	Deck Belt. Fits 30" models PB30 & WELRVBA (532-44-15-97). Aramid cord, dry cover.	<b>SUGG LIST:</b> <b>\$47.36</b> 1/2" (12.70mm)x 72" (1828.8mm)
<b>ORDER #:</b> 14731	V Belt. Hydro belt, fits model MZ6128, cogged. Aramid cord construction.	<b>SUGG LIST:</b> <b>\$35.07</b> 1/2" (12.70mm)x 75-3/8" (1914.53mm)
<b>ORDER #:</b> 8463	Deck Belt. Fits 10 hp 36" cut model WP1036A & 11 hp 36" cut model T1136B. Front engine riders. Covered.131290X	<b>SUGG LIST:</b> <b>\$17.21</b> 1/2" (12.70mm)x 78-1/2" (1993.90mm)
<b>ORDER #:</b> 9767	Drive Belt. Fits 10 & 11 HP, 36" cut front engine riders. *Aramid fiber.	<b>SUGG LIST:</b> <b>\$40.19</b> 1/2" (12.70mm)x 79" (2006.6mm)
<b>ORDER #:</b> 6901	Blade Drive Belt. Fits 18 hp rider tractors with electric clutch. Also fits 36", 38" & 44". Covered.	<b>SUGG LIST:</b> <b>\$21.51</b> 1/2" (12.70mm)x 79-7/64" (2009.38mm)

<b>ORDER #:</b> 6900	Belt. Covered.	<b>SUGG LIST:</b> <b>\$29.07</b> 1/2" (12.70mm)x 80" (2032mm)
<b>ORDER #:</b> 9336	Hydro Belt. Fits 42" & 44" cut, 18 & 18.5 hp engines. Models WE185H42F & Y18H44D. *Aramid fiber. 2 ply white. Covered.	<b>SUGG LIST:</b> <b>\$30.12</b> 1/2" (12.70mm)x 81-1/16" (2058.99mm)
<b>ORDER #:</b> 10008	Ground Drive Belt. Fits 42" AYP riders. *Aramid fiber.	<b>SUGG LIST:</b> <b>\$32.61</b> 1/2" (12.70mm)x 82" (2082.8mm)
<b>ORDER #:</b> 8464	Blade Belt. Fits 8 hp 36" cut model L1252AR, front engine rider. Covered.	<b>SUGG LIST:</b> <b>\$26.88</b> 1/2" (12.70mm)x 82-1/2" (2095.50mm)
<b>ORDER #:</b> 10078	Ground Drive Belt. *Aramid fiber. Fits 48" & 54". AYP riders & Poulan Pro units.	<b>SUGG LIST:</b> <b>\$36.74</b> 1/2" (12.70mm)x 82-1/2" (2095.50mm)
<b>ORDER #:</b> 11129	Belt. Fits 11 hp 36" cut. Wrapped 2 ply aramid cord construction.	<b>SUGG LIST:</b> <b>\$46.77</b> 1/2" (12.70mm)x 83" (2108.2mm)
<b>ORDER #:</b> 9368	Primary Deck Belt. Fits 46" & 50" cut, 16, 19, 20, 22 & 24 hp engines. Deck models YGT, YPT & PP. *Aramid fiber. Black cover.	<b>SUGG LIST:</b> <b>\$39.70</b> 1/2" (12.70mm)x 83-1/2" (2120.90mm)
<b>ORDER #:</b> 9367	Drive Belt. Fits 50" cut, 16 hp engines. Model 8209B89. *Aramid fiber. White cover.	<b>SUGG LIST:</b> <b>\$41.96</b> 1/2" (12.70mm)x 83-1/2" (2120.90mm)
<b>ORDER #:</b> 9312	Deck Belt. Fits 46" cut models. *Aramid fiber. Clutching cover. Covered.	<b>SUGG LIST:</b> <b>\$46.77</b> 1/2" (12.70mm)x 83-5/8" (2124.08mm)
<b>ORDER #:</b> 9337	Hydro Belt. Fits 42" cut, 14.5 & 16 hp engines. Model 9169A99. Neoprene. *Aramid fiber. Clutching cover. Covered.	<b>SUGG LIST:</b> <b>\$33.16</b> 1/2" (12.70mm)x 83-3/4" (2127.25mm)
<b>ORDER #:</b> 9964	Deck Belt. . Fits 36" side discharge models. *Aramid fiber.	<b>SUGG LIST:</b> <b>\$32.28</b> 1/2" (12.70mm)x 84-1/2" (2146.30mm)
<b>ORDER #:</b> 8781	Drive Belt. Fits Western Auto 50" cut, model 8228A49 with 20 hp Kohler engine. *Aramid fiber. Covered.	<b>SUGG LIST:</b> <b>\$46.26</b> 1/2" (12.70mm)x 84-1/2" (2146.30mm)

<b>ORDER #:</b> 9698	Primary Drive Belt. Tractor to mower for AYP 46" with 18 & 20 hp Kohler engines, model year '95 & '97. General purpose, polyester cord construction. Covered.	<b>SUGG LIST:</b> <b>\$38.73</b> 5/8" (15.88mm)x 85-3/8" (2168.53mm)
<b>ORDER #:</b> 11130	Belt. Fits 12 hp 38" cut. Wrapped 2 ply aramid cord construction.	<b>SUGG LIST:</b> <b>\$47.33</b> 1/2" (12.70mm)x 87" (2209.8mm)
<b>ORDER #:</b> 12892	Deck Drive Belt. Fits 42" mower drive belt. Wrapped molded, Aramid cord construction, double clutching cover, (color brown).	<b>SUGG LIST:</b> <b>\$48.47</b> 1/2" (12.70mm)x 87-41/64" (2226.07mm)
<b>ORDER #:</b> 7184	Blade Belt. Fits 38" front engine rider model 7122A29. Also fits Husky/Poulan. Covered.	<b>SUGG LIST:</b> <b>\$23.95</b> 1/2" (12.70mm)x 88" (2235.2mm)
<b>ORDER #:</b> 8516	Deck Belt. Fits 42" cut decks with double idler pulleys. Covered. Fits 54" mowers. Wrapped molded, neoprene, polyester cord construction. Clutching cover.	<b>SUGG LIST:</b> <b>\$37.11</b> 1/2" (12.70mm)x 88-3/8" (2244.73mm)
<b>ORDER #:</b> 10077	Secondary Deck Belt. Fits AYP & Poulan Pro units. Polyester cord construction.	<b>SUGG LIST:</b> <b>\$41.99</b> 5/8" (15.88mm)x 89" (2260.6mm)
<b>ORDER #:</b> 6902	Transmission Belt. Fits 38" cut model YT14. Covered.	<b>SUGG LIST:</b> <b>\$22.59</b> 1/2" (12.70mm)x 90" (2286mm)
<b>ORDER #:</b> 10076	Primary Deck Belt. Fits 48" riders. Polyester cord construction.	<b>SUGG LIST:</b> <b>\$43.05</b> 5/8" (15.88mm)x 90" (2286mm)
<b>ORDER #:</b> 11861	Deck Drive Belt. Fits new 38" rider. General purpose, Aramid cord construction, double clutching cover.	<b>SUGG LIST:</b> <b>\$26.89</b> 1/2" (12.70mm)x 90-1/4" (2292.35mm)
<b>ORDER #:</b> 8511	Deck Belt. Fits 12, 12.5, & 14 hp 42" cut models RL1242A, WP12542A, Y1442A, front engine riders. Covered.	<b>SUGG LIST:</b> <b>\$21.51</b> 1/2" (12.70mm)x 92-1/2" (2349.50mm)
<b>ORDER #:</b> 9945	Deck Belt. Fits AYP models XEG11082HAR & PP2050 Poulan Pro PTO. *Aramid fiber.	<b>SUGG LIST:</b> <b>\$21.76</b> 1/2" (12.70mm)x 93-1/2" (2374.9mm)
<b>ORDER #:</b> 9764	Engine to Transmission Belt. Polyester cord construction.	<b>SUGG LIST:</b> <b>\$26.24</b> 1/2" (12.70mm)x 95" (2413mm)

<b>ORDER #:</b> 9768	Drive Belt. *Aramid fiber.	<b>SUGG LIST:</b> <b>\$39.92</b> 1/2" (12.70mm)x 95" (2413mm)
<b>ORDER #:</b> 8784	Deck Belt. Secondary deck drive belt for 50" cut. *Aramid fiber. Covered.	<b>SUGG LIST:</b> <b>\$26.24</b> 1/2" (12.70mm)x 95-1/4" (2419.35mm)
<b>ORDER #:</b> 9697	Drive Belt. Fits model 24H4B3A & 8209A99. Fits 46" & 50" cut. 16, 22 & 24 hp engines. *Aramid fiber. Covered. Fits Poulan Pro 12012.	<b>SUGG LIST:</b> <b>\$24.95</b> 1/2" (12.70mm)x 95-1/2" (2425.70mm)
<b>ORDER #:</b> 12398	Deck Belt. General purpose, fiberglass cord construction, Double cover, clutching.	<b>SUGG LIST:</b> <b>\$36.58</b> 1/2" (12.70mm)x 95-11/16" (2430.46mm)
<b>ORDER #:</b> 13501	Deck Belt. Fits 38" side discharge models LT19538, LTH2038. Wrapped molded HA x 96.4" Aramid cord construction, double cover, clutching, (white color).	<b>SUGG LIST:</b> <b>\$37.25</b> 1/2" (12.70mm)x 96-13/32" (2448.72mm)
<b>ORDER #:</b> 12052	Transmission Belt. Fits AYP 48" decks. Wrapped-molded, Aramid cord construction.	<b>SUGG LIST:</b> <b>\$32.81</b> 1/2" (12.70mm)x 96-7/8" (2460.63mm)
<b>ORDER #:</b> 11862	Drive Belt. Wrapped-molded, Aramid cord construction, double cover, clutching, (brown color).	<b>SUGG LIST:</b> <b>\$32.81</b> 1/2" (12.70mm)x 97-13/32" (2474.12mm)
<b>ORDER #:</b> 10232	Blade Drive Belt. Secondary Drive Belt for 42" cut. Wrapped molded. General purpose, polyester cord construction, clutch cover.	<b>SUGG LIST:</b> <b>\$42.84</b> 21/32" (16.67mm)x 97-13/32" (2474.12mm)
<b>ORDER #:</b> 8462	Drive Belt. Fits 18 hp 42" cut model RY1842A, WP1842A, front engine riders. Covered.	<b>SUGG LIST:</b> <b>\$28.39</b> 1/2" (12.70mm)x 98-1/4" (2495.55mm)
<b>ORDER #:</b> 8465	Drive Belt. Fits 20 hp 50" cut model 951940, front engine rider. Covered.	<b>SUGG LIST:</b> <b>\$19.37</b> 1/2" (12.70mm)x 99" (2514.6mm)
<b>ORDER #:</b> 11867	Deck to Spindle Belt. Polyester cord, double cover.	<b>SUGG LIST:</b> <b>\$36.58</b> 1/2" (12.70mm)x 101" (2565.4mm)
<b>ORDER #:</b> 13251	Deck Belt. Fits 2010 model 42" decks. Wrapped-molded, aramid cord construction, double cover, clutching, (white).	<b>SUGG LIST:</b> <b>\$46.64</b> 1/2" (12.70mm)x 101-13/32" (2575.72mm)

<b>ORDER #:</b> 870	Belt. For 48" Deck 1992 & older. Double V.	<b>SUGG LIST:</b> <b>\$41.95</b> AAx 105" (2667mm)
<b>ORDER #:</b> 12286	Deck Drive Belt. Fits 2007 models with 46" twin blade decks. Double cover, Aramid cord construction.	<b>SUGG LIST:</b> <b>\$22.79</b> 1/2" (12.70mm)x 105-3/4" (2686.05mm)
<b>ORDER #:</b> 10005	Deck Belt. Fits 36" rear discharge lawn tractors. *Aramid fiber. Double "V"	<b>SUGG LIST:</b> <b>\$67.25</b> 1/2" (12.70mm)x 106-29/32" (2715.42mm)
<b>ORDER #:</b> 13499	Deck Belt. Fits 38" rear discharge models CTH2038, CTH2238. Wrapped molded HAA x 110.0" Aramid cord construction, double cover, clutching, (salt /pepper color).	<b>SUGG LIST:</b> <b>\$69.39</b> 1/2" (12.70mm)x 110" (2794mm)
<b>ORDER #:</b> 13474	Mule Drive Belt. Fits ZTH5223A, ZTH5225A, ZTH6125A. V-Belt. Aramid cord construction, laminated.	<b>SUGG LIST:</b> <b>\$52.43</b> 5/8" (15.88mm)x 112-1/4" (2851.15mm)
<b>ORDER #:</b> 12423	Deck Drive Belt. (AA x 114"). Fits new 42" rear discharge. General purpose, Aramid cord construction, double clutching cover.	<b>SUGG LIST:</b> <b>\$67.25</b> 1/2" (12.70mm)x 114" (2895.6mm)
<b>ORDER #:</b> 13442	Deck Belt. Fits model YTH2242 & YTH23V42LS, 42" fabricated deck. Wrapped-molded, aramid cord construction, double cover, clutching, (white color).	<b>SUGG LIST:</b> <b>\$65.32</b> 5/8" (15.88mm)x 126-55/64" (3222.23mm)
<b>ORDER #:</b> 13443	Deck Belt. Fits model YTH2648 & YTH24V48LS, 48" fabricated deck. Wrapped-molded, aramid cord construction, double cover, clutching, (white color).	<b>SUGG LIST:</b> <b>\$69.57</b> 5/8" (15.88mm)x 135" (3429mm)
<b>ORDER #:</b> 12399	Deck Belt. Fits 48" Decks, General Purpose, Aramid cord construction, double cover, clutching.	<b>SUGG LIST:</b> <b>\$60.64</b> 5/8" (15.88mm)x 135-1/2" (3441.70mm)
<b>ORDER #:</b> 11864	Deck Drive Belt. Fits 48" rider. Polyester cord, double cover.	<b>SUGG LIST:</b> <b>\$45.19</b> 5/8" (15.88mm)x 138-3/4" (3524.25mm)
<b>ORDER #:</b> 11034	Deck Belt.	<b>SUGG LIST:</b> <b>\$48.42</b> 5/8" (15.88mm)x 142-37/64" (3621.48mm)
<b>ORDER #:</b> 13444	Deck Belt. Fits model GTH27V52LS, 52" fabricated deck. Wrapped-molded, aramid cord construction, double cover, clutching, (white color).	<b>SUGG LIST:</b> <b>\$73.95</b> 5/8" (15.88mm)x 143-1/2" (3644.90mm)

<b>ORDER #:</b> 12401	Deck Belt. Fits models Husqvarna EZ4819 48", Z5426 54" decks, Poulan Pro ZTR, IZ4217 42". Laminated, Aramid cord construction.	<b>SUGG LIST:</b> <b>\$59.05</b> 5/8" (15.88mm)x 145" (3683mm)
<b>ORDER #:</b> 11863	Deck Drive Belt. Fits 54" rider. Neoprene, polyester cord, double cover.	<b>SUGG LIST:</b> <b>\$48.42</b> 5/8" (15.88mm)x 148" (3759.2mm)
<b>ORDER #:</b> 11032	Deck Belt. Fits 48" zero turn riders. Raw edge, laminated, aramid cord construction.	<b>SUGG LIST:</b> <b>\$64.67</b> 5/8" (15.88mm)x 152-7/64" (3863.58mm)
<b>ORDER #:</b> 12653	Drive Belt. Fits 52" deck models. Raw edge, Aramid cord construction, laminated.	<b>SUGG LIST:</b> <b>\$74.55</b> 5/8" (15.88mm)x 159-5/64" (4040.58mm)

## BOBCAT

<b>ORDER #:</b> 5242	Variable Speed Belt. 32" and 36" decks. Raw Edge.	<b>SUGG LIST:</b> <b>\$14.49</b> 5/8" (15.88mm)x 35-39/64" (904.48mm)
<b>ORDER #:</b> 8811	Transmission Belt. Transmission belt on newer gear drive machines. Raw edge, *Aramid fiber.	<b>SUGG LIST:</b> <b>\$12.02</b> 1/2" (12.70mm)x 36-1/8" (917.58mm)
<b>ORDER #:</b> 6836	Variable Speed Wheel Drive Belt. Double "A" Banded	<b>SUGG LIST:</b> <b>\$45.95</b> 1-1/8" (28.58mm)x 44-45/64" (1135.46mm)
<b>ORDER #:</b> 14571	Hydro Belt. Fits Hydro mower walk behind, Hydro Mower XM series, Hydro 930300 thru 930307 and 930309 walk behind units.	<b>SUGG LIST:</b> <b>\$13.05</b> 1/2" (12.70mm)x 46" (1168.4mm)
<b>ORDER #:</b> 8810	Gear Drive Belt. Cogged belt for all 94, 95, 96 Bobcats. Raw edge, cogged, *Aramid fiber construction. 2 rib band belt.	<b>SUGG LIST:</b> <b>\$50.50</b> 1/2" (12.70mm)x 54" (1371.6mm)
<b>ORDER #:</b> 6969	Gear Drive Belt. Double "A" Raw Edge.	<b>SUGG LIST:</b> <b>\$50.40</b> 1/2" (12.70mm)x 55-31/32" (1421.61mm)
<b>ORDER #:</b> 8808	Engine to Hydro Pump Belt. Fits 61"cut "O" turn models. Raw edge. *Aramid fiber.	<b>SUGG LIST:</b> <b>\$19.45</b> 1/2" (12.70mm)x 63" (1600.2mm)

<b>ORDER #:</b> 8809	Engine to Center Spindle Belt. Fits new style 48" cut models. Engine to center spindle for gear drive units. Wrap molded. *Aramid fiber.	<b>SUGG LIST:</b> <b>\$25.22</b> 21/32" (16.67mm)x 67-3/4" (1720.85mm)
<b>ORDER #:</b> 8803	Deck Belt. Fits new style 48" deck, Hydro mowers. Wrap molded. *Aramid fiber.	<b>SUGG LIST:</b> <b>\$24.23</b> 21/32" (16.67mm)x 85-3/10" (2166.62mm)
<b>ORDER #:</b> 5823	Engine to Blade Belt. For 48" deck. Covered.	<b>SUGG LIST:</b> <b>\$38.05</b> 5/8" (15.88mm)x 93" (2362.2mm)
<b>ORDER #:</b> 14572	PTO Belt. Used on 48" and 52" SD decks.	<b>SUGG LIST:</b> <b>\$33.60</b> 5/8" (15.88mm)x 95-3/4" (2432.05mm)
<b>ORDER #:</b> 14569	Engine to Deck Belt. Fits 52" Zero Turn.	<b>SUGG LIST:</b> <b>\$35.17</b> 5/8" (15.88mm)x 97" (2463.8mm)
<b>ORDER #:</b> 11468	Engine to Deck Belt. Fits 61" ZTR rider. Laminated, aramid cord construction.	<b>SUGG LIST:</b> <b>\$32.90</b> 5/8" (15.88mm)x 101" (2565.4mm)
<b>ORDER #:</b> 14570	Deck Belt. Fits most 52" mowers.	<b>SUGG LIST:</b> <b>\$48.80</b> 5/8" (15.88mm)x 121" (3073.4mm)
<b>ORDER #:</b> 11853	Cutter Deck Belt.	<b>SUGG LIST:</b> <b>\$38.95</b> 5/8" (15.88mm)x 132-3/4" (3371.85mm)

## BUNTON

<b>ORDER #:</b> 5238	Variable Speed Belt. Cogged. For 36", 48" & 52" decks.	<b>SUGG LIST:</b> <b>\$19.80</b> 5/8" (15.88mm)x 39-7/8" (1012.83mm)
<b>ORDER #:</b> 5241	Drive Belt. Fits 36" & 48" deck. Cogged.	<b>SUGG LIST:</b> <b>\$24.74</b> 5/8" (15.88mm)x 44-1/8" (1120.78mm)
<b>ORDER #:</b> 5237	Blade to Blade Belt. For 36" deck. Covered.	<b>SUGG LIST:</b> <b>\$15.16</b> 1/2" (12.70mm)x 49-7/8" (1266.83mm)

# COMET

<b>ORDER #:</b> 13048	Torque Convert Belt.	<b>SUGG LIST:</b> <b>\$27.55</b> 3/4" (19.05mm)x 27-23/64" (694.93mm)
<b>ORDER #:</b> 8487	Torque Convert Belt. Fits our 04-8382 Torq-A-Verter. Cogged.	<b>SUGG LIST:</b> <b>\$24.15</b> 3/4" (19.05mm)x 27-3/8" (695.33mm)
<b>ORDER #:</b> 13241	Torque Convert Belt.	<b>SUGG LIST:</b> <b>\$27.55</b> 5/8" (15.88mm)x 27-13/32" (696.12mm)
<b>ORDER #:</b> 13053	Torque Convert Belt.	<b>SUGG LIST:</b> <b>\$27.55</b> 3/4" (19.05mm)x 28-21/64" (719.53mm)
<b>ORDER #:</b> 9346	Torque Converter Belt. Used on serveral Go Karts that have a Max-Torque LTD torque converter.	<b>SUGG LIST:</b> <b>\$37.80</b> 11/16" (17.46mm)x 29-1/16" (738.19mm)
<b>ORDER #:</b> 10052	Torque Convert Belt. Belt for Torque Converter. Fits Manco, Carter Brothers and many other. Go-Carts.	<b>SUGG LIST:</b> <b>\$24.15</b> 3/4" (19.05mm)x 29-9/32" (743.74mm)
<b>ORDER #:</b> 13054	Torque Convert Belt.	<b>SUGG LIST:</b> <b>\$27.55</b> 3/4" (19.05mm)x 29-9/32" (743.74mm)
<b>ORDER #:</b> 9792	Torque Converter Belt. Used on serveral Go Karts that have a Max-Torque LTD torque converter.	<b>SUGG LIST:</b> <b>\$32.80</b> 11/16" (17.46mm)x 29-3/8" (746.13mm)
<b>ORDER #:</b> 13047	Torque Convert Belt.	<b>SUGG LIST:</b> <b>\$27.55</b> 3/4" (19.05mm)x 30-1/4" (768.35mm)
<b>ORDER #:</b> 13243	Torque Convert Belt.	<b>SUGG LIST:</b> <b>\$37.10</b> 3/4" (19.05mm)x 30-1/4" (768.35mm)
<b>ORDER #:</b> 13050	Torque Convert Belt.	<b>SUGG LIST:</b> <b>\$27.55</b> 3/4" (19.05mm)x 31-15/64" (793.35mm)

<b>ORDER #:</b> 13242	Torque Convert Belt. Also fits Bristers rear mount.	<b>SUGG LIST:</b> <b>\$27.55</b> 3/4" (19.05mm)x 31-15/64" (793.35mm)
<b>ORDER #:</b> 13627	Torque Converter Belt. Fits Manco 2433. Aramid cord construction.	<b>SUGG LIST:</b> <b>\$37.10</b> 7/8" (22.23mm)x 31-29/32" (810.42mm)
<b>ORDER #:</b> 13052	Torque Convert Belt. Also replaces G776 Belt S20 884-95F, fits Carter Bros.	<b>SUGG LIST:</b> <b>\$27.55</b> 3/4" (19.05mm)x 32-13/64" (817.96mm)
<b>ORDER #:</b> 13592	Drive Belt. Fits Manco 6814 & 40-80 for Comet 40/44 series torque Converter. Raw edge, cog, aramid cord construction.	<b>SUGG LIST:</b> <b>\$37.10</b> 7/8" (22.23mm)x 32-29/32" (835.82mm)
<b>ORDER #:</b> 13088	Torque Convert Belt.	<b>SUGG LIST:</b> <b>\$27.55</b> 3/4" (19.05mm)x 33-3/16" (842.9498mm)
<b>ORDER #:</b> 13059	Torque Convert Belt. Fits 340 series clutches.	<b>SUGG LIST:</b> <b>\$27.55</b> 3/4" (19.05mm)x 33-25/32" (858.04mm)
<b>ORDER #:</b> 13057	Torque Convert Belt. Carter Bros. G721.	<b>SUGG LIST:</b> <b>\$37.10</b> 7/8" (22.23mm)x 33-7/8" (860.43mm)
<b>ORDER #:</b> 13058	Torque Convert Belt. Fits 340 series clutches.	<b>SUGG LIST:</b> <b>\$27.55</b> 3/4" (19.05mm)x 35-9/64" (892.57mm)

## CUB CADET

<b>ORDER #:</b> 10563	V Belt. Fits 1000 series, 38" decks. Wrapped molded, aramid cord construction.	<b>SUGG LIST:</b> <b>\$19.78</b> 1/2" (12.70mm)x 60-1/2" (1536.70mm)
<b>ORDER #:</b> 10901	PTO Belt. Fits 3000 series. Matched set of 2 belts. Sold as set. Aramid, double cover.	<b>SUGG LIST:</b> <b>\$45.44</b> 1/2" (12.70mm)x 37-5/8" (955.68mm)
<b>ORDER #:</b> 12850	Transmission PTO Belt. Fits models M48-M72. Aramid cord clutching cover, (white).	<b>SUGG LIST:</b> <b>\$36.95</b> 1/2" (12.70mm)x 51-13/64" (1300.56mm)

<b>ORDER #:</b> 10783	Deck Belt. Fits 42" decks.. Wrapped molded, aramid cord construction.	<b>SUGG LIST:</b> <b>\$23.80</b> 1/2" (12.70mm)x 60" (1524mm)
<b>ORDER #:</b> 10782	Deck Belt. Fits 2000 series, model 190-142, 42" deck A62 spindle. Wrapped molded, aramid cord construction.	<b>SUGG LIST:</b> <b>\$28.58</b> 1/2" (12.70mm)x 62" (1574.8mm)
<b>ORDER #:</b> 10781	Spindle Drive Belt. Fits model 190-331, 38", manual PTO mower decks. Wrapped molded, aramid cord construction.	<b>SUGG LIST:</b> <b>\$23.61</b> 1" (25.4mm)x 63" (1600.2mm)
<b>ORDER #:</b> 10784	Deck Belt. Fits 42" decks.. Wrapped molded, aramid cord construction.	<b>SUGG LIST:</b> <b>\$27.49</b> 1/2" (12.70mm)x 67" (1701.8mm)
<b>ORDER #:</b> 11840	PTO Belt. Fits 600 series riding mowers. Aramid Cord, Double wrapped clutching cover.	<b>SUGG LIST:</b> <b>\$50.87</b> 5/8" (15.88mm)x 68-1/4" (1733.55mm)
<b>ORDER #:</b> 11846	Blade Drive Belt. Fits most 2005-2006 38" riding mowers. Aramid, double cover	<b>SUGG LIST:</b> <b>\$32.71</b> 1/2" (12.70mm)x 77-3/4" (1974.85mm)
<b>ORDER #:</b> 11849	Blade Drive Belt. Fits 1500 series riding mowers, with 46" deck. Drive belt fits LT1000 series. Aramid, double cover.	<b>SUGG LIST:</b> <b>\$30.20</b> 1/2" (12.70mm)x 79-1/4" (2012.95mm)
<b>ORDER #:</b> 10830	PTO Deck Drive Belt. Fits 38", 42", & 48" cut on models 70, 86, 123 & 169. Wrapped polyester cord construction.	<b>SUGG LIST:</b> <b>\$42.22</b> 1/2" (12.70mm)x 81-1/2" (2070.10mm)
<b>ORDER #:</b> 12708	Deck Belt. General purpose, aramid cord construction.	<b>SUGG LIST:</b> <b>\$38.35</b> 1/2" (12.70mm)x 83-13/32" (2118.52mm)
<b>ORDER #:</b> 12873	PTO V-Belt. Fits Craftsman Revolution tractor model 247.28933. Also fits. Cub Cadet i series zero turn tractors. MTD model 17AK9TKR099. Raw edge belt.	<b>SUGG LIST:</b> <b>\$32.93</b> 1/2" (12.70mm)x 89-1/4" (2266.95mm)
<b>ORDER #:</b> 12051	Blade Drive Belt. Fits 2000 series with 46" deck & 2000 series with 48" deck. Aramid, double cover.	<b>SUGG LIST:</b> <b>\$27.22</b> 1/2" (12.70mm)x 103" (2616.2mm)
<b>ORDER #:</b> 11850	Deck Drive Belt. Fits 1500 series lawn tractors with 38" deck. Aramid, double clutching cover.	<b>SUGG LIST:</b> <b>\$33.20</b> 1/2" (12.70mm)x 105" (2667mm)

<b>ORDER #:</b> 11820	Deck Drive Belt. Fits 44" deck, 2500 series models.	<b>SUGG LIST:</b> <b>\$40.41</b> 5/8" (15.88mm)x 110-29/32" (2817.02mm)
<b>ORDER #:</b> 11997	Deck Drive Belt. Fits 38" & 42" decks on Cub Cadet 2000 series. Wrapped molded general purpose, polyester cord construction, double cover.	<b>SUGG LIST:</b> <b>\$29.49</b> 5/8" (15.88mm)x 112-1/2" (2857.50mm)
<b>ORDER #:</b> 11843	Deck Drive Belt. Fits 46" deck LT1045 & LT1046 models.	<b>SUGG LIST:</b> <b>\$28.78</b> 1/2" (12.70mm)x 118-1/4" (3003.55mm)
<b>ORDER #:</b> 12769	Deck Belt. Fits LT1045 & LT1046. General purpose, aramid cord construction.	<b>SUGG LIST:</b> <b>\$41.14</b> 1/2" (12.70mm)x 122" (3098.8mm)
<b>ORDER #:</b> 12609	Deck Belt. Fits new 46" deck, model L1046, LT1045 & LT1046. Wrapped molded, aramid cord construction, double cover clutching, (color white).	<b>SUGG LIST:</b> <b>\$31.80</b> 1/2" (12.70mm)x 122-1/2" (3111.50mm)
<b>ORDER #:</b> 11847	Blade Drive Belt. Fits LT1050 50" riding mowers. Aramid, double clutching cover.	<b>SUGG LIST:</b> <b>\$59.98</b> 5/8" (15.88mm)x 133-45/64" (3396.06mm)
<b>ORDER #:</b> 11844	Deck Drive Belt. Fits 50" deck models. Aramid, double cover, clutching belt.	<b>SUGG LIST:</b> <b>\$39.07</b> 1/2" (12.70mm)x 134" (3403.6mm)
<b>ORDER #:</b> 12768	Deck Belt. RTZ54. General purpose, aramid cord construction.	<b>SUGG LIST:</b> <b>\$55.98</b> 5/8" (15.88mm)x 143" (3632.2mm)

## DIXIE CHOPPER

<b>ORDER #:</b> 10023	Engine to Transmission Belt. (B38). Raw edge, Polyester cord construction.	<b>SUGG LIST:</b> <b>\$12.19</b> 21/32" (16.67mm)x 40-29/32" (1039.02mm)
<b>ORDER #:</b> 10024	Engine to Transmission Belt. (B40). Raw edge, Polyester cord construction.	<b>SUGG LIST:</b> <b>\$23.34</b> 21/32" (16.67mm)x 42-13/16" (1087.44mm)
<b>ORDER #:</b> 10025	Engine to Transmission Belt. (B41). Raw edge, Polyester cord construction.	<b>SUGG LIST:</b> <b>\$20.19</b> 21/32" (16.67mm)x 43-13/16" (1112.84mm)

<b>ORDER #:</b> 10026	Engine to Transmission Belt. (B42). Raw edge, Polyester cord construction.	<b>SUGG LIST:</b> <b>\$15.40</b> 21/32" (16.67mm)x 44-13/16" (1138.24mm)
<b>ORDER #:</b> 12239	Engine to Transmission Belt. (B44). Fits 74" Xcaliber model.	<b>SUGG LIST:</b> <b>\$17.71</b> 21/32" (16.67mm)x 47" (1193.8mm)
<b>ORDER #:</b> 11223	Pump to Engine Belt. (B57). Fits models LT36 & 44. Raw edge, laminated, polyester cord construction.	<b>SUGG LIST:</b> <b>\$26.20</b> 5/8" (15.88mm)x 59-29/32" (1521.62mm)
<b>ORDER #:</b> 13366	Engine -Transmission V-Belt. Fits Iron Eagle 2350 model. Raw edge belt.	<b>SUGG LIST:</b> <b>\$19.19</b> 1/2" (12.70mm)x 64-1/2" (1638.30mm)
<b>ORDER #:</b> 11503	Engine to Transmission Belt. (B64). Fits 2006 series LT2000-50D, LT2500-50D & LT2700-60D. Raw edge, Laminated, polyester cord construction.	<b>SUGG LIST:</b> <b>\$19.68</b> 21/32" (16.67mm)x 66-29/32" (1699.42mm)
<b>ORDER #:</b> 10027	Engine to Deck Belt. (B78). Raw edge, Polyester cord construction.	<b>SUGG LIST:</b> <b>\$35.27</b> 21/32" (16.67mm)x 80-29/32" (2055.02mm)
<b>ORDER #:</b> 10029	Deck Belt. 2006 (B80). Fits 34",50" & 60" cut models. Raw edge, Polyester cord construction.	<b>SUGG LIST:</b> <b>\$29.98</b> 21/32" (16.67mm)x 82-29/32" (2105.82mm)
<b>ORDER #:</b> 10030	Engine Belt. (B81). Raw edge, Polyester cord construction.	<b>SUGG LIST:</b> <b>\$26.46</b> 21/32" (16.67mm)x 83-13/16" (2128.84mm)
<b>ORDER #:</b> 10031	Engine to Deck Belt. (B82). Raw edge, Polyester cord construction.	<b>SUGG LIST:</b> <b>\$42.98</b> 21/32" (16.67mm)x 84-13/16" (2154.24mm)
<b>ORDER #:</b> 10814	Engine to Deck Drive Belt. (B84). Raw edge, polyester cord construction.	<b>SUGG LIST:</b> <b>\$35.47</b> 5/8" (15.88mm)x 86-29/32" (2207.42mm)
<b>ORDER #:</b> 10032	Engine to Deck Belt. (B85). Raw edge, Polyester cord construction.	<b>SUGG LIST:</b> <b>\$29.49</b> 21/32" (16.67mm)x 87-13/16" (2230.44mm)
<b>ORDER #:</b> 12751	Engine to Deck Belt. (B87). (Super II B87). Fits 72" models. Raw edge, laminated, aramid cord construction.	<b>SUGG LIST:</b> <b>\$29.72</b> 5/8" (15.88mm)x 89" (2260.6mm)

<b>ORDER #:</b> 11502	Engine to Deck Belt. (B88). Fits 2006 models X2703-60, XG2703-60, XWF2700-60, XFG2700-60, SP2800-60, XT3300-060, LP3000-60, XXG2703-72 & XT3300-72. Raw edge, Laminated, polyester cord construction.	<b>SUGG LIST:</b> <b>\$26.50</b> 21/32" (16.67mm)x 90-29/32" (2309.02mm)
<b>ORDER #:</b> 12983	Engine to Deck Belt. Fits Extreme 3372. Raw Edge Belt.	<b>SUGG LIST:</b> <b>\$29.12</b> 5/8" (15.88mm)x 91" (2311.4mm)
<b>ORDER #:</b> 10035	Deck Belt. A89. Raw edge, Polyester cord construction.	<b>SUGG LIST:</b> <b>\$31.21</b> 1/2" (12.70mm)x 91-5/16" (2319.34mm)
<b>ORDER #:</b> 11225	Engine to Deck Belt. (B92). Fits models LT44. Raw edge, laminated, polyester cord construction.	<b>SUGG LIST:</b> <b>\$38.82</b> 5/8" (15.88mm)x 94-29/32" (2410.62mm)
<b>ORDER #:</b> 11226	Deck Belt. (B94). Fits models LT44. Raw edge, laminated, polyester cord construction.	<b>SUGG LIST:</b> <b>\$31.77</b> 5/8" (15.88mm)x 96-29/32" (2461.42mm)
<b>ORDER #:</b> 13219	Engine to Deck Drive Belt.	<b>SUGG LIST:</b> <b>\$37.65</b> 5/8" (15.88mm)x 100" (2540mm)
<b>ORDER #:</b> 12442	Deck Belt. (B98). Fits 66" Xcaliber model.	<b>SUGG LIST:</b> <b>\$38.96</b> 5/8" (15.88mm)x 101" (2565.4mm)
<b>ORDER #:</b> 12238	Engine to Deck Belt. (B99). Fits 74" Xcaliber model.	<b>SUGG LIST:</b> <b>\$39.78</b> 21/32" (16.67mm)x 102" (2590.8mm)
<b>ORDER #:</b> 13456	Deck Belt. (B100). Fits Iron Eagle. Belt- Engine Deck 44" 60" decks. Raw edge belt.	<b>SUGG LIST:</b> <b>\$40.59</b> 5/8" (15.88mm)x 102-7/8" (2613.03mm)
<b>ORDER #:</b> 10036	Deck Belt. (B103). Raw edge, Polyester cord construction.	<b>SUGG LIST:</b> <b>\$50.05</b> 21/32" (16.67mm)x 105-13/16" (2687.64mm)
<b>ORDER #:</b> 10033	Deck Belt. (B112). Raw edge, Polyester cord construction.	<b>SUGG LIST:</b> <b>\$36.74</b> 21/32" (16.67mm)x 114-13/16" (2916.24mm)
<b>ORDER #:</b> 10011	Deck Belt. (B128). Fits 60" Mowers. Raw edge, Polyester cord construction.	<b>SUGG LIST:</b> <b>\$40.50</b> 21/32" (16.67mm)x 130-13/16" (3322.64mm)

<b>ORDER #:</b> 10034	Deck Belt. (B130). Raw edge, Polyester cord construction.	<b>SUGG LIST:</b> <b>\$56.32</b> 21/32" (16.67mm)x 132-13/16" (3373.44mm)
<b>ORDER #:</b> 12443	Deck Belt. (B144). Fits 66" Xcaliber model.	<b>SUGG LIST:</b> <b>\$62.16</b> 5/8" (15.88mm)x 147" (3733.8mm)
<b>ORDER #:</b> 10815	Mule Drive Belt. (C158). Fits 72" cut with Yanmar diesel engines Polyester cord construction.	<b>SUGG LIST:</b> <b>\$131.07</b> 7/8" (22.23mm)x 162-1/8" (4117.98mm)
<b>ORDER #:</b> 12452	Engine to Deck Belt. (B160). Fits 72" models. Raw edge, laminated, aramid cord construction.	<b>SUGG LIST:</b> <b>\$68.38</b> 21/32" (16.67mm)x 162-51/64" (4135.04mm)
<b>ORDER #:</b> 10010	Deck Belt. (B162). Fits 72" Mowers. Raw edge, Polyester cord construction.	<b>SUGG LIST:</b> <b>\$51.87</b> 21/32" (16.67mm)x 164-13/16" (4186.24mm)

## DIXON

<b>ORDER #:</b> 8509	Drive Belt. Fits 42" & 50" deck, models 501, 503 & 542. Covered.	<b>SUGG LIST:</b> <b>\$32.71</b> 5/8" (15.88mm)x 78" (1981.2mm)
----------------------	--	---

## EXMARK

<b>ORDER #:</b> 10256	Pump Drive Belt. Fits Lazer ZXP. Poly groove belt.	<b>SUGG LIST:</b> <b>\$13.12</b> 45/64" (17.86mm)x 25" (635mm)
<b>ORDER #:</b> 12405	Deck Belt. Neoprene, Aramid cord construction, double-cover, clutching.	<b>SUGG LIST:</b> <b>\$24.07</b> 5/8" (15.88mm)x 36-5/64" (916.38mm)
<b>ORDER #:</b> 10167	Blower Belt. Polyester cord construction. Fits 44" mowers.	<b>SUGG LIST:</b> <b>\$16.18</b> 1/2" (12.70mm)x 37-3/4" (958.85mm)

<b>ORDER #:</b> 13254	Drive V-Belt. Fits Metro HP & Turf Tracer Blade Clutch. Aramid cord construction, double cover, clutching, (white color).	<b>SUGG LIST:</b> <b>\$18.16</b> 5/8" (15.88mm)x 38" (965.2mm)
<b>ORDER #:</b> 10039	Blower Belt. Polyester cord construction. Fits 48" mowers.	<b>SUGG LIST:</b> <b>\$17.90</b> 1/2" (12.70mm)x 38-1/2" (977.90mm)
<b>ORDER #:</b> 10717	Blower Belt. Wrapped-molded, general purpose, polyester cord construction.	<b>SUGG LIST:</b> <b>\$15.92</b> 1/2" (12.70mm)x 39-13/32" (1000.92mm)
<b>ORDER #:</b> 8812	Engine to Gear Box Belt. Fits Exmark 32", 36", 48" & 52" metro units. Raw edge, *Aramid fiber.	<b>SUGG LIST:</b> <b>\$16.78</b> 1/2" (12.70mm)x 39-5/8" (1006.48mm)
<b>ORDER #:</b> 10716	Blower Belt. Wrapped-molded, general purpose, polyester cord construction.	<b>SUGG LIST:</b> <b>\$17.34</b> 1/2" (12.70mm)x 40-13/32" (1026.32mm)
<b>ORDER #:</b> 5865	Wheel Drive Belt. For 32" decks, 5 speed transmission 10000 series and higher. Cogged.	<b>SUGG LIST:</b> <b>\$23.57</b> 5/8" (15.88mm)x 44-7/8" (1139.83mm)
<b>ORDER #:</b> 9257	Wheel Drive Belt. Double "A" section, top width 1-1/8. Fits 36", 48" & 52" cut mowers. Raw edge. *Aramid fiber.	<b>SUGG LIST:</b> <b>\$62.71</b> 1-1/8" (28.58mm)x 48-13/16" (1239.84mm)
<b>ORDER #:</b> 13108	Drive Belt. Fits 32" Metro walkbehind. Cogged, raw edge, polyester cord construction.	<b>SUGG LIST:</b> <b>\$35.82</b> 5/8" (15.88mm)x 48-53/64" (1240.23mm)
<b>ORDER #:</b> 10887	Pump Drive Belt. Fits Turf Tracer & Viking units. Raw edge, laminated, aramid cord construction.	<b>SUGG LIST:</b> <b>\$18.43</b> 1/2" (12.70mm)x 50-1/2" (1282.70mm)
<b>ORDER #:</b> 10253	Pump Drive Belt. Fits 52" Lazer HP.	<b>SUGG LIST:</b> <b>\$16.50</b> 1/2" (12.70mm)x 51-3/8" (1304.93mm)
<b>ORDER #:</b> 8092	Blade to Blade Belt. Fits 5 speed and variable speed with 36" decks. Raw Edge.	<b>SUGG LIST:</b> <b>\$22.84</b> 5/8" (15.88mm)x 51-29/32" (1318.42mm)
<b>ORDER #:</b> 10252	Pump Drive Belt. Fits 44" & 48" Lazer ZHP. Raw edge, cogged.	<b>SUGG LIST:</b> <b>\$22.43</b> 1/2" (12.70mm)x 52-1/4" (1327.15mm)

<b>ORDER #:</b> 9863	Pump Drive Belt. Fits Exmark Lazer mowers. 5 Rib, general purpose, polyester cord construction.	<b>SUGG LIST:</b> <b>\$18.98</b> 5/8" (15.88mm)x 57-13/64" (1452.96mm)
<b>ORDER #:</b> 10257	Pump Drive Belt. Fits Lazer Z. 8 rib.	<b>SUGG LIST:</b> <b>\$18.34</b> 3/4" (19.05mm)x 58" (1473.2mm)
<b>ORDER #:</b> 10884	Pump Drive Belt. Fits Turf Tracer. Raw edge, laminated, aramid cord construction.	<b>SUGG LIST:</b> <b>\$20.00</b> 1/2" (12.70mm)x 58" (1473.2mm)
<b>ORDER #:</b> 14810	Drive Belt. Fits TimeCutter models ZS3200, ZS3200S, ZS4200, SS3200, SS4200, SS4260, MX4260. Raw edge, cogged polyester cord construction.	<b>SUGG LIST:</b> <b>\$17.96</b> 1/2" (12.70mm)x 58" (1473.2mm)
<b>ORDER #:</b> 12799	Pump Belt. Raw edge, laminated, aramid cord construction.	<b>SUGG LIST:</b> <b>\$24.60</b> 45/64" (17.86mm)x 68-51/64" (1747.44mm)
<b>ORDER #:</b> 10255	Pump Drive Belt. Fits Lazer ZXP.	<b>SUGG LIST:</b> <b>\$29.85</b> 17/32" (13.49mm)x 70-3/4" (1797.05mm)
<b>ORDER #:</b> 12426	Pump Drive Belt. Fits models Exmark Quest & Toro Titan. Aramid cord, construction, double cover, clutching, (brown).	<b>SUGG LIST:</b> <b>\$22.43</b> 1/2" (12.70mm)x 75-25/64" (1914.92mm)
<b>ORDER #:</b> 13110	Engine to Blade Belt. Fits 32" Metro walk behind. Wrapped molded, aramid cord construction, double cover, (white).	<b>SUGG LIST:</b> <b>\$38.85</b> 5/8" (15.88mm)x 80-61/64" (2056.21mm)
<b>ORDER #:</b> 10885	Drive Belt. Fits 52" & 60" Turf Tracer serial numbers 84,000 and above. Wrapped, aramid cord construction.	<b>SUGG LIST:</b> <b>\$29.71</b> 5/8" (15.88mm)x 81-1/4" (2063.75mm)
<b>ORDER #:</b> 8091	Engine to Blade Belt. "B" Section Belt, fits 5 speed and variable speed with 48" decks. Raw Edge.	<b>SUGG LIST:</b> <b>\$36.85</b> 5/8" (15.88mm)x 82-11/32" (2091.53mm)
<b>ORDER #:</b> 13109	Engine to Blade Belt. Fits 36" Metro walkbehind. Wrapped molded, aramid cord construction, double cover, (white).	<b>SUGG LIST:</b> <b>\$39.75</b> 5/8" (15.88mm)x 82-39/64" (2098.28mm)
<b>ORDER #:</b> 14638	Deck Belt. Fits 52" Turf Tracer Hydro Wide area walk mowers. Wrapped molded, Aramid cord construction, double cover, (white).	<b>SUGG LIST:</b> <b>\$30.41</b> 5/8" (15.88mm)x 83-3/4" (2127.25mm)

<b>ORDER #:</b> 8805	Engine to Blade Belt. Fits Exmark 48" cut metro units. Raw edge. *Aramid fiber.	<b>SUGG LIST:</b> <b>\$52.32</b> 5/8" (15.88mm)x 87-15/16" (2233.61mm)
<b>ORDER #:</b> 5867	Blade Drive Belt. For 36" front cut mowers, 14000 series and higher. Covered.	<b>SUGG LIST:</b> <b>\$45.61</b> 5/8" (15.88mm)x 88-4/5" (2255.52mm)
<b>ORDER #:</b> 8370	Engine to Blade Belt. For 48" deck models. *Aramid fiber. Raw Edge.	<b>SUGG LIST:</b> <b>\$58.00</b> 5/8" (15.88mm)x 94" (2387.6mm)
<b>ORDER #:</b> 12256	Deck Drive Belt. Fits Turf Tracer & Turf Ranger models. Raw edge laminated aramid cord construction.	<b>SUGG LIST:</b> <b>\$33.17</b> 1/2" (12.70mm)x 101-1/4" (2571.75mm)
<b>ORDER #:</b> 11504	Deck Drive Belt. Fits 36" Turf Ranger mid range units.	<b>SUGG LIST:</b> <b>\$58.73</b> 5/8" (15.88mm)x 103-7/8" (2638.43mm)
<b>ORDER #:</b> 9014	Drive Belt. Fits 52" & 60" deck, Lazer models. Wrap molded. *Aramid fiber.	<b>SUGG LIST:</b> <b>\$51.39</b> 5/8" (15.88mm)x 111-11/25" (2830.58mm)
<b>ORDER #:</b> 10886	Blade Drive Belt. Fits 60" deck Turf Tracer. Raw edge, laminated, aramid cord construction.	<b>SUGG LIST:</b> <b>\$48.77</b> 1/2" (12.70mm)x 112-1/2" (2857.50mm)
<b>ORDER #:</b> 13454	Drive V-Belt. Fits main deck model Metro 48". Wrapped-molded, aramid cord construction, double cover, clutching, (salt/pepper color).	<b>SUGG LIST:</b> <b>\$43.03</b> 5/8" (15.88mm)x 115-9/32" (2928.14mm)
<b>ORDER #:</b> 12237	Mule Drive Belt. Fits 60" & 72" Lazer Z mule drive. Wrapped molded, laminated aramid cord construction.	<b>SUGG LIST:</b> <b>\$53.76</b> 5/8" (15.88mm)x 116-1/8" (2949.58mm)
<b>ORDER #:</b> 12783	Deck Belt. Fits Lazer Z XS, 66" deck. Raw edge, laminated, aramid cord construction.	<b>SUGG LIST:</b> <b>\$55.58</b> 5/8" (15.88mm)x 118-3/4" (3016.25mm)
<b>ORDER #:</b> 10254	Mule Drive Belt. Fits Lazer XP.	<b>SUGG LIST:</b> <b>\$40.59</b> 17/32" (13.49mm)x 120-5/16" (3055.94mm)
<b>ORDER #:</b> 13255	Drive V-Belt. Fits male drive diesel units. Aramid cord construction, double cover, clutching, white color.	<b>SUGG LIST:</b> <b>\$59.64</b> 5/8" (15.88mm)x 123" (3124.2mm)

<b>ORDER #:</b> 9862	Blade Drive Belt. Fits 52" Lazer Z. Raw Edge, *Aramid fiber.	<b>SUGG LIST:</b> <b>\$48.64</b> 5/8" (15.88mm)x 128-13/16" (3271.8375mm)
<b>ORDER #:</b> 10038	Deck Belt. *Aramid fiber. Fits 60" deck Lazer Z.	<b>SUGG LIST:</b> <b>\$44.64</b> 1/2" (12.70mm)x 134-1/4" (3409.95mm)
<b>ORDER #:</b> 10037	Blade Belt. *Aramid fiber. Fits 48" Turf Tracer units.	<b>SUGG LIST:</b> <b>\$73.22</b> 5/8" (15.88mm)x 136-41/64" (3470.67mm)
<b>ORDER #:</b> 10251	Blade Drive Belt. Fits 52" Turf Tracer and 48" Lazer HP.	<b>SUGG LIST:</b> <b>\$76.71</b> 5/8" (15.88mm)x 143-5/32" (3636.17mm)
<b>ORDER #:</b> 12425	Blade Drive Belt. Fits models Exmark Quest & Toro Titan. Aramid cord, construction, double cover, clutching, (white).	<b>SUGG LIST:</b> <b>\$34.47</b> 1/2" (12.70mm)x 146-7/64" (3711.18mm)
<b>ORDER #:</b> 9016	Blade Belt. Fits 60" deck, Lazer models. Raw edge. *Aramid fiber.	<b>SUGG LIST:</b> <b>\$61.60</b> 5/8" (15.88mm)x 146-3/16" (3713.16mm)
<b>ORDER #:</b> 10040	Mule Drive Belt. *Aramid fiber. Fits Lazer Z	<b>SUGG LIST:</b> <b>\$78.67</b> 21/32" (16.67mm)x 154" (3911.6mm)
<b>ORDER #:</b> 14209	Deck Belt. Fits 48" decks. Wrapped molded, Aramid cord construction, double cover, clutching, (brown).	<b>SUGG LIST:</b> <b>\$81.53</b> 5/8" (15.88mm)x 154-7/8" (3933.83mm)
<b>ORDER #:</b> 13256	Drive V-Belt. Fits 66" Lazer Z-XS deck drive. Aramid cord construction, laminated.	<b>SUGG LIST:</b> <b>\$62.89</b> 5/8" (15.88mm)x 158" (4013.2mm)
<b>ORDER #:</b> 10041	Deck Belt. Deck belt for 72" Lazer Z units. *Aramid fiber.	<b>SUGG LIST:</b> <b>\$115.36</b> 5/8" (15.88mm)x 169-15/32" (4304.51mm)
<b>ORDER #:</b> 14217	Deck Belt. Fits Lazer Z 48" decks. Wrapped molded, Aramid cord construction, double cover, clutching, (brown).	<b>SUGG LIST:</b> <b>\$77.96</b> 5/8" (15.88mm)x 175-3/4" (4464.05mm)
<b>ORDER #:</b> 14165	Deck Belt. Fits Lazer Z 52" decks. Wrapped molded, Aramid cord construction, double cover, clutching, (brown).	<b>SUGG LIST:</b> <b>\$105.30</b> 5/8" (15.88mm)x 186" (4724.4mm)

- ORDER #:** 14167 Deck Belt. Fits Lazer Z 60" decks. Wrapped molded, Aramid cord construction, double cover, clutching, (brown). **SUGG LIST:** **\$108.65**  
5/8" (15.88mm)x  
198-3/4" (5048.25mm)
- ORDER #:** 14366 Deck Belt. Fits 72" Lazer Z & Lazer Z AS, air cooled engines (serial number 790,000 and higher). Covered belt, (brown). **SUGG LIST:** **\$125.21**  
5/8" (15.88mm)x  
219-1/4" (5568.95mm)

## FERRIS

- ORDER #:** 14765 Pump Drive Belt. Fits IS series Zero Turn Riders. V-Band raw edge, laminated, polyester cord construction. **SUGG LIST:** **\$65.30**  
1/2" (12.70mm)x  
64-19/25" (1644.904mm)
- ORDER #:** 14763 Pump Drive Belt. Fits IS and Pro Cut Z-series. Neoprene, polyester cord construction. **SUGG LIST:** **\$90.30**  
4 Ribx  
106-1/2" (2705.1mm)
- ORDER #:** 14848 Deck Belt. Fits models IS1500 with 44" deck & ZT4000. Wrapped molded, SBR, Aramid cord construction, double cover, clutching, (brown). **SUGG LIST:** **\$60.20**  
5/8" (15.88mm)x  
141-3/4" (3600.45mm)
- ORDER #:** 14639 Deck Belt. Fits 48" deck. Wrapped molded Aramid cord construction, double cover, clutching, (brown). **SUGG LIST:** **\$98.30**  
5/8" (15.88mm)x  
147-2/5" (3743.96mm)
- ORDER #:** 14762 Deck Belt. Fits 52" deck. Aramid cord construction, double cover, clutching, (brown). **SUGG LIST:** **\$84.20**  
5/8" (15.88mm)x  
150-9/10" (3832.86mm)
- ORDER #:** 14766 Deck Belt. Used on IS1500Z series. Wrapped molded, SBR, Aramid cord construction, double cover, clutching, (brown). **SUGG LIST:** **\$104.20**  
5/8" (15.88mm)x  
160-3/5" (4079.24mm)
- ORDER #:** 14764 Deck Belt. Fits 61" deck. Wrapped molded, SBR, Aramid cord construction, double cover, clutching, (brown). **SUGG LIST:** **\$117.05**  
5/8" (15.88mm)x  
172-3/4" (4387.85mm)

# GRASSHOPPER

<b>ORDER #:</b> 8733	Drive Belt. Fits P.T.O. Belt models 720, 721, 721D & 725. "A" section, Cog V-belt, raw edge and Dacron cord construction.	<b>SUGG LIST:</b> <b>\$14.25</b> 1/2" (12.70mm)x 36" (914.4mm)
<b>ORDER #:</b> 12094	Hydro Belt. Fits Kohler mid mount mowers. Models 218, 220, 223, 225, 227. Raw edge, aramid cord construction.	<b>SUGG LIST:</b> <b>\$28.20</b> 5/8" (15.88mm)x 60-1/2" (1536.70mm)
<b>ORDER #:</b> 8731	Drive Belt. Fits 52" decks. Cog V-belt, raw edge. *Aramid fiber.	<b>SUGG LIST:</b> <b>\$33.50</b> 5/8" (15.88mm)x 64" (1625.6mm)
<b>ORDER #:</b> 10743	V Belt. Fits 61" mid mount deck, diesel engine. Wrapped molded polyester cord construction,	<b>SUGG LIST:</b> <b>\$29.40</b> 5/8" (15.88mm)x 65-3/4" (1670.05mm)
<b>ORDER #:</b> 12098	Mule Drive Belt. Fits 428D diesel. Wrapped, aramid cord construction.	<b>SUGG LIST:</b> <b>\$48.20</b> 5/8" (15.88mm)x 110-1/2" (2806.70mm)
<b>ORDER #:</b> 12095	Deck Belt. Fits M148 deck (2003 and earlier). Wrapped, aramid cord construction.	<b>SUGG LIST:</b> <b>\$51.40</b> 5/8" (15.88mm)x 112-1/2" (2857.50mm)
<b>ORDER #:</b> 12096	Deck Belt. Fits M152 deck. Wrapped, aramid cord construction.	<b>SUGG LIST:</b> <b>\$48.60</b> 5/8" (15.88mm)x 120-1/2" (3060.70mm)
<b>ORDER #:</b> 12097	Deck Belt. Fits 3452 & 9852. Wrapped, aramid cord construction.	<b>SUGG LIST:</b> <b>\$53.55</b> 5/8" (15.88mm)x 135-1/2" (3441.70mm)
<b>ORDER #:</b> 10744	Mule Drive & Deck Belt. Fits 61" mid mount deck, diesel engine. Wrapped molded, aramid cord construction, clutching cover.	<b>SUGG LIST:</b> <b>\$52.95</b> 5/8" (15.88mm)x 137-1/2" (3492.50mm)
<b>ORDER #:</b> 12099	Deck Belt. Fits 3461 & 9861. Wrapped, aramid cord construction.	<b>SUGG LIST:</b> <b>\$55.55</b> 5/8" (15.88mm)x 141" (3581.4mm)
<b>ORDER #:</b> 14363	Deck Belt. Fits 124-52 Mule Drive for 329B & 335B. Wrapped-molded, aramid cord construction, double cover, clutching, (brown).	<b>SUGG LIST:</b> <b>\$56.70</b> 5/8" (15.88mm)x 145-1/2" (3695.70mm)

<b>ORDER #:</b> 10745	Mule Drive Belt. Fits 61" mid mount deck, diesel engine. Wrapped molded, aramid cord construction, clutching cover.	<b>SUGG LIST:</b> <b>\$57.25</b> 5/8" (15.88mm)x 147-1/2" (3746.50mm)
<b>ORDER #:</b> 12108	Mule Drive Belt. Fits 322D diesel. Wrapped, aramid cord construction.	<b>SUGG LIST:</b> <b>\$56.50</b> 5/8" (15.88mm)x 150" (3810mm)
<b>ORDER #:</b> 12109	Mule Drive Belt. Fits 329 models. Wrapped, aramid cord construction.	<b>SUGG LIST:</b> <b>\$64.40</b> 5/8" (15.88mm)x 151-1/2" (3848.10mm)
<b>ORDER #:</b> 12100	Mule Drive Belt. Fits 428 diesel. Wrapped, aramid cord construction.	<b>SUGG LIST:</b> <b>\$57.60</b> 5/8" (15.88mm)x 153-1/2" (3898.90mm)
<b>ORDER #:</b> 12106	Deck Belt. Fits M172 deck and Mule Drive Belt 321D & 325 models (2005 and earlier). Wrapped, aramid cord construction.	<b>SUGG LIST:</b> <b>\$65.20</b> 5/8" (15.88mm)x 158" (4013.2mm)
<b>ORDER #:</b> 12107	Mule Drive Belt. Fits 428D diesel. Wrapped, aramid cord construction.	<b>SUGG LIST:</b> <b>\$62.90</b> 5/8" (15.88mm)x 163" (4140.2mm)

## GRAVELY

<b>ORDER #:</b> 8760	PTO Belt. Fits Pro Master 100, 200 & Pro 200, 300. Also fits 36", 38", 40" & 50" cut models. V-belt, raw edge, cogged. *Aramid fiber.	<b>SUGG LIST:</b> <b>\$26.30</b> 1/2" (12.70mm)x 37-5/8" (955.68mm)
<b>ORDER #:</b> 8717	Drive Belt. Fits 2 per wheel on all Pro series walk behind. "A" section, Cogged. *Aramid fiber. This belt sold in matching pairs.	<b>SUGG LIST:</b> <b>\$39.95</b> 1/2" (12.70mm)x 46-5/8" (1184.28mm)
<b>ORDER #:</b> 8711	Wheel Drive Belt. For Pro 150 series. Cogged. This belt sold in matching pairs.	<b>SUGG LIST:</b> <b>\$35.95</b> 1/2" (12.70mm)x 52-13/16" (1341.44mm)
<b>ORDER #:</b> 7837	Cutter Deck Belt. "A" Section Belt, cogged. For 50" deck.	<b>SUGG LIST:</b> <b>\$43.70</b> 1/2" (12.70mm)x 127-7/64" (3228.58mm)

# GREAT DANE

<b>ORDER #:</b> 10893	Engine Pump Belt. Fits Super Surfer. Raw edge, aramid cord construction.	<b>SUGG LIST:</b> <b>\$25.31</b> 1/2" (12.70mm)x 68-1/2" (1739.90mm)
<b>ORDER #:</b> 10628	Hydro Pump Drive Belt. Fits Chariot. Raw edge, laminated, aramid cord construction.	<b>SUGG LIST:</b> <b>\$25.10</b> 1/2" (12.70mm)x 76" (1930.4mm)
<b>ORDER #:</b> 10623	Blade Drive Belt. Fits 48" Surfer. Raw edge, laminated, aramid cord construction.	<b>SUGG LIST:</b> <b>\$42.35</b> 5/8" (15.88mm)x 77-1/2" (1968.50mm)
<b>ORDER #:</b> 10624	Blade Drive Belt. Fits 52" Surfer. Raw edge, laminated, aramid cord construction.	<b>SUGG LIST:</b> <b>\$44.14</b> 5/8" (15.88mm)x 82-1/4" (2089.15mm)
<b>ORDER #:</b> 10625	Blade Drive Belt. Fits 61" Surfer. Raw edge, laminated, aramid cord construction.	<b>SUGG LIST:</b> <b>\$49.45</b> 5/8" (15.88mm)x 88-3/4" (2254.25mm)
<b>ORDER #:</b> 10894	Engine Blade Belt. Fits 48" Super Surfer. Raw edge, aramid cord construction.	<b>SUGG LIST:</b> <b>\$54.46</b> 5/8" (15.88mm)x 108" (2743.2mm)
<b>ORDER #:</b> 10627	Blade Drive Belt. Fits Chariot. Raw edge, laminated, aramid cord construction.	<b>SUGG LIST:</b> <b>\$59.97</b> 5/8" (15.88mm)x 108-1/4" (2749.55mm)
<b>ORDER #:</b> 10629	Blade to Blade Belt. Fits 52" Chariot. Wrap molded, general purpose, aramid cord construction. Double "V" or Hex or BB Belt.	<b>SUGG LIST:</b> <b>\$70.81</b> 5/8" (15.88mm)x 120-19/64" (3055.54mm)
<b>ORDER #:</b> 10626	Blade to Blade Belt. Fits 61" Chariot. Wrap molded, general purpose, aramid cord construction.	<b>SUGG LIST:</b> <b>\$76.31</b> 5/8" (15.88mm)x 134-5/16" (3411.54mm)

# HUSTLER

<b>ORDER #:</b> 12688	Pump Belt. Fits Tristar walk behind mowers. Aramid cord construction.	<b>SUGG LIST:</b> <b>\$16.50</b> 1/2" (12.70mm)x 47-3/8" (1203.33mm)
<b>ORDER #:</b> 12693	Deck Belt. Fits Tristar 36" walk behind mowers. Aramid cord construction.	<b>SUGG LIST:</b> <b>\$16.79</b> 1/2" (12.70mm)x 50-1/8" (1273.18mm)
<b>ORDER #:</b> 14939	Hydro Pump Drive Belt. Fits Raptor models. Cogged, polyester cord construction.	<b>SUGG LIST:</b> <b>\$14.10</b> 1/2" (12.70mm)x 50-3/4" (1289.05mm)
<b>ORDER #:</b> 10848	Hydro Pump Belt. Fits Mini Z and Super Z 52" deck. Wrapped, aramid cord construction.	<b>SUGG LIST:</b> <b>\$15.76</b> 1/2" (12.70mm)x 57-3/8" (1457.33mm)
<b>ORDER #:</b> 10844	Hydro Pump Belt. Fits Z and Super Z. Wrapped, polyester cord construction.	<b>SUGG LIST:</b> <b>\$19.31</b> 1/2" (12.70mm)x 62-1/4" (1581.15mm)
<b>ORDER #:</b> 12413	Hydro Pump Belt. Fits MINI FASTTRAK models. General purpose, Aramid cord construction, double cover.	<b>SUGG LIST:</b> <b>\$16.75</b> 1/2" (12.70mm)x 63" (1600.2mm)
<b>ORDER #:</b> 12414	Hydro Pump Belt. Fits MINI Z 36" & 42" units. Laminated, Aramid cord construction.	<b>SUGG LIST:</b> <b>\$17.00</b> 1/2" (12.70mm)x 64" (1625.6mm)
<b>ORDER #:</b> 12695	Deck Drive Belt. Fits TriStar 48" deck drive walk behind mower. Aramid cord construction.	<b>SUGG LIST:</b> <b>\$26.50</b> 5/8" (15.88mm)x 65-3/32" (1653.38mm)
<b>ORDER #:</b> 12694	Deck Drive Belt. Fits TriStar 36" deck drive walk behind mower. Aramid cord construction.	<b>SUGG LIST:</b> <b>\$19.25</b> 1/2" (12.70mm)x 66-3/8" (1685.93mm)
<b>ORDER #:</b> 14026	Pump Belt. Wrapped molded Aramid cord construction, double cover, (black) semi-dry.	<b>SUGG LIST:</b> <b>\$17.78</b> 1/2" (12.70mm)x 67-6/25" (1707.9mm)
<b>ORDER #:</b> 14037	V Belt. Cogged belt, aramid cord construction.	<b>SUGG LIST:</b> <b>\$23.26</b> 5/8" (15.88mm)x 69-4/11" (1761.85mm)

<b>ORDER #:</b> 12689	Pump Belt. Fits FasTrak Hydro pump belt for 48" & 54" decks. Aramid cord construction.	<b>SUGG LIST:</b> <b>\$21.95</b> 1/2" (12.70mm)x 70-1/2" (1790.70mm)
<b>ORDER #:</b> 10851	Hydro Pump Belt. Fits hydraulic for Fast Track models. Wrapped, aramid cord construction.	<b>SUGG LIST:</b> <b>\$24.24</b> 1/2" (12.70mm)x 73-3/4" (1873.25mm)
<b>ORDER #:</b> 12417	Hydro Pump Belt. Fits 48" deck Trimstar Hydro walk behind models. General purpose, Aramid cord construction, double cover, clutching.	<b>SUGG LIST:</b> <b>\$25.08</b> 5/8" (15.88mm)x 86-19/64" (2191.94mm)
<b>ORDER #:</b> 12318	Deck Belt. General purpose, Aramid cord construction, double cover, clutching.	<b>SUGG LIST:</b> <b>\$36.35</b> 1/2" (12.70mm)x 114" (2895.6mm)
<b>ORDER #:</b> 12415	Deck Belt. Fits 36" deck Mini Fastrack models. General purpose, Aramid cord construction, double cover, clutching.	<b>SUGG LIST:</b> <b>\$27.83</b> 1/2" (12.70mm)x 116" (2946.4mm)
<b>ORDER #:</b> 12416	Deck Belt. Fits 42" deck Mini Fastrack models. General purpose, Aramid cord construction, double cover, clutching.	<b>SUGG LIST:</b> <b>\$29.00</b> 1/2" (12.70mm)x 127-19/64" (3233.34mm)
<b>ORDER #:</b> 12264	Deck Belt. Fits 42" Mini Z model 928200. General purpose, Aramid cord construction, double cover, clutching.	<b>SUGG LIST:</b> <b>\$43.96</b> 1/2" (12.70mm)x 132" (3352.8mm)
<b>ORDER #:</b> 10861	Deck Belt. Fits 44" Fast Track models. Wrapped, aramid cord construction.	<b>SUGG LIST:</b> <b>\$45.03</b> 5/8" (15.88mm)x 138-1/4" (3511.55mm)
<b>ORDER #:</b> 10850	Deck Belt. Fits Mini Z and Super Z 44" & 48" deck. Wrapped, aramid cord construction.	<b>SUGG LIST:</b> <b>\$44.68</b> 5/8" (15.88mm)x 140" (3556mm)
<b>ORDER #:</b> 12319	Deck Belt. General purpose, Aramid cord construction, double cover, clutching.	<b>SUGG LIST:</b> <b>\$38.00</b> 5/8" (15.88mm)x 143" (3632.2mm)
<b>ORDER #:</b> 10852	Deck Belt. Fits 52" Fast Track models. Wrapped, aramid cord construction.	<b>SUGG LIST:</b> <b>\$45.61</b> 5/8" (15.88mm)x 145-3/8" (3692.53mm)
<b>ORDER #:</b> 10849	Deck Belt. Fits Mini Z and Super Z 52" deck. Wrapped, aramid cord construction.	<b>SUGG LIST:</b> <b>\$46.89</b> 5/8" (15.88mm)x 148-1/2" (3771.90mm)

<b>ORDER #:</b> 12320	Deck Belt. General purpose, Aramid cord construction, double cover, clutching.	<b>SUGG LIST:</b> <b>\$55.55</b> 5/8" (15.88mm)x 152" (3860.8mm)
<b>ORDER #:</b> 12321	Deck Belt. General purpose, Aramid cord construction, double cover, clutching.	<b>SUGG LIST:</b> <b>\$55.85</b> 5/8" (15.88mm)x 160-13/64" (4069.16mm)
<b>ORDER #:</b> 10847	Deck Belt. Fits Z and Super Z 52" deck. Wrapped, aramid cord construction.	<b>SUGG LIST:</b> <b>\$56.49</b> 5/8" (15.88mm)x 165-1/2" (4203.70mm)
<b>ORDER #:</b> 14000	Deck Belt. Fits 60" X-One models. Wrapped molded, Aramid cord construction, double cover, clutching, (white).	<b>SUGG LIST:</b> <b>\$64.95</b> 5/8" (15.88mm)x 171-1/4" (4349.75mm)
<b>ORDER #:</b> 12322	Deck Belt. General purpose, Aramid cord construction, double cover, clutching.	<b>SUGG LIST:</b> <b>\$60.00</b> 5/8" (15.88mm)x 176-51/64" (4490.64mm)
<b>ORDER #:</b> 14062	V Belt. Fits 60" cut Super Z models. Wrapped molded Aramid cord construction, double cover, clutching.	<b>SUGG LIST:</b> <b>\$63.33</b> 5/8" (15.88mm)x 178-1/4" (4527.55mm)
<b>ORDER #:</b> 10845	Deck Belt. Fits Z and Super Z 60" deck. Wrapped, aramid cord construction.	<b>SUGG LIST:</b> <b>\$61.13</b> 5/8" (15.88mm)x 180" (4572mm)
<b>ORDER #:</b> 12323	Deck Belt. General purpose, Aramid cord construction, double cover, clutching.	<b>SUGG LIST:</b> <b>\$58.50</b> 5/8" (15.88mm)x 184-51/64" (4693.84mm)
<b>ORDER #:</b> 14061	V Belt. Fits 66" cut Super Z models. Wrapped molded Aramid cord construction, double cover, clutching.	<b>SUGG LIST:</b> <b>\$65.55</b> 5/8" (15.88mm)x 191-3/20" (4855.21mm)
<b>ORDER #:</b> 10846	Deck Belt. Fits Z and Super Z 72" deck. Wrapped, aramid cord construction.	<b>SUGG LIST:</b> <b>\$59.76</b> 5/8" (15.88mm)x 195" (4953mm)
<b>ORDER #:</b> 12690	Deck Belt. Fits rear discharge Z and Super Z, 54" decks. Aramid cord construction.	<b>SUGG LIST:</b> <b>\$85.95</b> 5/8" (15.88mm)x 204-1/2" (5194.30mm)
<b>ORDER #:</b> 12691	Deck Belt. Fits rear discharge Z and Super Z, 60" decks. Aramid cord construction.	<b>SUGG LIST:</b> <b>\$84.75</b> 5/8" (15.88mm)x 213-1/2" (5422.90mm)

- ORDER #:** 14786 V Belt. Aramid cord construction, double cover, clutching, (brown). **SUGG LIST:** **\$85.97**  
5/8" (15.88mm)x  
216" (5486.4mm)
- ORDER #:** 12692 Deck Belt. Fits rear discharge Super Z only. Aramid cord construction. **SUGG LIST:** **\$109.95**  
5/8" (15.88mm)x  
228-23/32" (5809.46mm)

# JOHN DEERE

- ORDER #:** 14237 Pump Drive Belt. Fits models 737, 757, 777 & 797 Z-Trak. 6 rib, "K" section Aramid cord, (Fabric back). **SUGG LIST:** **\$32.66**  
7/8" (22.23mm)x  
31-1/2" (800.10mm)
- ORDER #:** 10486 V Belt. Fits walk behind mower models JS63, Also fits Sabre mower model M23 & Scotts mower model SP6213. Raw edge polyester cord construction, laminated. **SUGG LIST:** **\$8.93**  
3/8" (9.53mm)x  
34-3/4" (882.65mm)
- ORDER #:** 11811 Drive Belt. Fits 21" JD25-45 series & Snapper Easy Line series self propelled mowers. Also replaces Snapper 7100058. Wrapped molded, general purpose, aramid cord construction, double cover. **SUGG LIST:** **\$14.66**  
3/8" (9.53mm)x  
37-3/4" (958.85mm)
- ORDER #:** 10485 V Belt. Fits walkbehind mower models JS60, JS61, JS63, JS63C, JS63E. Also fits Sabre mower model M21 & Scotts mower model SP6211. Raw edge polyester cord construction, laminated. **SUGG LIST:** **\$8.25**  
3/8" (9.53mm)x  
39-1/16" (992.19mm)
- ORDER #:** 13157 Hydro Drive Belt. Fits EZ-Trak model Z425, Z445, Z465. Wrapped molded Polyester cord construction, double cover. **SUGG LIST:** **\$27.21**  
1/2" (12.70mm)x  
42-1/4" (1073.15mm)
- ORDER #:** 11027 Secondary Drive Belt. Fits models GS25, GS30, GS45 & GS75 commercial walk behind mowers. Fits HD45 and HD75 Hydrostatic commercial walk behind mowers. Fits G15 commercial walk-behind mowers. Synchronous timing belt. **SUGG LIST:** **\$29.52**  
1" (25.4mm)x  
50-25/64" (1279.92mm)
- ORDER #:** 11028 Drive Belt. Fits models GS25, GS30, GS45 & GS75 commercial walk behind mowers. Fits G15 commercial walk-behind mowers. Raw edge, cogged, aramid cord construction. **SUGG LIST:** **\$26.52**  
5/8" (15.88mm)x  
50-1/2" (1282.70mm)
- ORDER #:** 10388 Primary Belt. Fits models 1842GV, 1848GV, 1948GV. Raw edge polyester cord construction, laminated **SUGG LIST:** **\$24.86**  
9/16" (14.29mm)x  
64-1/4" (1631.95mm)
- ORDER #:** 12078 Primary Deck Belt. Fits models LX255, LX277, LX279, LX288, LX277AWS, LX280, LX289 all using 42C 48" and 52" decks. Also fits GT242, GT262, GT275 with 48" decks. Also fits GT225, GT235, GT255, GX255, 325, 335, 345. Raw edge double cog, polyester cord construction. **SUGG LIST:** **\$36.82**  
5/8" (15.88mm)x  
64-1/2" (1638.30mm)

<b>ORDER #:</b> 11026	Primary Belt. Fits models GS25, GS30, GS45 & GS75 commercial walk behind mowers with 36" deck. Also fits G15 commercial walk behind mowers. Wrapped molded, general purpose, aramid cord construction, clutching cover.	<b>SUGG LIST:</b> <b>\$33.50</b> 1/2" (12.70mm)x 70-5/8" (1793.88mm)
<b>ORDER #:</b> 12898	Drive Belt. Aramid clutching cover, (white).	<b>SUGG LIST:</b> <b>\$27.48</b> 1/2" (12.70mm)x 86-25/64" (2194.32mm)
<b>ORDER #:</b> 10434	Drive Belt. Fits models 1542G, 15.542G, 1743GS, 17.542HS. Wrapped fiberglass cord construction.	<b>SUGG LIST:</b> <b>\$21.63</b> 17/32" (13.49mm)x 88-5/8" (2251.08mm)
<b>ORDER #:</b> 14382	Drive Belt. Fits models GX255, GT225, GT235, GT245. Aramid cord construction, double cover, clutching, (brown).	<b>SUGG LIST:</b> <b>\$45.16</b> 5/8" (15.88mm)x 89-4/5" (2280.92mm)
<b>ORDER #:</b> 10435	Drive Belt. Fits model L-100 14.542GS. Wrapped polyester cord construction.	<b>SUGG LIST:</b> <b>\$38.71</b> 17/32" (13.49mm)x 91-13/16" (2332.04mm)
<b>ORDER #:</b> 13035	Traction Drive V-Belt. Fits LT150-LT190 & X300-X320 riders. Wrapped molded, polyester cord construction, double cover.	<b>SUGG LIST:</b> <b>\$31.64</b> 1/2" (12.70mm)x 91-7/8" (2333.63mm)
<b>ORDER #:</b> 10749	Deck Belt. Fits 38" black mower deck on model STX38 lawn tractor. Serial number 210001 & higher. Raw edge aramid cord construction.	<b>SUGG LIST:</b> <b>\$37.82</b> 1/2" (12.70mm)x 95-3/4" (2432.05mm)
<b>ORDER #:</b> 13036	Traction Drive V-Belt. Fits LT150. Wrapped molded, Aramid cord construction, double cover, clutching, (color white).	<b>SUGG LIST:</b> <b>\$34.68</b> 1/2" (12.70mm)x 97" (2463.8mm)
<b>ORDER #:</b> 10751	Drive Belt. Fits models LX176, LX178, LX186 & LX188. Wrapped molded, aramid cord construction, clutching cover.	<b>SUGG LIST:</b> <b>\$32.82</b> 1/2" (12.70mm)x 102" (2590.8mm)
<b>ORDER #:</b> 10436	Deck Belt. Fits model 14.542GS. Wrapped polyester cord construction.	<b>SUGG LIST:</b> <b>\$36.98</b> 1/2" (12.70mm)x 103-3/4" (2635.25mm)
<b>ORDER #:</b> 10750	Drive Belt. Fits model STX38. Wrapped molded, aramid cord construction, clutching cover.	<b>SUGG LIST:</b> <b>\$31.64</b> 1/2" (12.70mm)x 105" (2667mm)
<b>ORDER #:</b> 12373	DeckDrive Belt. Fits LT133, LT155, LT166 series 38" models. Wrapped molded, general purpose, aramid cord construction, double cover.	<b>SUGG LIST:</b> <b>\$36.35</b> 1/2" (12.70mm)x 114-1/2" (2908.30mm)

<b>ORDER #:</b> 12678	Drive Belt. Aramid cord construction, double cover, wrapped, clutching, (white).	<b>SUGG LIST:</b> <b>\$47.38</b> 1/2" (12.70mm)x 115-1/4" (2927.35mm)
<b>ORDER #:</b> 12759	PTO Engine to Deck Belt. Fits Z-Trak 737, 757, & 797, 60" & 72" decks. Aramid cord construction, double cover.	<b>SUGG LIST:</b> <b>\$56.11</b> 5/8" (15.88mm)x 117" (2971.8mm)
<b>ORDER #:</b> 13217	V Belt. Fits Sabre Lawn Tractors: 2254HV, 2354HV, 2554HV all 54" deck only. Scotts Lawn Tractors: GT2554, S2554 all with 54" deck only. John Deere Lawn Tractors: 325, 335, 345, 355D, G100, GT225, GT235, GT235E, GT245, GX325, GX335, GX345, GX355, LX255, LX266. Aramid cord, double cover, clutching.	<b>SUGG LIST:</b> <b>\$50.16</b> 5/8" (15.88mm)x 120" (3048mm)
<b>ORDER #:</b> 14390	Double V- Belt. Fits F110, F225, F735, 54" deck Homeowner Zero turn mowers. Aramid cord construction, laminated.	<b>SUGG LIST:</b> <b>\$103.11</b> 5/8" (15.88mm)x 128-3/4" (3270.25mm)
<b>ORDER #:</b> 12814	PTO Engine to Deck V-Belt. Fits Z-Trak 737, 757, 797, 54" decks. Wrapped molded, aramid cord construction, double cover, friction.	<b>SUGG LIST:</b> <b>\$60.77</b> 5/8" (15.88mm)x 131-1/2" (3340.10mm)
<b>ORDER #:</b> 10437	Drive Belt. Fits model L2048. Wrapped fiberglass cord construction.	<b>SUGG LIST:</b> <b>\$33.98</b> 17/32" (13.49mm)x 138-7/8" (3527.43mm)
<b>ORDER #:</b> 12461	PTO Drive Belt. Fits models 145 & 155C. Aramid cord construction, double cover.	<b>SUGG LIST:</b> <b>\$43.45</b> 1/2" (12.70mm)x 141-7/64" (3584.18mm)
<b>ORDER #:</b> 12760	Deck Belt. Fits Z-Trak 737, 757, & 797, 60" decks. Aramid cord construction, double cover.	<b>SUGG LIST:</b> <b>\$59.00</b> 5/8" (15.88mm)x 141-47/64" (3600.05mm)
<b>ORDER #:</b> 10630	V Belt. Fits model S2046, 46" cut Scotts. Wrapped molded, aramid cord construction, clutching cover.	<b>SUGG LIST:</b> <b>\$46.95</b> 1/2" (12.70mm)x 143-5/16" (3640.14mm)
<b>ORDER #:</b> 12559	Deck Belt. Fits 38" mower deck belt. Aramid cord construction, double cover.	<b>SUGG LIST:</b> <b>\$56.30</b> 1/2" (12.70mm)x 143-1/2" (3644.90mm)
<b>ORDER #:</b> 12560	Deck Belt. Fits 42" mower deck belt. Aramid cord construction, double cover.	<b>SUGG LIST:</b> <b>\$52.54</b> 1/2" (12.70mm)x 146-1/4" (3714.75mm)
<b>ORDER #:</b> 11024	Drive Belt. Fits models 717 front mount mowers, zero turns with 48" decks. Fits Great Dane Chariot/Chariot LX. Wrapped molded, laminated neoprene, aramid cord, clutch cover.	<b>SUGG LIST:</b> <b>\$67.11</b> 5/8" (15.88mm)x 150-13/64" (3815.16mm)

- ORDER #:** 13158 Deck V-Belt. Fits EZ-Trak model Z425, Z445, Z465. Raw edge Aramid cord construction. **SUGG LIST:** **\$66.46**  
1/2" (12.70mm)x  
152-1/4" (3867.15mm)
- ORDER #:** 11025 Drive Belt. Fits models 727 mini frame Z-trak, front mount mowers, zero turn with 54" decks. Fits Great Dane Chariot / Chariot LX 54" cut. Wrapped molded, laminated, neoprene, aramid cord, clutch cover. **SUGG LIST:** **\$72.84**  
5/8" (15.88mm)x  
157-9/32" (3994.94mm)
- ORDER #:** 14243 V Belt. Fits 54" deck models LA150, LA175, G110 & 190C. Wrapped molded, aramid cord construction, double cover, clutching, (brown). **SUGG LIST:** **\$54.98**  
5/8" (15.88mm)x  
161-13/32" (4099.72mm)

## MCCLANE

- ORDER #:** 8761 Engine Belt. Fits 1991-present, front throw reel mowers. Covered. **SUGG LIST:** **\$5.23**  
1/2" (12.70mm)x  
19.5" (494.92mm)
- ORDER #:** 8780 Drive Belt. Fits 21" self propelled rotary mower. Polyester cord construction. Covered. **SUGG LIST:** **\$8.98**  
1/2" (12.70mm)x  
24-1/2" (622.30mm)

## MTD

- ORDER #:** 13567 Snow Blower Auger V-Belt. Fits 300 series compact two-stage snow blowers 2004-up. Raw edge, cogged. **SUGG LIST:** **\$11.96**  
3/8" (9.53mm)x  
27" (685.8mm)
- ORDER #:** 14447 Snow Thrower Belt. Fits MTD two stage snow-throwers, 2005 and newer. Wrapped molded, polyester cord construction, single clutch cover, (brown). **SUGG LIST:** **\$16.64**  
3/8" (9.53mm)x  
29" (736.6mm)
- ORDER #:** 6950 Drive Belt. Fits 462R & 479R series self-propelled mowers. Covered. **SUGG LIST:** **\$17.25**  
3/8" (9.53mm)x  
30" (762mm)
- ORDER #:** 11137 Drive Belt. Fits self propelled walk behind mowers. **SUGG LIST:** **\$9.54**  
3/8" (9.53mm)x  
31-1/4" (793.75mm)

<b>ORDER #:</b> 13653	Transmission V-Belt. Transmission belt for self propelled walkbehind mower, front wheel drive, 2008 and after. 12AG & 12AV series. Polyester cord construction, wrapped molded, single cover.	<b>SUGG LIST:</b> <b>\$15.48</b> 3/8" (9.53mm)x 31-11/16" (804.86mm)
<b>ORDER #:</b> 10833	Variable Speed Belt. Fits models 660 thru 688. For 2001 and up.	<b>SUGG LIST:</b> <b>\$11.37</b> 5/8" (15.88mm)x 31-3/4" (806.5mm)
<b>ORDER #:</b> 14215	V-Belt. Fits 2010 - up Craftsman, Tractor Supply Huskee, Walmart Yard Man. Wrapped-molded, polyester cord construction, single cover, clutching brown.	<b>SUGG LIST:</b> <b>\$19.79</b> 5/8" (15.88mm)x 33-13/16" (858.84mm)
<b>ORDER #:</b> 13288	Snow Blower Drive Belt. Neoprene, aramid cord construction, single clutching, (salt-pepper color).	<b>SUGG LIST:</b> <b>\$19.98</b> 3/8" (9.53mm)x 34-13/32" (873.92mm)
<b>ORDER #:</b> 14118	Snowthrower Belt. Fits two stage snow thrower, 2005 newer. Raw edge, cogged, aramid cord construction.	<b>SUGG LIST:</b> <b>\$14.32</b> 1/2" (12.70mm)x 35" (889mm)
<b>ORDER #:</b> 10089	Snowthrower Belt. Fits snowthrower model 721. *Aramid fiber.	<b>SUGG LIST:</b> <b>\$17.98</b> 1/2" (12.70mm)x 35" (889mm)
<b>ORDER #:</b> 12429	Drive Belt. Fits Snow Thrower models from 1992-2002. Raw edge. Laminated, Aramid cord construction. Sold in Matching Pairs.	<b>SUGG LIST:</b> <b>\$27.95</b> 3/8" (9.53mm)x 35" (889mm)
<b>ORDER #:</b> 6906	Variable Speed Belt. Covered.	<b>SUGG LIST:</b> <b>\$27.25</b> 5/8" (15.88mm)x 35-1/4" (895.35mm)
<b>ORDER #:</b> 13232	V-Belt. Fits MTD models 400, 500, 550 series self propelled walk behind, 1998 and older, also fits 550 series edgers. Neoprene, polyester cord construction single cover, clutching, (white).	<b>SUGG LIST:</b> <b>\$11.21</b> 3/8" (9.53mm)x 35-5/8" (904.88mm)
<b>ORDER #:</b> 9480	V-Belt. General purpose, polyester cord construction. Covered.	<b>SUGG LIST:</b> <b>\$20.77</b> 5/8" (15.88mm)x 36-1/4" (920.75mm)
<b>ORDER #:</b> 11135	Drive Belt. Fits self propelled front wheel drive models 263, 264, 525, 528 & 529 mowers 2000 & after.	<b>SUGG LIST:</b> <b>\$10.88</b> 3/8" (9.53mm)x 38-5/32" (969.17mm)
<b>ORDER #:</b> 6907	Belt. 754-0240. *Aramid fiber. Covered.	<b>SUGG LIST:</b> <b>\$24.39</b> 5/8" (15.88mm)x 38-3/16" (969.96mm)

<b>ORDER #:</b> 9901	Engine Pulley to Drive Pulley Belt. Fits front wheel drive self-propelled rear discharge mowers. General purpose, polyester cord construction.	<b>SUGG LIST:</b> <b>\$18.20</b> 3/8" (9.53mm)x 39" (990.6mm)
<b>ORDER #:</b> 11132	V Belt. Fits rear wheel drive, rear discharge mowers 1997 & after. Models 959C, 979C, E979E & 999C.	<b>SUGG LIST:</b> <b>\$12.71</b> 3/8" (9.53mm)x 39-1/4" (996.95mm)
<b>ORDER #:</b> 11483	Secondary Drive Belt. Fits auto drive step thru frame Lawn & Garden Tractors	<b>SUGG LIST:</b> <b>\$21.80</b> 5/8" (15.88mm)x 41-1/2" (1054.10mm)
<b>ORDER #:</b> 6840	Variable Speed Belt. Fits 600 series variable speed unit to rear end. Also fits 38", 40" & 42" older units. Covered.	<b>SUGG LIST:</b> <b>\$24.36</b> 5/8" (15.88mm)x 44-7/32" (1123.16mm)
<b>ORDER #:</b> 9932	Drive Belt. Fits 800 series 2 speed garden tractors 1997 and after. General purpose, polyester cord construction.	<b>SUGG LIST:</b> <b>\$22.59</b> 5/8" (15.88mm)x 45" (1143mm)
<b>ORDER #:</b> 6908	Variable Speed Belt. 600 series. Fits 42" cut mowers. *Aramid fiber. Covered.	<b>SUGG LIST:</b> <b>\$26.35</b> 5/8" (15.88mm)x 48" (1219.2mm)
<b>ORDER #:</b> 9482	Variable Speed To Transmission Belt. Fits models 820 - 849. Wrap molded, *Aramid fiber, clutching cover. Covered.	<b>SUGG LIST:</b> <b>\$32.49</b> 7/8" (22.23mm)x 50" (1270mm)
<b>ORDER #:</b> 13551	Drive Belt. Wheel drive belt for MTD Pro G1336, 36" walk behind, Craftsman Model 247.889360. Cogged, Aramid cord construction.	<b>SUGG LIST:</b> <b>\$41.73</b> 1/2" (12.70mm)x 51-3/4" (1314.45mm)
<b>ORDER #:</b> 6839	Engine/Variable Speed Belt. Fits 600 series variable speed unit engines. Also fits 38", 40" & 42" older units. Covered.	<b>SUGG LIST:</b> <b>\$27.27</b> 5/8" (15.88mm)x 53" (1346.2mm)
<b>ORDER #:</b> 9570	Transmission Drive Belt. Fits 800 series 2-speed garden tractors, 1996 & prior. General purpose. *Aramid fiber. Clutching cover. Covered.	<b>SUGG LIST:</b> <b>\$36.85</b> 7/8" (22.23mm)x 53-1/4" (1352.55mm)
<b>ORDER #:</b> 12382	Drive Belt. Raw edge. Laminated, Aramid cord construction.	<b>SUGG LIST:</b> <b>\$24.83</b> 1/2" (12.70mm)x 57-45/64" (1465.66mm)
<b>ORDER #:</b> 9119	Deck Belt. Fits 600 series tractors. Wrap molded. *Aramid fiber. Clutching cover.	<b>SUGG LIST:</b> <b>\$34.92</b> 5/8" (15.88mm)x 60" (1524mm)

<b>ORDER #:</b> 11019	Engine to Deck Belt. Fits auto step through tractors 1999 and newer. Wrapped aramid cord clutching cover.	<b>SUGG LIST:</b> <b>\$30.89</b> 1/2" (12.70mm)x 60-1/16" (1525.59mm)
<b>ORDER #:</b> 6844	Engine to Deck Belt. Fits 46" cut lawn tractors 800 series. *Aramid fiber. Covered.	<b>SUGG LIST:</b> <b>\$34.65</b> 5/8" (15.88mm)x 64" (1625.6mm)
<b>ORDER #:</b> 10369	Deck Belt. Fits 42" step thru frame 2001 and after. Also fits Troy Bilt. Wrapped molded, general purpose aramid cord construction, clutching cover.	<b>SUGG LIST:</b> <b>\$31.80</b> 1" (25.4mm)x 67" (1701.8mm)
<b>ORDER #:</b> 6949	Blade to Blade Belt. Fits 32" cut "D" decks. Covered.	<b>SUGG LIST:</b> <b>\$34.42</b> 1/2" (12.70mm)x 67" (1701.8mm)
<b>ORDER #:</b> 10100	Engine to Deck Belt. Fits auto drive, step through frame 46" lawn and garden tractors 1999 & after with manual PTO. General purpose, polyester cord construction.	<b>SUGG LIST:</b> <b>\$37.47</b> 5/8" (15.88mm)x 67" (1701.8mm)
<b>ORDER #:</b> 10831	Variable Speed Belt. Raw edge, laminated, polyester cord construction.	<b>SUGG LIST:</b> <b>\$20.40</b> 5/8" (15.88mm)x 69-3/16" (1757.36mm)
<b>ORDER #:</b> 6842	Blade to Blade Belt. Fits 600 series lawn tractors with 38" side discharge, 805 series decks. Covered.	<b>SUGG LIST:</b> <b>\$34.29</b> 5/8" (15.88mm)x 69-9/32" (1759.74mm)
<b>ORDER #:</b> 14595	Drive Belt. Fits models 13AN77KS011 & 13AN77KS066, 38", 42" & 46" single speed Troy-Bilt and MTD riders.	<b>SUGG LIST:</b> <b>\$26.10</b> 5/8" (15.88mm)x 70-9/10 (1800.86mm)
<b>ORDER #:</b> 6841	Blade to Blade Belt. Fits 44" cut, side discharge, 935 series decks. Covered.	<b>SUGG LIST:</b> <b>\$21.14</b> 1/2" (12.70mm)x 74" (1879.6mm)
<b>ORDER #:</b> 6845	Blade to Blade Belt. 754-0371A. Fits Riders with 42" cut side discharge "G" decks. Covered. *Aramid fiber.	<b>SUGG LIST:</b> <b>\$49.33</b> 5/8" (15.88mm)x 74" (1879.6mm)
<b>ORDER #:</b> 9847	V-Belt. General purpose, polyester cord construction.	<b>SUGG LIST:</b> <b>\$35.98</b> 1/2" (12.70mm)x 76" (1930.4mm)
<b>ORDER #:</b> 9903	Transmission to Engine Belt. Fits 800 series hydrostatic garden tractors 1997 and after. General purpose, polyester cord construction.	<b>SUGG LIST:</b> <b>\$34.53</b> 1/2" (12.70mm)x 78-1/2" (1993.90mm)

<b>ORDER #:</b> 6843	Deck Drive Belt. Fits 820 thru 849 series tractors with 46" cut side discharge "H" decks. Covered.	<b>SUGG LIST:</b> <b>\$26.90</b> 1/2" (12.70mm)x 79-3/32" (2008.98mm)
<b>ORDER #:</b> 12770	V-Belt. Fits MTD models LTX Drive Belt. Polyester cord construction.	<b>SUGG LIST:</b> <b>\$23.37</b> 1/2" (12.70mm)x 79-19/64" (2014.14mm)
<b>ORDER #:</b> 9935	Deck Belt. Fits auto drive, step through frame 42" lawn and garden tractors 1999 & after. General purpose, polyester cord construction.	<b>SUGG LIST:</b> <b>\$27.04</b> 5/8" (15.88mm)x 83" (2108.2mm)
<b>ORDER #:</b> 13301	V-Belt. Fits MTD models LTX 52" decks. Polyester cord construction.	<b>SUGG LIST:</b> <b>\$25.44</b> 1/2" (12.70mm)x 84-7/64" (2136.38mm)
<b>ORDER #:</b> 6838	Engine/Transmission Belt. Fits 4 speed transaxle engines to transmission. Covered.	<b>SUGG LIST:</b> <b>\$30.53</b> 1/2" (12.70mm)x 85-7/32" (2164.56mm)
<b>ORDER #:</b> 10910	Motion Drive Belt. Fits 38", 40", 42" & 46" decks with Hydro transmission. 2000 and after. 1 ply polyester cord construction.	<b>SUGG LIST:</b> <b>\$18.95</b> 1/2" (12.70mm)x 89" (2260.6mm)
<b>ORDER #:</b> 9581	Deck Belt. Fits European rear discharge mowers. 2 Ply cover, double V, *Aramid fiber.	<b>SUGG LIST:</b> <b>\$55.80</b> 5/8" (15.88mm)x 89-29/32" (2283.62mm)
<b>ORDER #:</b> 11848	PTO to Spindle Belt. Fits 46" deck models. Also replaces Cub Cadet, Troybilt, Bolens Yard Machines, Husky, Yardman.	<b>SUGG LIST:</b> <b>\$27.25</b> 1/2" (12.70mm)x 90-1/4" (2292.35mm)
<b>ORDER #:</b> 11482	Primary Drive Belt. Fits auto drive step thru frame Lawn & Garden Tractors 1999 and newer.	<b>SUGG LIST:</b> <b>\$33.63</b> 5/8" (15.88mm)x 90-1/2" (2298.70mm)
<b>ORDER #:</b> 12489	Deck Belt. Fits 46" decks, Step-Thru frame lawn tractors. Aramid cord construction, double cover.	<b>SUGG LIST:</b> <b>\$25.43</b> 1/2" (12.70mm)x 91-13/32" (2321.72mm)
<b>ORDER #:</b> 6508	Motion Drive Belt. Fits 39", 40" and 42" cut. *Aramid fiber, with bare back cover. Covered.	<b>SUGG LIST:</b> <b>\$20.95</b> 1/2" (12.70mm)x 95" (2413mm)
<b>ORDER #:</b> 11660	Deck Drive Belt. Fits 42" 2005 and newer LT-5 design frames. Wrapped Molded general purpose, aramid cord construction, double clutching cover.	<b>SUGG LIST:</b> <b>\$33.63</b> 1/2" (12.70mm)x 96-1/2" (2451.10mm)

<b>ORDER #:</b> 10009	PTO Belt. Fits 42" deck with manual PTO, for 2000 and later units. *Aramid fiber.	<b>SUGG LIST:</b> <b>\$54.55</b> 5/8" (15.88mm)x 97" (2463.8mm)
<b>ORDER #:</b> 9120	Deck Belt. Fits 600 series tractors. Wrap molded, general purpose, polyester cord construction. Covered.	<b>SUGG LIST:</b> <b>\$33.79</b> 1/2" (12.70mm)x 99" (2514.6mm)
<b>ORDER #:</b> 10260	Deck Drive Belt. Fits auto drive step through Garden Tractors with 46" decks (1999 & older). *Aramid fiber, wrap molded, clutching cover.	<b>SUGG LIST:</b> <b>\$43.68</b> 5/8" (15.88mm)x 100" (2540mm)
<b>ORDER #:</b> 10261	Engine to Deck Belt. Fits auto drive step through Garden Tractors with 46" decks with Electric PTO. *Aramid fiber.	<b>SUGG LIST:</b> <b>\$48.45</b> 5/8" (15.88mm)x 100" (2540mm)
<b>ORDER #:</b> 12790	V-Belt. Fits MTD models LTX 46" Deck Belt. Polyester cord construction.	<b>SUGG LIST:</b> <b>\$33.27</b> 1/2" (12.70mm)x 103-1/4" (2622.55mm)
<b>ORDER #:</b> 12610	PTO Belt. Fits models L 1046, LT1045 & LT1046. Aramid cord construction, double cover.	<b>SUGG LIST:</b> <b>\$33.09</b> 5/8" (15.88mm)x 111-13/64" (2824.56mm)
<b>ORDER #:</b> 12077	Secondary Deck Belt. Fits 48" deck, LX & GT series models. Wrapped molded, general purpose, aramid cord construction, double cover. Also fits SCOTTS model S2048.	<b>SUGG LIST:</b> <b>\$44.18</b> 5/8" (15.88mm)x 111-3/8" (2828.93mm)
<b>ORDER #:</b> 9900	Deck Belt. Fits 50" deck 990 series garden tractors. General purpose, polyester cord construction.	<b>SUGG LIST:</b> <b>\$50.45</b> 1/2" (12.70mm)x 117" (2971.8mm)
<b>ORDER #:</b> 12667	Deck Drive Belt. Fits models LT1024, 50" decks. Aramid cord construction, double cover.	<b>SUGG LIST:</b> <b>\$43.00</b> 5/8" (15.88mm)x 131-7/64" (3330.18mm)
<b>ORDER #:</b> 11661	Deck Drive Belt. Fits 54" auto drive model with electric PTO. Wrapped Molded general purpose, aramid cord construction, double clutching cover.	<b>SUGG LIST:</b> <b>\$63.62</b> 5/8" (15.88mm)x 137-29/32" (3502.82mm)
<b>ORDER #:</b> 12791	V-Belt. 954-04240. Fits MTD models LTX 52" decks. Polyester cord construction.	<b>SUGG LIST:</b> <b>\$59.07</b> 1/2" (12.70mm)x 162-29/32" (4137.82mm)

# MURRAY

<b>ORDER #:</b> 11029	Primary Drive Belt. Wrapped, polyester cord construction.	<b>SUGG LIST:</b> <b>\$15.95</b> 25/32" (19.84mm)x 29-11/32" (745.33mm)
<b>ORDER #:</b> 7245	Drive Belt. Motor to transaxle belt. Fits 25" and 30" rear engine rider with transaxle. Models 25515B and 305351B. Covered.	<b>SUGG LIST:</b> <b>\$13.25</b> 1/2" (12.70mm)x 30-3/16" (766.76mm)
<b>ORDER #:</b> 11030	Secondary Drive Belt. Wrapped, polyester cord construction.	<b>SUGG LIST:</b> <b>\$16.95</b> 25/32" (19.84mm)x 34" (863.6mm)
<b>ORDER #:</b> 12462	Torque Converter Belt. Torque converter belt for Go-Karts. Aramid cord construction.	<b>SUGG LIST:</b> <b>\$34.95</b> 11/16" (17.46mm)x 34-37/64" (878.28mm)
<b>ORDER #:</b> 14228	Snowthrower Drive Belt. Fits 3 hp and 4.5 hp 20" snowthrowers. Aramid cord construction.	<b>SUGG LIST:</b> <b>\$17.75</b> 6 Ribx 34-33/50" (880.364mm)
<b>ORDER #:</b> 10042	Drive Belt. Fits Murray Go-Carts. *Aramid fiber.	<b>SUGG LIST:</b> <b>\$25.30</b> 3/4" (19.05mm)x 35-3/8" (898.53mm)
<b>ORDER #:</b> 8747	Motion Drive Belt. Fits Aerovac 21", 5-5.5 hp walk behind. V-belt, raw edge. *Aramid fiber.	<b>SUGG LIST:</b> <b>\$8.95</b> 1/4" (6.35mm)x 36-25/32" (934.24mm)
<b>ORDER #:</b> 14120	Snowthrower Belt. Fits Craftsman & Murray dual stage snow throwers & Snow Blizzard. Raw edge, Aramid cord.	<b>SUGG LIST:</b> <b>\$16.30</b> 1/2" (12.70mm)x 38-3/8" (974.73mm)
<b>ORDER #:</b> 10832	Motion Drive Belt. Fits 30" rear engine rider model 309304X8A. Wrapped, polyester cord construction.	<b>SUGG LIST:</b> <b>\$12.50</b> 1/2" (12.70mm)x 43-7/8" (1114.43mm)
<b>ORDER #:</b> 10913	Secondary Drive Belt. Wrapped, polyester cord construction.	<b>SUGG LIST:</b> <b>\$19.95</b> 25/32" (19.84mm)x 44-25/32" (1137.44mm)
<b>ORDER #:</b> 10911	Blade Drive Belt. Covered, general purpose polyester cord construction.	<b>SUGG LIST:</b> <b>\$15.95</b> 7/16" (11.11mm)x 45" (1143mm)

<b>ORDER #:</b> 8444	Blade to Blade Belt. V belt. Fits Murray & Ultra Lawn Tractors 18 hp, 46300 series, 46" cut models. Covered.	<b>SUGG LIST:</b> <b>\$12.10</b> 1/2" (12.70mm)x 47-1/10" (1196.34mm)
<b>ORDER #:</b> 9713	Secondary Blade Drive Belt. Fits 50" Murray riders. Polyester cord construction. Covered.	<b>SUGG LIST:</b> <b>\$12.50</b> 1/2" (12.70mm)x 52" (1320.8mm)
<b>ORDER #:</b> 6507	Blade Belt. Fits 30" cut. *Aramid fiber, with bare back cover. Covered.	<b>SUGG LIST:</b> <b>\$18.50</b> 1/2" (12.70mm)x 53-11/16" (1363.66mm)
<b>ORDER #:</b> 6876	Blade Belt. Fits 30" rear engine rider 8 hp. Also fits 36" cut front engine riders 8, 10 and 11 hp. Covered.	<b>SUGG LIST:</b> <b>\$17.05</b> 1/2" (12.70mm)x 54-15/16" (1395.41mm)
<b>ORDER #:</b> 6504	Blade Belt. Fits 39", 40" and 42" cut. *Aramid fiber, with bare back cover. Covered.	<b>SUGG LIST:</b> <b>\$24.95</b> 1/2" (12.70mm)x 62-1/10" (1577.34mm)
<b>ORDER #:</b> 10912	Drive Belt. Fits 42" & 46" decks. Wrapped belt, 2 ply polyester cord construction.	<b>SUGG LIST:</b> <b>\$20.95</b> 11/16" (17.46mm)x 67-1/2" (1714.50mm)
<b>ORDER #:</b> 13992	Snowthrower Drive Belt. Fits 2 stage snowthrower. Polyester cord construction.	<b>SUGG LIST:</b> <b>\$12.75</b> 3/8" (9.53mm)x 70-9/10 (1800.86mm)
<b>ORDER #:</b> 675	Deck Belt. 6 sided. Oil and heat resistant. Double V.	<b>SUGG LIST:</b> <b>\$16.95</b> 0x 73" (1854.2mm)
<b>ORDER #:</b> 7672	Blade Belt. Fits 46" cut 14-18 hp, 1990-1994 models. Covered.	<b>SUGG LIST:</b> <b>\$24.95</b> 1/2" (12.70mm)x 77-11/16" (1973.26mm)
<b>ORDER #:</b> 8443	Engine to Deck Belt. Fits Murray & Ultra Lawn Tractors 18 hp, 46300 series, 46" cut models. Covered.	<b>SUGG LIST:</b> <b>\$26.50</b> 1/2" (12.70mm)x 80-5/16" (2039.94mm)
<b>ORDER #:</b> 9481	Motion Drive Belt. Fits Murray riders. General purpose, polyester cord construction. Covered.	<b>SUGG LIST:</b> <b>\$17.95</b> 1/2" (12.70mm)x 81-3/4" (2076.45mm)
<b>ORDER #:</b> 4998	Blade Belt. Fits 36" deck with rear and side discharge Covered.	<b>SUGG LIST:</b> <b>\$22.95</b> 1/2" (12.70mm)x 82-3/32" (2085.18mm)

<b>ORDER #:</b> 6509	Blade Belt. Fits 38" cut, 12 hp. Glass cord construction with bare back cover. Covered.	<b>SUGG LIST:</b> <b>\$24.50</b> 1/2" (12.70mm)x 83-1/10" (2110.74mm)
<b>ORDER #:</b> 9712	V-Belt. Fits 38" Murray riders. Polyester cord construction. Covered.	<b>SUGG LIST:</b> <b>\$18.50</b> 1/2" (12.70mm)x 84" (2133.6mm)
<b>ORDER #:</b> 13541	Trans Drive V-Belt. Trans drive belt, dual spindle brake. Fits 7800000 model series riders. Double cover, Aramid cord construction.	<b>SUGG LIST:</b> <b>\$45.65</b> 1/2" (12.70mm)x 85-3/8" (2168.53mm)
<b>ORDER #:</b> 6904	Blade Belt. Fits 39", 40" and 42" cut. Covered.	<b>SUGG LIST:</b> <b>\$24.95</b> 1/2" (12.70mm)x 85-15/16" (2182.81mm)
<b>ORDER #:</b> 9994	Deck Belt. Fits 40", 42" & 43" deck lawn tractors. Polyester cord construction.	<b>SUGG LIST:</b> <b>\$19.75</b> 1/2" (12.70mm)x 86-1/4" (2190.75mm)
<b>ORDER #:</b> 9313	Primary Belt. Fits 46" cut mowers. *Aramid fiber, wrapped belt. Covered.	<b>SUGG LIST:</b> <b>\$21.75</b> 1/2" (12.70mm)x 87" (2209.8mm)
<b>ORDER #:</b> 9715	Primary Blade Drive Belt. Fits 46" Murray riders. *Aramid fiber. Covered.	<b>SUGG LIST:</b> <b>\$21.95</b> 1/2" (12.70mm)x 88-1/4" (2241.55mm)
<b>ORDER #:</b> 6502	Drive Belt. Fits 39", 40" and 42" decks. *Aramid fiber, with bare back cover. Covered.	<b>SUGG LIST:</b> <b>\$29.95</b> 1/2" (12.70mm)x 88-5/16" (2243.14mm)
<b>ORDER #:</b> 8972	V-Belt. Fits 42" Hydro tractor. *Aramid fiber, wrapped belt.	<b>SUGG LIST:</b> <b>\$19.95</b> 1/2" (12.70mm)x 89-1/2" (2273.30mm)
<b>ORDER #:</b> 6505	Drive Belt. Fits 39", 40" and 42" cut. Dacron cord construction with bare back cover.	<b>SUGG LIST:</b> <b>\$28.95</b> 1/2" (12.70mm)x 90-1/2" (2298.70mm)
<b>ORDER #:</b> 7673	Blade Belt. Fits 42" cut 12-18 hp, 1990-1994 models. Covered.	<b>SUGG LIST:</b> <b>\$28.50</b> 1/2" (12.70mm)x 91-1/4" (2317.75mm)
<b>ORDER #:</b> 9995	Drive Belt. Fits 38" deck lawn tractors. Polyester cord construction.	<b>SUGG LIST:</b> <b>\$16.15</b> 1/2" (12.70mm)x 97" (2463.8mm)

<b>ORDER #:</b> 11017	Deck Belt. Raw edge, laminated, aramid cord construction.	<b>SUGG LIST:</b> <b>\$35.40</b> 5/8" (15.88mm)x 97-2/3" (2480.73mm)
<b>ORDER #:</b> 6903	Blade Cross Drive Belt. Fits 42" cut 11, 14, 16 and 18 hp engines. Covered.	<b>SUGG LIST:</b> <b>\$41.95</b> 1/2" (12.70mm)x 99" (2514.6mm)
<b>ORDER #:</b> 8442	Motion Drive Belt. V belt. Fits Murray & Ultra Lawn Tractors 18 hp, 46300 series, 46" cut models. Covered.	<b>SUGG LIST:</b> <b>\$29.95</b> 1/2" (12.70mm)x 101-11/16" (2582.86mm)
<b>ORDER #:</b> 9714	Primary Blade Drive Belt. Fits 52" Murray riders. *Aramid fiber. Covered.	<b>SUGG LIST:</b> <b>\$36.25</b> 5/8" (15.88mm)x 109" (2768.6mm)

## NOMA

<b>ORDER #:</b> 6872	Cutter Deck Belt. Raw Edge.	<b>SUGG LIST:</b> <b>\$33.33</b> 5/8" (15.88mm)x 73-3/4" (1873.25mm)
<b>ORDER #:</b> 7128	Deck Drive Belt. Fits Noma Eagle Star. Raw Edge.	<b>SUGG LIST:</b> <b>\$30.75</b> 5/8" (15.88mm)x 77-3/4" (1974.85mm)
<b>ORDER #:</b> 6871	Cutter Deck Belt. Raw Edge.	<b>SUGG LIST:</b> <b>\$36.69</b> 5/8" (15.88mm)x 80" (2032mm)
<b>ORDER #:</b> 6896	Belt.	<b>SUGG LIST:</b> <b>\$15.25</b> 1/2" (12.70mm)x 82" (2082.8mm)
<b>ORDER #:</b> 6970	Cutter Deck Belt. *Aramid fiber. Raw Edge.	<b>SUGG LIST:</b> <b>\$21.07</b> 1/2" (12.70mm)x 82" (2082.8mm)
<b>ORDER #:</b> 6898	Belt. Covered.	<b>SUGG LIST:</b> <b>\$17.78</b> 1/2" (12.70mm)x 90" (2286mm)

# SCAG

<b>ORDER #:</b> 7791	Transmission Drive Belt. Used on Scag 32", 36", 48", 52" and 61" cut mid size mowers. Raw Edge. *Aramid fiber.	<b>SUGG LIST:</b> <b>\$20.57</b> 1/2" (12.70mm)x 39-13/16" (1011.24mm)
<b>ORDER #:</b> 10317	Deck Drive Belt. Fits Turf Tiger 52" & 61" decks. *Aramid Cord, cogged, raw edge belt.	<b>SUGG LIST:</b> <b>\$28.27</b> 5/8" (15.88mm)x 43" (1092.2mm)
<b>ORDER #:</b> 12249	Deck Drive Belt. Fits Turf Tiger. Raw edge, cogged, aramid cord construction.	<b>SUGG LIST:</b> <b>\$32.13</b> 5/8" (15.88mm)x 43-3/4" (1111.25mm)
<b>ORDER #:</b> 12069	Deck Drive Belt. Fits SMTC 48V. Raw edge, cogged, aramid cord construction.	<b>SUGG LIST:</b> <b>\$33.87</b> 43/64" (17.07mm)x 50" (1270mm)
<b>ORDER #:</b> 10047	Deck Drive Belt. Deck drive belt for 48" RH cutter deck Turf Tiger units. *Aramid fiber.	<b>SUGG LIST:</b> <b>\$35.46</b> 21/32" (16.67mm)x 50" (1270mm)
<b>ORDER #:</b> 12049	Pump Drive Belt. Fits SWZ. Raw edge, laminated, aramid cord construction.	<b>SUGG LIST:</b> <b>\$37.52</b> 1/2" (12.70mm)x 50-1/2" (1282.70mm)
<b>ORDER #:</b> 10045	Transmission Drive Belt. Transmission drive belt fits 40", 48" & 52" Turf Tiger units. *Aramid fiber.	<b>SUGG LIST:</b> <b>\$20.81</b> 1/2" (12.70mm)x 52" (1320.8mm)
<b>ORDER #:</b> 5235	Wheel Drive Belt. Double "A" Section, Banded Belt, Fits Belt Drive Walk Behind. Raw Edge.	<b>SUGG LIST:</b> <b>\$75.68</b> 1-1/8" (28.58mm)x 52-3/8" (1330.33mm)
<b>ORDER #:</b> 7789	Blade Belt. Used on Scag 48" cut mid size mowers. Covered. *Aramid fiber.	<b>SUGG LIST:</b> <b>\$32.31</b> 5/8" (15.88mm)x 52-29/32" (1343.82mm)
<b>ORDER #:</b> 12070	Deck Drive Belt. Fits SMWC 52V. Raw edge, cogged, aramid cord construction.	<b>SUGG LIST:</b> <b>\$36.78</b> 43/64" (17.07mm)x 54-1/2" (1384.30mm)
<b>ORDER #:</b> 10049	Deck Drive Belt. Deck drive belt for 52" RH cutter deck Turf Tiger units. *Aramid fiber.	<b>SUGG LIST:</b> <b>\$37.99</b> 21/32" (16.67mm)x 55" (1397mm)

<b>ORDER #:</b> 10402	Pump Drive Belt. Fits models SWZ-52 & 61 *Aramid cord construction, raw edge belt.	<b>SUGG LIST:</b> <b>\$41.99</b> 17/32" (13.49mm)x 57" (1447.8mm)
<b>ORDER #:</b> 10914	Pump Drive Belt. Fits Turf Tiger models. Raw edge, laminated, aramid cord construction. edge, *Aramid cord construction.	<b>SUGG LIST:</b> <b>\$26.59</b> 1/2" (12.70mm)x 59" (1498.6mm)
<b>ORDER #:</b> 10050	Pump Drive Belt. Fits Scag 52" & 61" cut Turf Tiger.	<b>SUGG LIST:</b> <b>\$29.08</b> 1/2" (12.70mm)x 60" (1524mm)
<b>ORDER #:</b> 10043	Pump Drive Belt. Deck belt fits 52" & 61" Turf Tiger units. *Aramid fiber.	<b>SUGG LIST:</b> <b>\$24.21</b> 1/2" (12.70mm)x 60-55/64" (1545.83mm)
<b>ORDER #:</b> 10319	Pump Drive Belt. Fits Tiger Cub. *Aramid Cord, laminated, raw edge belt.	<b>SUGG LIST:</b> <b>\$19.87</b> 1/2" (12.70mm)x 61-5/8" (1565.28mm)
<b>ORDER #:</b> 12067	Pump Drive Belt. Fits STC. Raw edge, cogged, aramid cord construction.	<b>SUGG LIST:</b> <b>\$55.16</b> 43/64" (17.07mm)x 65" (1651mm)
<b>ORDER #:</b> 12068	Pump Drive Belt. Fits STC. Raw edge, cogged, aramid cord construction.	<b>SUGG LIST:</b> <b>\$51.22</b> 43/64" (17.07mm)x 65-5/8" (1666.88mm)
<b>ORDER #:</b> 12248	Pump Drive Belt. Fits 52" Turf Tiger. Raw edge, laminated, aramid cord construction.	<b>SUGG LIST:</b> <b>\$36.99</b> 1/2" (12.70mm)x 79-1/2" (2019.3mm)
<b>ORDER #:</b> 10318	Pump Drive Belt. Fits Turf Tiger. *Aramid Cord, laminated, raw edge belt.	<b>SUGG LIST:</b> <b>\$37.81</b> 1/2" (12.70mm)x 79-13/16" (2027.24mm)
<b>ORDER #:</b> 12085	Pump Drive Belt. Fits Turf Tiger. Raw edge, cogged, aramid cord construction.	<b>SUGG LIST:</b> <b>\$65.07</b> 5/8" (15.88mm)x 80" (2032mm)
<b>ORDER #:</b> 13257	Pump Drive Belt. Laminated, Aramid cord construction.	<b>SUGG LIST:</b> <b>\$34.48</b> 1/2" (12.70mm)x 80-49/64" (2051.45mm)
<b>ORDER #:</b> 5236	Cutter Deck Belt. Fits Belt Drive Walk Behind 36" cut. Covered.	<b>SUGG LIST:</b> <b>\$30.25</b> 5/8" (15.88mm)x 82" (2082.8mm)

<b>ORDER #:</b> 7631	Blade Drive Belt. For 48" and 60" decks. Covered.	<b>SUGG LIST:</b> <b>\$35.92</b> 5/8" (15.88mm)x 86" (2184.4mm)
<b>ORDER #:</b> 7790	Engine to Blade. Used on Scag 48" cut mid size mowers. Covered. *Aramid fiber.	<b>SUGG LIST:</b> <b>\$45.36</b> 5/8" (15.88mm)x 89-39/64" (2276.08mm)
<b>ORDER #:</b> 10403	Blade Drive Belt. Fits models SWZ-48. *Aramid cord construction, raw edge belt.	<b>SUGG LIST:</b> <b>\$64.24</b> 11/16" (17.46mm)x 115" (2921mm)
<b>ORDER #:</b> 10046	Deck Drive Belt. Deck drive belt for 48" Turf Tiger units. *Aramid fiber.	<b>SUGG LIST:</b> <b>\$65.04</b> 21/32" (16.67mm)x 116-3/4" (2965.45mm)
<b>ORDER #:</b> 12071	Deck Drive Belt. Fits STC 48V. Wrapped, aramid cord construction.	<b>SUGG LIST:</b> <b>\$48.71</b> 5/8" (15.88mm)x 117-1/2" (2984.50mm)
<b>ORDER #:</b> 8714	Drive Belt. Fits models STHM with CV20 & CV22 hp. For 1994 & newer 61" cut models. Covered.	<b>SUGG LIST:</b> <b>\$59.40</b> 5/8" (15.88mm)x 117-1/2" (2984.50mm)
<b>ORDER #:</b> 10048	Deck Drive Belt. Deck drive belt for 52" Turf Tiger units. *Aramid fiber.	<b>SUGG LIST:</b> <b>\$87.99</b> 21/32" (16.67mm)x 120" (3048mm)
<b>ORDER #:</b> 10404	Blade Drive Belt. Replaces Scag 48752.	<b>SUGG LIST:</b> <b>\$76.70</b> 21/32" (16.67mm)x 120-3/8" (3057.53mm)
<b>ORDER #:</b> 10411	Blade Drive Belt. Fits model STT-52. Raw edge, *Aramid cord construction.	<b>SUGG LIST:</b> <b>\$65.72</b> 21/32" (16.67mm)x 123-15/16" (3148.01mm)
<b>ORDER #:</b> 12072	Deck Drive Belt. Fits STC & STWC 52V. Wrapped, aramid cord construction.	<b>SUGG LIST:</b> <b>\$59.70</b> 5/8" (15.88mm)x 125-1/2" (3187.70mm)
<b>ORDER #:</b> 10407	Blade Drive Belt. Fits model SMZ-52. Wrapped, *Aramid cord construction.	<b>SUGG LIST:</b> <b>\$64.27</b> 21/32" (16.67mm)x 128-13/32" (3261.52mm)
<b>ORDER #:</b> 12073	Deck Drive Belt. Fits STWC 61V. Wrapped, aramid cord construction.	<b>SUGG LIST:</b> <b>\$59.70</b> 5/8" (15.88mm)x 135-1/2" (3441.70mm)

<b>ORDER #:</b> 10405	Blade Drive Belt. Fits model SMZ-61. Wrapped, *Aramid cord construction.	<b>SUGG LIST:</b> <b>\$90.64</b> 21/32" (16.67mm)x 135-1/2" (3441.70mm)
<b>ORDER #:</b> 14593	Deck Belt. Fits models SCZ61V, SCZ72V Cheetah, SMT-72V, STT-28CAT-SS, STT61V Turf Tiger. Wrapped molded, Aramid cord construction, double cover, clutching, (brown).	<b>SUGG LIST:</b> <b>\$77.64</b> 5/8" (15.88mm)x 137" (3479.8mm)
<b>ORDER #:</b> 10044	Deck Drive Belt. Deck drive belt fits 61" Turf Tiger units. *Aramid fiber.	<b>SUGG LIST:</b> <b>\$71.78</b> 5/8" (15.88mm)x 139-61/64" (3554.81mm)
<b>ORDER #:</b> 12718	Deck Belt. Fits model Freedom Z 48" deck. Wrapped -molded, neoprene, aramid cord construction, double cover, wrapped, clutching, (white).	<b>SUGG LIST:</b> <b>\$63.23</b> 5/8" (15.88mm)x 140-3/4" (3575.05mm)
<b>ORDER #:</b> 10365	Cutter Deck Belt. Fits 48" Tiger Cub. *Aramid Cord, wrapped clutching cover.	<b>SUGG LIST:</b> <b>\$74.46</b> 21/32" (16.67mm)x 148" (3759.2mm)
<b>ORDER #:</b> 12719	Deck Belt. Fits model Freedom Z 52" deck. Wrapped -molded, neoprene, aramid cord construction, double cover, wrapped, clutching, (white).	<b>SUGG LIST:</b> <b>\$63.23</b> 5/8" (15.88mm)x 148-1/4" (3765.55mm)
<b>ORDER #:</b> 12371	Deck Belt. Fits 52" up to 2005. Fits models SMTC- 52' cut Tiger Cub. Raw edge, laminated, aramid cord construction.	<b>SUGG LIST:</b> <b>\$71.66</b> 5/8" (15.88mm)x 154-7/8" (3933.83mm)
<b>ORDER #:</b> 12233	Deck Drive Belt. Fits 72" Turf Tiger. Wrapped molded, aramid cord construction.	<b>SUGG LIST:</b> <b>\$79.89</b> 5/8" (15.88mm)x 162-1/2" (4127.50mm)
<b>ORDER #:</b> 12824	Deck Belt. Fits Scag Tiger Cub SMTC-61, Wildcat 61" deck. Also fits Ferris ISZ Zero turn 61" deck. Wrapped-molded, aramid cord construction, double cover, clutching, (salt/pepper color).	<b>SUGG LIST:</b> <b>\$80.94</b> 5/8" (15.88mm)x 175-29/32" (4468.02mm)

## SIMPLICITY

<b>ORDER #:</b> 14801	V Belt. Fits Snapper 42" cut tractor. Wrapped molded, aramid cord construction, double cover, clutching, (brown).	<b>SUGG LIST:</b> <b>\$42.80</b> 1/2" (12.70mm)x 94-9/20" (2399.03mm)
<b>ORDER #:</b> 6874	Drive Belt. 1665638. Covered.	<b>SUGG LIST:</b> <b>\$41.95</b> 1/2" (12.70mm)x 126-3/16" (3205.16mm)

# SNAPPER

<b>ORDER #:</b> 669	Belt. Used on V-21's. For 3-1/2 - 4 hp mowers. Raw Edge.	<b>SUGG LIST:</b> <b>\$6.25</b> 3/8" (9.53mm)x 24-1/2" (622.30mm)
<b>ORDER #:</b> 11677	Drive Belt. Hex. General Purpose, Aramid cord construction, double cover, clutching.	<b>SUGG LIST:</b> <b>\$13.95</b> 3/8" (9.53mm)x 24-1/2" (622.30mm)
<b>ORDER #:</b> 670	Belt. Fits 5 hp commercial. Cogged.	<b>SUGG LIST:</b> <b>\$6.50</b> 3/8" (9.53mm)x 25" (635mm)
<b>ORDER #:</b> 5233	Wheel Drive Belt. cogged.	<b>SUGG LIST:</b> <b>\$25.55</b> 5/8" (15.88mm)x 44" (1117.6mm)
<b>ORDER #:</b> 673	Belt. For 25", 26", 28" and 30" cut mowers 1991 & older. 6 sided. Oil and heat resistant. Double V.	<b>SUGG LIST:</b> <b>\$13.95</b> AAx 68" (1727.20mm)
<b>ORDER #:</b> 7838	Engine to Blade Belt. Fits 26" thru 33" cut models 7-9 series, Snapper rear engine riders. *Aramid fiber. Double V.	<b>SUGG LIST:</b> <b>\$16.95</b> AAx 73" (1854.2mm)
<b>ORDER #:</b> 9483	Blade Drive Belt. Fits 28", 30" & 33" cut rear engine riders, series 16. General purpose, *Aramid fiber. Clutching cover. Double V.	<b>SUGG LIST:</b> <b>\$27.95</b> AAx 73-3/4" (1873.25mm)
<b>ORDER #:</b> 8767	Spindle Belt. Fits 28", 30" & 33" rear engine riders. V-belt. *Aramid fiber. Covered.	<b>SUGG LIST:</b> <b>\$39.95</b> 5/8" (15.88mm)x 75-1/8" (1908.18mm)
<b>ORDER #:</b> 7129	Blade Belt. Fits series 1 & 2, models LT11, LT16, YT12D, YT18H, GT180H. Covered.	<b>SUGG LIST:</b> <b>\$32.95</b> 1/2" (12.70mm)x 103-3/32" (2618.58mm)
<b>ORDER #:</b> 8768	Blade Belt. Fits 42" rear engine riders. V-belt. *Aramid fiber. Covered.	<b>SUGG LIST:</b> <b>\$42.50</b> 5/8" (15.88mm)x 110-1/4" (2800.35mm)
<b>ORDER #:</b> 14140	V Belt. Aramid cord construction, double cover, clutching, (brown).	<b>SUGG LIST:</b> <b>\$68.75</b> 1/2" (12.70mm)x 119-1/4" (3028.95mm)

- ORDER #:** 8075 Deck Belt. Fits series 1 & 2, models LT, YT, YT12D, YT16D, YT18H, GT180H. Covered. **SUGG LIST:** **\$34.95**  
1/2" (12.70mm)x  
139" (3530.6mm)
- ORDER #:** 14068 Deck Belt. Fits ZRT Twin Stick 48" Zero turn rider. **SUGG LIST:** **\$110.30**  
5/8" (15.88mm)x  
150" (3810mm)
- ORDER #:** 14166 Deck Belt. Fits Snapper model RZT 52". Wrapped-molded, aramid cord construction, double cover, clutching, (brown color). **SUGG LIST:** **\$79.95**  
1/2" (12.70mm)x  
158" (4013.2mm)

## STIHL

- ORDER #:** 13117 Drive Belt. Fits Stihl model TS420 Cutquik cut off saws. 5 ribs, polyester cord construction. **SUGG LIST:** **\$46.83**  
7/16" (11.11mm)x  
31-1/2" (800.10mm)

## TORO

- ORDER #:** 8887 Blade Brake Belt. Fits Toro Homeowner models 20624, 20684, 20695. Raw edge, cogged. \*Aramid fiber. Cogged. **SUGG LIST:** **\$10.99**  
1/2" (12.70mm)x  
23-59/64" (607.62mm)
- ORDER #:** 12687 Snowthrower Auger Belt. Fits Power Life Snowthrowers 1997-2010. Raw edge, laminated, aramid cord construction. **SUGG LIST:** **\$12.75**  
3/8" (9.53mm)x  
29-7/32" (742.16mm)
- ORDER #:** 10210 Drive Belt. Fits most 2 stage snowthrowers. Raw edge, polyester cord construction. **SUGG LIST:** **\$12.69**  
1/2" (12.70mm)x  
30" (762mm)
- ORDER #:** 13247 V Belt. Fits 21" Recycler. Fiberglass cord construction, single cover, clutching, (white). **SUGG LIST:** **\$8.29**  
3/8" (9.53mm)x  
31-15/16" (811.21mm)
- ORDER #:** 7952 Replaces Toro. Fits snowmaster S200 & S620. **SUGG LIST:** **\$18.56**  
3/32" (2.38mm)x  
33" (838.2mm)

<b>ORDER #:</b> 14718	Snowthrower Drive Belt. Fits Snowthrower models CCR2400, CCR2450, CCR2500, CCR3000, CCR3600 & CCR3650.	<b>SUGG LIST:</b> <b>\$17.30</b> 5 Ribx 33-7/8" (860.43mm)
<b>ORDER #:</b> 9861	Snowthrower Belt. Fits model CCR2000. Poly ribbed belt.	<b>SUGG LIST:</b> <b>\$16.01</b> 9/16" (14.29mm)x 34" (863.6mm)
<b>ORDER #:</b> 10090	Snowthrower Belt. Fits model CCR1000. Raw edge. *Aramid fiber.	<b>SUGG LIST:</b> <b>\$28.05</b> 3/8" (9.53mm)x 34-1/2" (876.30mm)
<b>ORDER #:</b> 14042	Drive Belt. Fits Recycler and Super Recycler self-propelled belt for walk-behind mowers. Covered belt.	<b>SUGG LIST:</b> <b>\$19.39</b> 3/8" (9.53mm)x 35" (889mm)
<b>ORDER #:</b> 10746	V Belt. Raw edge, laminated, aramid cord construction.	<b>SUGG LIST:</b> <b>\$24.97</b> 1-1/4" (31.75mm)x 39-5/16" (998.54mm)
<b>ORDER #:</b> 13573	Pump Drive Belt. Fits 30000 series commercial walk behind. Wrap molded, Aramid cord construction, double cover, friction.	<b>SUGG LIST:</b> <b>\$29.47</b> ) 1/2" (12.70mm)x 46-15/16" (1192.21mm)
<b>ORDER #:</b> 5820	Transmission Belt. For 32" rear engine rider. Covered.	<b>SUGG LIST:</b> <b>\$20.43</b> 1/2" (12.70mm)x 47-1/2" (1206.50mm)
<b>ORDER #:</b> 5231	Wheel Drive Belt. Double "A". For 32", 36", 44" & 52". Raw Edge.	<b>SUGG LIST:</b> <b>\$59.98</b> 1/2" (12.70mm)x 50-3/8" (1279.53mm)
<b>ORDER #:</b> 13408	Pump Belt. Fits models 74170, Z147 Z Master. Raw edge, Aramid cord construction	<b>SUGG LIST:</b> <b>\$36.45</b> 1/2" (12.70mm)x 52-1/4" (1327.15mm)
<b>ORDER #:</b> 12916	Pump Belt. Accessory drive, pump belt, used on Z-Master. 5 rib belt.	<b>SUGG LIST:</b> <b>\$27.80</b> 11/16" (17.46mm)x 57-3/16" (1452.56mm)
<b>ORDER #:</b> 14129	Drive Belt. Hydro pump drive belt. Fits Time Cutter Z4200, Z4220, Z4235, Z5000, Z5020, Z5030, Z5035, Z5040, Z5060. Cogged belt.	<b>SUGG LIST:</b> <b>\$22.19</b> 1/2" (12.70mm)x 62-1/2" (1587.50mm)
<b>ORDER #:</b> 14537	Drive Belt. Fits TimeCutter & Exmark Quests. Cogged, polyester cord construction.	<b>SUGG LIST:</b> <b>\$20.56</b> 1/2" (12.70mm)x 64" (1625.6mm)

<b>ORDER #:</b> 5821	Deck Belt. "A" section belt, For 32" rear engine rider. Covered. Construction, double cover, clutching, (brown).	<b>SUGG LIST:</b> <b>\$22.42</b> 1/2" (12.70mm)x 65-1/2" (1663.70mm)
<b>ORDER #:</b> 6972	Engine to Blade Belt. Fits 52" midsize decks. Covered	<b>SUGG LIST:</b> <b>\$41.54</b> 5/8" (15.88mm)x 71" (1803.4mm)
<b>ORDER #:</b> 14319	Pump Belt. Fits models Titan & Exmark Quest (42", 48" & 52") Raw edge cogged belt.	<b>SUGG LIST:</b> <b>\$31.16</b> 1/2" (12.70mm)x 75-3/8" (1914.53mm)
<b>ORDER #:</b> 14365	Drive Belt. Fits models 71193, 14-38HXL lawn tractor. Also replaces John Deere GX21986, M40223, M86996. Traction drive belt for 100 series with 54" deck. Wrapped molded, Aramid cord construction, double friction cover.	<b>SUGG LIST:</b> <b>\$27.57</b> 1/2" (12.70mm)x 87-1/2" (2222.50mm)
<b>ORDER #:</b> 7171	Engine to Deck Belt. Polyester cord construction. Fits 42" and 48" cut side discharge. Rear engine riders. (older Wheel Horse models.) Covered.	<b>SUGG LIST:</b> <b>\$32.45</b> 1/2" (12.70mm)x 103" (2616.2mm)
<b>ORDER #:</b> 6837	Blade to Blade Belt. Fits 44" & 52" midsize decks. Double V.	<b>SUGG LIST:</b> <b>\$49.57</b> AAx 103-1/2" (2628.90mm)
<b>ORDER #:</b> 13572	Spindle Drive Belt. Fits 30000 series commercial walk behind with 48" deck. Wrap molded, Aramid cord construction, double cover, friction.	<b>SUGG LIST:</b> <b>\$47.96</b> 1/2" (12.70mm)x 105-19/64" (2674.54mm)
<b>ORDER #:</b> 11845	Deck Drive Belt. Wrapped molded general purpose, aramid cord, double clutching cover.	<b>SUGG LIST:</b> <b>\$39.08</b> 1/2" (12.70mm)x 109-7/64" (2771.38mm)
<b>ORDER #:</b> 13570	Spindle Drive Belt. Fits 30000 series commercial walk behind with 52" deck. Wrap molded, Aramid cord construction, double cover, semi-dry black.	<b>SUGG LIST:</b> <b>\$59.00</b> 1/2" (12.70mm)x 111" (2819.4mm)
<b>ORDER #:</b> 14130	Deck Belt. Fits Z4200 42" TimeCutter Z. Wrapped belt.	<b>SUGG LIST:</b> <b>\$54.18</b> 1/2" (12.70mm)x 112-1/8" (2847.98mm)
<b>ORDER #:</b> 14811	Deck Belt. Fits 42" deck models SS4200, SS4235, SS4260. Aramid cord	<b>SUGG LIST:</b> <b>\$31.70</b> 1/2" (12.70mm)x 113-1/10" (2872.74mm)
<b>ORDER #:</b> 12928	Drive Belt. Fits Z4200, Z42, Z38, Z380, Z530. Wrapped-molded, aramid cord construction, double cover.	<b>SUGG LIST:</b> <b>\$51.20</b> 1/2" (12.70mm)x 117" (2971.8mm)

<b>ORDER #:</b> 10387	Deck Belt. Fits Toro Groundmaster 62" ("AA") belt. Wrapped polyester cord construction.	<b>SUGG LIST:</b> <b>\$38.22</b> 1/2" (12.70mm)x 122-1/8" (3101.98")
<b>ORDER #:</b> 12672	V Belt. Fits Timecutter Z5000-Z5040. Wrapped molded Aramid cord construction double cover, clutching, (white).	<b>SUGG LIST:</b> <b>\$82.89</b> 1/2" (12.70mm)x 140-1/10" (3558.54mm)
<b>ORDER #:</b> 14733	Deck Belt. Fits 50" TimeCutter SS5000, SS5060 & Quest models.	<b>SUGG LIST:</b> <b>\$37.73</b> 1/2" (12.70mm)x 141-1/2" (3594.10mm)
<b>ORDER #:</b> 10051	Engine to Deck Belt. Fits 62" Z-Master. *Aramid fiber.	<b>SUGG LIST:</b> <b>\$72.04</b> 21/32" (16.67mm)x 142-1/10" (3609.34mM)
<b>ORDER #:</b> 14318	Deck Belt. Fits 54" ZX5400 Titan deck belt. Wrapped belt.	<b>SUGG LIST:</b> <b>\$118.49</b> 5/8" (15.88mm)x 175-7/8" (4467.225mm)
<b>ORDER #:</b> 12867	V Belt. Fits Z-Master Z400 series. Aramid double clutching cover, (white).	<b>SUGG LIST:</b> <b>\$80.94</b> 5/8" (15.88mm)x 176" (4470.4mm)
<b>ORDER #:</b> 14756	Drive Belt. Fits 60" Titan deck model. Aramid cord construction, double friction cover.	<b>SUGG LIST:</b> <b>\$124.76</b> 1/2" (12.70mm)x 184-9/10" (4696.46mm)
<b>ORDER #:</b> 12805	Drive Belt. Fits model Z587, 60" deck. Wrapped-molded, aramid cord construction, double cover, wrapped.	<b>SUGG LIST:</b> <b>\$114.00</b> 5/8" (15.88mm)x 226" (5740.4mm)
<b>ORDER #:</b> 12729	Engine PTO to Deck Belt. Fits model Z500 Z-Master 60" deck. Wrapped-molded, aramid cord construction, double over, wrapped.	<b>SUGG LIST:</b> <b>\$106.96</b> 5/8" (15.88mm)x 242" (6146.8mm)
<b>ORDER #:</b> 12730	Engine PTO to Deck Belt. Fits model Z500 Z-Master 72" deck. Wrapped-molded, aramid cord construction, double over, wrapped.	<b>SUGG LIST:</b> <b>\$120.25</b> 5/8" (15.88mm)x 264" (6705.6mm)

## **TROY BILT**

<b>ORDER #:</b> 10821	Tiller Belt. Fits Horse tiller models. Raw edge, laminated, fiberglass cord construction.	<b>SUGG LIST:</b> <b>\$13.74</b> 1/2" (12.70mm)x 21-3/4" (552.45mm)
-----------------------	---	---

<b>ORDER #:</b> 869	Belt. Transmission Belt. Poly grooved belt. Multi Ribbed.	<b>SUGG LIST:</b> <b>\$6.50</b> 3/8" (9.53mm)x 22" (558.8mm)
<b>ORDER #:</b> 10822	Drive Belt. 4 speed Horse models. Type 2. Raw edge, laminated, aramid cord construction.	<b>SUGG LIST:</b> <b>\$12.82</b> 1/2" (12.70mm)x 22-1/4" (565.15mm)

# WALKER

<b>ORDER #:</b> 8819	Blower Belt. Fits model T blower. Cogged belt, Polyester cord construction.	<b>SUGG LIST:</b> <b>\$9.49</b> 3/8" (9.53mm)x 28" (711.2mm)
<b>ORDER #:</b> 10321	Blower Belt. Fits new style blowers. 4 Rib poly, *Aramid Cord.	<b>SUGG LIST:</b> <b>\$31.35</b> 9/16" (14.29mm)x 28-17/32" (724.69mm)
<b>ORDER #:</b> 8820	PTO Belt. Fits model T. Cogged belt, Polyester cord construction.	<b>SUGG LIST:</b> <b>\$17.37</b> 3/8" (9.53mm)x 35-1/2" (901.70mm)
<b>ORDER #:</b> 12246	PTO Drive Belt. Raw edge cog, polyester cord construction.	<b>SUGG LIST:</b> <b>\$17.97</b> 3/8" (9.53mm)x 37-1/2" (952.50mm)
<b>ORDER #:</b> 10320	PTO Triple Belt. Fits Diesel units. *Aramid Cord, wrapped clutching cover.	<b>SUGG LIST:</b> <b>\$45.45</b> 1-1/4" (31.75mm)x 38" (965.2mm)
<b>ORDER #:</b> 10323	PTO Drive Belt. Triple belt fits T models. Laminated Aramid cord construction.	<b>SUGG LIST:</b> <b>\$48.20</b> 1-1/4" (31.75mm)x 40-7/16" (1027.11mm)
<b>ORDER #:</b> 10322	Ground Drive Belt. Fits hydros after 1996. 4 Rib poly-belt, polyester cord.	<b>SUGG LIST:</b> <b>\$35.20</b> 9/16" (14.29mm)x 47" (1193.8mm)
<b>ORDER #:</b> 8798	Gound Drive Belt. Fits Hydro Pro model T. V-belt, double cogged, Dacron cord construction.	<b>SUGG LIST:</b> <b>\$16.19</b> 1/2" (12.70mm)x 47-1/16" (1195.39mm)

# WRIGHT STANDER

<b>ORDER #:</b> 14564	Pump Drive Belt. Fits Stander 48", 52" and 61" decks.	<b>SUGG LIST:</b> <b>\$30.10</b> 1/2" (12.70mm)x 53" (1346.2mm)
<b>ORDER #:</b> 14562	Deck Belt. Fits 48" deck model BX50.	<b>SUGG LIST:</b> <b>\$37.49</b> 5/8" (15.88mm)x 53-1/4" (1352.55mm)
<b>ORDER #:</b> 14566	Blade Drive Belt. Fits 52" deck models Stander ZK, RH (Rapid-Hite), Sentar Sport, Sport X (SN55864 and up), Stander X (SN53014 and up).	<b>SUGG LIST:</b> <b>\$39.40</b> 5/8" (15.88mm)x 57-3/8" (1457.325mm)
<b>ORDER #:</b> 14565	Pump Drive Belt. Fits Stander X (SN53014 and up), Sentar (SN26980 and up).	<b>SUGG LIST:</b> <b>\$42.40</b> 5/8" (15.88mm)x 64-5/16" (1633.54mm)
<b>ORDER #:</b> 14567	Engine to Blade Belt. Fits 61" deck models Stander X (SN55853 and up). 52" deck models (SN28215 and up).	<b>SUGG LIST:</b> <b>\$53.00</b> 5/8" (15.88mm)x 84-5/16" (2141.54mm)
<b>ORDER #:</b> 14563	Engine to Deck Belt. Fits 48" & 61" decks and Rapid-Hite/Sentar Sport 42" decks.	<b>SUGG LIST:</b> <b>\$51.77</b> 5/8" (15.88mm)x 88" (2235.2mm)

# YAZOO/KEES

<b>ORDER #:</b> 7894	Engine to Blade Belt. Fits 30" Red Rider rear engine rider. *Aramid fiber. Double V.	<b>SUGG LIST:</b> <b>\$42.25</b> 1/2" (12.70mm)x 80-1/8" (2035.18mm)
<b>ORDER #:</b> 10823	Deck Belt. Fits 52" Max 2 series "ZERO TURN" also replaces Husqvarna 539-104335 XP large frame mowers. Raw edge, laminated, aramid cord construction.	<b>SUGG LIST:</b> <b>\$76.17</b> 5/8" (15.88mm)x 163-1/2" (4152.90mm)
<b>ORDER #:</b> 10824	Deck Belt. Fits 61" Max 2 series "ZERO TURN" & Husqvarna 539-104336 XP large frame mowers. Raw edge, laminated, aramid cord construction.	<b>SUGG LIST:</b> <b>\$78.19</b> 5/8" (15.88mm)x 183-3/8" (4657.73mm)
<b>ORDER #:</b> 10825	Deck Belt. Fits 72" Max 2 series "ZERO TURN" & Husqvarna 539-105477 large frame mowers. Raw edge, laminated, aramid cord construction.	<b>SUGG LIST:</b> <b>\$90.12</b> 5/8" (15.88mm)x 198-1/2" (5041.90mm)

# Pulleys



## **PULLEYS**..... 175

- » *Offset V Belt Idlers*.....176
- » *Offset Flat Idlers* .....176
- » *Offset Flat Idlers without Flanges* .....178
- » *Flush Flat Idlers*.....178
- » *Flush V Belt Idlers* .....179
- » *Steel V Belt Pulleys* .....180
- » *Heavy Duty Cast Iron V Belt Pulleys*.....180
- » *OEM Direct Replacement Pulleys by Size* .....181

### OFFSET V BELT IDLERS

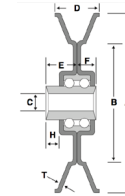

Order No			A	B	C	D	E	F	H	T	Sugg. List
729	S	IV-40	2-5/8"	1-3/4"	3/8"	19/32"	1/2"	11/32"	3/16"	.050"	\$17.77
7127	P*		3"	1-31/32"	1/2"	11/16"	1/4"	1/4"	N/A	.086"	\$12.50
730	S	IV-42	3-1/16"	2"	3/8"	3/4"	1/2"	11/32"	3/32"	.060"	\$9.63
728	S	IV-39A	3-1/16"	2"	3/8"	11/16"	1/2"	11/32"	1/8"	.060"	\$11.73
731	S	IV-48A	3-1/16"	2"	3/8"	5/8"	1/2"	11/32"	5/32"	.060"	\$9.25
732	S	IV-48	3-1/8"	2-1/8"	3/8"	3/8"	1/2"	11/32"	3/16"	.060"	\$9.63
2182	S		3-1/2"	2-1/16"	3/8"	3/4"	1/2"	11/32"	1/8"	.060"	\$12.75
733	S	IV-64A	4"	3"	3/8"	21/32"	1/2"	11/32"	3/16"	.060"	\$12.45
734	S*	IV-64B	4"	2-3/4"	3/8"	13/16"	1/2"	11/32"	3/32"	.060"	\$12.77
5869	S*		4"	2-5/8"	3/8"	1"			3/16"	.074"	\$22.95
2183	S		4-1/2"	3"	3/8"	3/4"	7/32"		7/32"	.075"	\$24.80
5870	S*		4-1/2"	3-7/32"	3/8"	3/4"	17/32"			.074"	\$18.50
7918	S		4-15/16"	N/A	3/8"	15/16"	21/32"	1/4"	11/32"	.075"	\$33.42
10158	P*	VIP500	5"	4.79"	17mm	0.87"		11/16"			\$14.54
10159	P*	VIP600	6"	5"	17mm	1.15"		11/16"			\$16.45

(\*) Denotes Heavy Duty Bearing

S=Steel

P=Plastic

### OFFSET FLAT IDLERS

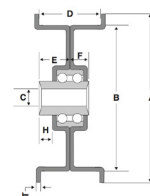

Order No			A	B	C	D	E	F	H	T	Sugg. List
718	S	IF-3011	2"	1-7/8"	3/8"	3/4"	1/2"	11/32"	1/16"	.050"	\$11.89
715	S	IF-3008	2-1/8"	1-7/8"	3/8"	1/2"	1/2"	11/32"	1/16"	.050"	\$9.50
8478	S		2-1/4"	1-7/8"	1/4"	1/2"	1/2"	11/32"	1/2"	.050"	\$7.85
719	S	IF-3612	2-15/32"	2-1/4"	3/8"	3/4"	1/2"	11/32"	1/16"	.050"	\$10.14
720	P	IF-3616	2-15/32"	2-1/4"	3/8"	1"	5/8"	11/32"	1/16"	.050"	\$9.66
2181	S*		2-1/2"	2"	5/16"	13/16"	3/4"		3/32"	.040"	\$23.05
2175	S*		2-1/2"	2"	3/8"	13/16"	3/4"	11/32"	3/16"	.050"	\$9.10
738	S*		2-1/2"	2"	5/8"	5/8"	7/32"	7/32"	N/A	.040"	\$13.48

**OFFSET FLAT IDLERS (CONTINUED)**

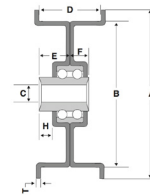

Order No.		A	B	C	D	E	F	H	T	Sugg. List
2188	S*	3-1/32"	2-3/4"	3/8"	7/8"	11/16"	9/32"	1/8"	.047"	\$13.93
2176	S IF-4412	3-1/8"	2-3/4"	3/8"	3/4"	1/2"	11/32"	1/16"	.050"	\$10.14
722	S IF-4812	3-7/32"	3"	3/8"	3/4"	1/2"	11/32"	1/16"	.050"	\$13.18
714	S IF-4424	3-1/4"	2-3/4"	3/8"	1-1/4"	7/8"	11/32"	3/32"	.050"	\$11.85
721	S IF-4414	3-1/4"	2-3/4"	3/8"	7/8"	5/8"	11/32"	1/8"	.050"	\$13.18
7978	N	3-23/64"	2-3/4"	1/2"	7/8"	1/4"	1/4"	N/A	.090"	\$11.50
7983	N	3-7/16"	3"	3/8"	3/4"	11/16"	15/64"	7/16"	.090"	\$25.19
8005	S	3-1/2"	2-3/4"	3/8"	1-1/4"	7/8"	3/8"	9/16"	.074"	\$18.56
724	S IF-5216	3-9/16"	3-1/4"	3/8"	1"	5/8"	11/32"	1/16"	.060"	\$14.99
725	S IF-5220	3-5/8"	3-1/4"	3/8"	1-1/4"	3/4"	11/32"	1/16"	.060"	\$12.50
723	S IF-5212	3-3/4"	3-1/4"	3/8"	3/4"	1/2"	11/32"	1/16"	.060"	\$10.14
8588	S	4"	3-1/8"	3/8"	3/4"	3/4"	11/32"	31/64"	.060"	\$20.41
8373	S	4-1/8"	3-15/32"	3/4"	25/32"				.075"	\$27.00
8602	N	4-1/8"	3-1/2"	3/8"	7/8"	5/8"	1/4"	17/64"	.125"	\$16.73
8245	S	4-1/8"	3-1/4"	3/8"	1-1/4"	1-3/8"	1/4"	1-5/64"	.060"	\$19.50
7157	S*	4-1/4"	3-3/4"	3/8"	1"	3/4"		3/32"	.060"	\$28.51
726	S IF-6412	4-1/2"	4"	3/8"	3/4"	1/2"	11/32"	1/16"	.040"	\$13.75
727	S IF-6416	4-1/2"	4"	3/8"	1"	5/8"	11/32"	1/16"	.040"	\$14.88
2189	S*	4-1/2"	4"	3/8"	2"	1-1/4"	5/16"	1/8"	.059"	\$33.55
7937	N	4-19/32"	4"	1/2"	23/32"	1/4"	1/4"		.090"	\$10.00
7861	N	4-19/32"	4"	3/8"	23/32"	21/32"	1/4"	9/16"	.090"	\$15.32
5714	S*	4-5/8"	4"	3/8"	11/16"	11/16"	5/16"	1/8"	.074"	\$26.31
7182	N*	4-3/4"	4"	3/8"	7/8"	3/4"	5/16"	1/16"	.090"	\$9.63
7126	N	4-3/4"	4"	1/2"	1-3/8"	1/4"	1/4"		.125"	\$10.95
777	S	4-7/8"	4-1/16"	3/8"	3/4"	5/8"	.236"	1/16"	.075"	\$19.50
5712	S*	5-3/16"	5"	3/8"	1-3/16"	1"	5/16"	3/16"	.074"	\$31.60
6572	S*	5-15/16"	5"	3/8"	1-1/4"	3/4"	9/32"	1/16"	.074"	\$21.11
7176	S	6-3/4"	6"	1/2"	3/4"	7/16"	7/16"		.074"	\$53.60

(\*) Denotes Heavy Duty Bearing

S=Steel

P=Plastic

### OFFSET FLAT IDLERS WITHOUT FLANGES

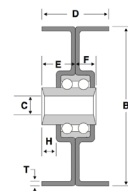

Part No.			B	C	D	E	F	H	T	Sugg. List
2190	S	IP-3620	2-1/4"	3/8"	1-1/4"	3/4"	11/32"	1/8"	.050"	\$10.45
2191	S	IP-4420	2-3/4"	3/8"	1-3/16"	3/4"	11/32"	1/8"	.050"	\$10.45
2192	S	IP-5222	3-1/4"	3/8"	1-5/16"	3/4"	11/32"	1/8"	.060"	\$10.45
2193	S	IP-3015-2	1-7/8"	3/8"	15/16"	3/8"	11/32"	1/8"	.050"	\$15.94
5711	S*		5"	1/2"	1-3/16"	1/2"	1/2"		.074"	\$29.00
7813	S		4"	3/8"	1-9/16"	3/4"	13/16"	7/16"	.060"	\$22.46

(\* ) Denotes Heavy Duty Bearing

S=Steel

P=Plastic

### FLUSH FLAT IDLERS

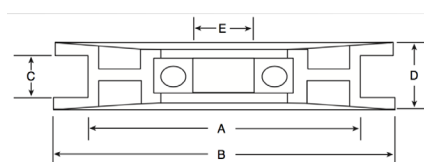

Order No.			A	B	C	D	E	Sugg. List
10140	P	FIP1875-0.75	1-7/8"	2"	3/4"	31/32"	11/16"	\$7.98
10139	P	FIP1875-0.50	1-7/8"	2-1/8"	1/2"	45/64"	11/16"	\$7.43
10138	P	FIP1750-0.75	1-3/4"	2-7/32"	3/4"	15/16"	11/16"	\$7.43
10141	P	FIP2250-0.75	2-1/4"	2-23/32"	3/4"	15/16"	11/16"	\$7.98
10142	P	FIP2500-0.75	2-1/2"	2-31/32"	1"	1-3/16"	11/16"	\$8.25
10143	P	FIP2500-1.00	2-1/2"	2-31/32"	1"	1-3/16"	11/16"	\$8.53
10145	P	FIP2750-0.86	2-3/4"	3-3/16"	23/32"	1-1/16"	11/16"	\$8.53
10144	P	FIP2750-0.75	2-3/4"	3-7/32"	3/4"	15/16"	11/16"	\$8.53
10146	P	FIP2750-1.00	2-3/4"	3-7/32"	1"	1-3/16"	11/16"	\$8.80
2916	S*	Repl 21409		3-1/4"	7/8"		1/2"	\$13.25
10148	P	FIP3000-1.01	3"	3-31/64"	1"	1-3/16"	11/16"	\$9.08
10147	P	FIP3000-0.75	3"	3-1/2"	3/4"	1"	11/16"	\$8.80
10151	P	FIP3500-0.97	3-1/2"	3-31/32"	1"	15/32"	11/16"	\$9.63
10149	P	FIP3120-0.75	3-1/8"	4"	3/4"	1-1/8"	11/16"	\$9.08
2915	S*	Repl 23339		4"	7/8"		1/2"	\$13.75

(\* ) Denotes Heavy Duty Bearing

S=Steel

P=Plastic

***FLUSH FLAT IDLERS (CONTINUED)***

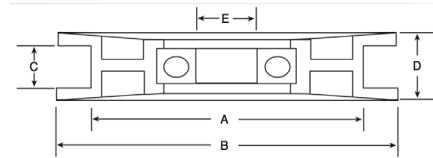

Order No.			A	B	C	D	E	Sugg. List
10150	P	FIP3500-0.75	3-1/2"	4-1/8"	3/4"	1"	11/16"	\$9.08
2917	S*	Repl 23238		4-9/16"	3/4"		1/2"	\$16.50
10152	P	FIP4000-0.72	4"	4-39/64"	23/32"	1-1/16"	11/16"	\$11.72
10154	P	FIP4000-1.00	4"	4-5/8"	1"	1-3/16"	11/16"	\$9.90
10153	P	FIP4000-0.86	4"	4-3/4"	7/8"	1-11/32"	11/16"	\$17.16
3236	S*	Repl 90118		4-3/4"	7/8"		1/2"	\$17.50
10155	P	FIP4500-0.96	4-1/2"	4-31/32"	31/32"	1-1/8"	11/16"	\$10.45
10156	P	FIP5000-1.25	5"	5-1/2"	1-1/4"	1-1/2"	11/16"	\$36.49
10157	P	FIP6000-0.75	6"	6-1/2"	1"	1-9/32"	11/16"	\$16.50

(\*) Denotes Heavy Duty Bearing

S=Steel

P=Plastic

***FLUSH V BELT IDLERS***

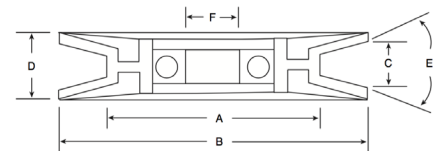

Order No.			A	B	C	D	E	Sugg. List
10128	P	VIP2000-2.112	1-3/8"	2"	3/8"	5/8"	10mm	\$11.74
10129	P	VIP2500-2.740	1-3/4"	2-1/2"	1/2"	3/4"	17mm	\$7.43
10130	P	VIP2875-3.190	1-3/4"	2-7/8"	1/2"	3/4"	17mm	\$7.70
2918	S*	Repl 20613		3"	3/8"		1/2"	\$12.50
10131	P	VIP3000-3.316	1.96"	3"	1/2"	11/16"	17mm	\$7.70
10135	P	VIP3000-3.105	1-51/64"	3"	41/64"	13/16"	17mm	\$7.43
10132	P	VIP3480-3.765	2-37/64"	3-31/64"	1/2"	11/16"	17mm	\$7.98
10133	P	VIP3560-3.585	2-1/2"	3-9/16"	37/64"	25/32"	17mm	\$8.25
10136	P	VIP3470-3.575	2-17/64"	3-37/64"	41/64"	13/16"	17mm	\$8.25
2919	S*	Repl 23211		3-3/4"	1/2"		1/2"	\$18.50
10134	P	VIP4000-4.316	2-5/8"	4"	1/2"	7/8"	17mm	\$8.53
10137	P	VIP4000-4.105	2-51/64"	4"	41/64"	13/16"	17mm	\$9.35

(\*) Denotes Heavy Duty Bearing

S=Steel

P=Plastic

### STEEL V BELT PULLEYS



Order No.	OD	ID	Keyway	Sugg. List
750	2-1/4"	3/8"	1/8"	\$7.88
751	2"	1/2"	1/8"	\$7.88
752	2"	5/8"	3/16"	\$7.88
753	2-1/4"	1/2"	1/8"	\$7.88
754	2-1/4"	5/8"	3/16"	\$7.88
755	2-1/2"	1/2"	1/8"	\$9.50
756	2-1/2"	5/8"	3/16"	\$7.88
757	3"	1/2"	1/8"	\$6.88
758	3"	5/8"	3/16"	\$8.25
759	3"	3/4"	3/16"	\$8.25
760	3-1/4"	1/2"	1/8"	\$7.15
761	3-1/4"	5/8"	3/16"	\$9.25
762	3-1/4"	3/4"	3/16"	\$9.25

Order No.	OD	ID	Keyway	Sugg. List
763	3-1/2"	1/2"	1/8"	\$10.15
764	3-1/2"	5/8"	3/16"	\$10.25
765	3-1/2"	3/4"	3/16"	\$10.25
766	4"	1/2"	1/8"	\$10.25
767	4"	5/8"	3/16"	\$10.25
768	4"	3/4"	3/16"	\$10.25
769	3"	7/8"	3/16"	\$10.25
770	3-1/2"	7/8"	3/16"	\$12.25
771	4"	7/8"	3/16"	\$12.25
772	3"	1"	1/4"	\$12.25
773	3-1/2"	1"	1/4"	\$12.25
774	4"	1"	1/4"	\$12.25

### HEAVY DUTY CAST IRON V BELT PULLEYS



Order No.	OD	ID	Keyway	Sugg. List
5961	2"	1/2"	1/8"	\$20.15
5962	2"	5/8"	3/16"	\$20.15
5963	2"	3/4"	3/16"	\$20.15
5964	2-1/4"	1/2"	1/8"	\$21.95
5965	2-1/4"	5/8"	3/16"	\$21.95
5966	2-1/4"	3/4"	3/16"	\$22.15
5967	2-1/4"	7/8"	3/16"	\$22.25
5969	2-1/2"	5/8"	3/16"	\$28.25
5970	2-1/2"	3/4"	3/16"	\$28.25
5971	2-1/2"	7/8"	3/16"	\$28.25
5973	2-3/4"	5/8"	3/16"	\$28.00
5974	2-3/4"	3/4"	3/16"	\$28.00
5975	2-3/4"	7/8"	3/16"	\$28.25

Order No.	OD	ID	Keyway	Sugg. List
5976	2-3/4"	1"	1/4"	\$28.25
5977	3"	1/2"	1/8"	\$28.95
5978	3"	5/8"	3/16"	\$29.45
5979	3"	7/8"	3/16"	\$29.45
5879	3"	3/4"	3/16"	\$31.75
5880	3"	1"	1/4"	\$31.75
5980	3-1/2"	1/2"	1/8"	\$29.45
2186	3-1/2"	5/8"	3/16"	\$33.55
5982	3-1/2"	3/4"	3/16"	\$31.45
5983	3-1/2"	7/8"	3/16"	\$31.45
5984	3-1/2"	1"	1/4"	\$31.45
5985	4"	1/2"	1/8"	\$31.85
5881	4"	5/8"	3/16"	\$31.75

Order No.	OD	ID	Keyway	Sugg. List
5882	4"	3/4"	3/16"	\$31.75
5986	4"	7/8"	3/16"	\$31.95
5883	4"	1"	1/4"	\$31.75
5884	5"	3/4"	3/16"	\$43.50
5885	5"	1"	1/4"	\$43.50
5886	5-3/4"	5/8"	3/16"	\$45.50
5887	5-3/4"	3/4"	3/16"	\$46.95
5997	6"	1"	1/4"	\$45.85

***OEM DIRECT REPLACEMENT PULLEYS BY SIZE***

Pulleys are in order from OD Smallest to Largest, then ID smallest to largest

 <p>ID 7/8" OD 2-1/4" Height 7/8" Keyway 5/32"</p>	 <p>ID 3/8" OD 2-1/2" Height 1"</p>
<p><b>ORDER #:</b> 5950      <b>SUGG LIST:</b> \$22.55</p>	<p><b>ORDER #:</b> 13622      <b>SUGG LIST:</b> \$17.66</p>
<p>7/8" Crankshaft Pulley. Replaces Snapper 7024596, 7022044. 5/16" coarse set screw.</p>	<p>Idler pulley replaces AYP 165626. Composite plastic Idler pulley. Belt groove 1/2".</p>
 <p>ID 15/32" OD 2-7/8" Height 27/32" Keyway</p>	 <p>ID 21/32" OD 2-7/8" Height 29/32"</p>
<p><b>ORDER #:</b> 7278      <b>SUGG LIST:</b> \$15.89</p>	<p><b>ORDER #:</b> 14240      <b>SUGG LIST:</b> \$14.26</p>
<p>Idler Pulley. Replaces Toro 46-5650. Fits all 21" BBC models.</p>	<p>Idler pulley replaces John Deere AM115460. Fits EZ Trak, LX, GT, X300R and others. Composite. 3/8" belt groove.</p>
 <p>ID 11/16" OD 2-7/8" Height 21/32"</p>	 <p>ID 3/8" OD 3" Height 1-1/8"</p>
<p><b>ORDER #:</b> 10738      <b>SUGG LIST:</b> \$6.45</p>	<p><b>ORDER #:</b> 10396      <b>SUGG LIST:</b> \$18.12</p>
<p>V-Belt idler pulley replaces John Deere GX20286. Also fits Sabre models: 14542GS, 1642HS, 1742HS, 17542HS lawn tractors.</p>	<p>Deck Belt V-Idler pulley replaces AYP 139123. Fits AYP riding mowers.</p>
 <p>ID 3/8" OD 3-1/16" Height 2"</p>	 <p>ID 3/8" OD 3-1/8" Height 1"</p>
<p><b>ORDER #:</b> 14326      <b>SUGG LIST:</b> \$13.89</p>	<p><b>ORDER #:</b> 12891      <b>SUGG LIST:</b> \$13.93</p>
<p>Idler pulley replaces MTD 756-04325. V-Idler pulley.</p>	<p>Idler pulley replaces MTD 756-04224, 756-0981.</p>

# PULLEYS

OEM Pulleys by Size











 <p>ID 21/32" OD 3-11/32" Height 1"</p>	 <p>ID 3/8" OD 3-1/2" Height 1-1/8"</p>
<p><b>ORDER #:</b> 9544      <b>SUGG LIST:</b> \$9.95</p>	<p><b>ORDER #:</b> 9849      <b>SUGG LIST:</b> \$16.40</p>
<p>Idler pulley replaces Murray 690409 7 690407. ID 21/32", OD 3-11/32", Height 1".</p>	<p>Heavy duty Deck Belt V-Idler pulley replaces AYP 139245. Fits AYP &amp; Husqvarna riding mowers.</p>
 <p>ID 3/8" OD 3-1/2" Height 2-1/8"</p>	 <p>ID 3/8" OD 3-1/2" Height 1-5/16"</p>
<p><b>ORDER #:</b> 12644      <b>SUGG LIST:</b> \$17.66</p>	<p><b>ORDER #:</b> 13178      <b>SUGG LIST:</b> \$14.02</p>
<p>Idler pulley replaces AYP 179114.</p>	<p>Idler pulley replaces AYP 194326. Composite Plastic.</p>
 <p>ID 3/8" OD 3-1/2" Height 1-1/2"</p>	 <p>ID 3/8" OD 3-1/2" Height 1-1/6"</p>
<p><b>ORDER #:</b> 13179      <b>SUGG LIST:</b> \$14.02</p>	<p><b>ORDER #:</b> 14259      <b>SUGG LIST:</b> \$8.64</p>
<p>Idler pulley replaces AYP 194327. Composite Plastic.</p>	<p>Flat idler pulley replaces Husqvarna 539-110311. Fits CZ &amp; RZ series, RZ4623 etc &amp; Poulan 460ZX. Also replaces Bluebird 539-110311. Composite.</p>
 <p>ID 11/16" OD 3-5/8" Height 1-3/16"</p>	 <p>ID 3/8" OD 3-7/8" Height 3/4"</p>
<p><b>ORDER #:</b> 10741      <b>SUGG LIST:</b> \$11.02</p>	<p><b>ORDER #:</b> 9376      <b>SUGG LIST:</b> \$17.31</p>
<p>Idler pulley replaces John Deere GY20067. Also fits Sabre models: 14542GS, 1642HS, 1742HS, 17542HS lawn tractors.</p>	<p>Deck Idler pulley replaces AYP 131494. Fits AYP, Sears, Roper.</p>







 <p>ID 3/8" OD 3-7/8" Height 1-1/4"</p>	 <p>ID 3/8" OD 3-7/8" Height 1-9/16"</p>		
<p><b>ORDER #:</b> 11632      <b>SUGG LIST:</b> \$13.45</p>	<p><b>ORDER #:</b> 11634      <b>SUGG LIST:</b> \$20.07</p>		
<p>Idler pulley replaces AYP 173437. Fits 42" Decks from 2000-up.</p>		<p>Idler pulley replaces AYP 177968. Fits 48" Decks from 2001-up.</p>	
 <p>ID 11/16" OD 4" Height 3/4"</p>	 <p>ID 11/16" OD 4" Height 11/16"</p>		
<p><b>ORDER #:</b> 12302      <b>SUGG LIST:</b> \$14.50</p>	<p><b>ORDER #:</b> 12427      <b>SUGG LIST:</b> \$16.75</p>		
<p>Idler pulley replaces Exmark 109-4077. Fits Quest models.</p>		<p>Idler pulley replaces John Deere AM37249.</p>	
 <p>ID 12 pt OD 4" Height 1"</p>	 <p>ID 3/8" OD 4-1/8" Height 27/32"</p>		
<p><b>ORDER #:</b> 11711      <b>SUGG LIST:</b> \$17.05</p>	<p><b>ORDER #:</b> 9856      <b>SUGG LIST:</b> \$23.90</p>		
<p>Spindle pulley replaces Cub Cadet 756-04216. S9G-545 x 12 pt Hex Ch. Fits our 10-14329 spindle.</p>		<p>Idler pulley replaces Snapper 7018574.</p>	
 <p>ID 3/8" OD 4-1/8" Height 1-3/64"</p>	 <p>ID 3/8" OD 4-1/8" Height 1-1/2"</p>		
<p><b>ORDER #:</b> 11144      <b>SUGG LIST:</b> \$26.18</p>	<p><b>ORDER #:</b> 12901      <b>SUGG LIST:</b> \$24.11</p>		
<p>Idler pulley replaces MTD 956-0365. Fits 46" deck &amp; 44" rear discharge deck series 600, 700 &amp; 800. Fits Deck H, used 1985 - 1994. (steel)</p>		<p>Idler pulley replaces Toro 106-2175.</p>	

# PULLEYS

## OEM Pulleys by Size

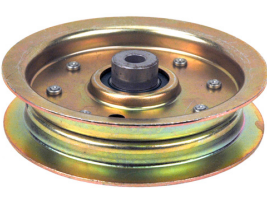

		ID 3/8" OD 4-1/4" Height 3/4"				ID 3/8" OD 4-1/4" Height 11/16"	
<b>ORDER #:</b> 12276		<b>SUGG LIST:</b> \$24.00		<b>ORDER #:</b> 12620		<b>SUGG LIST:</b> \$14.48	
Idler pulley replaces Cub Cadet 01004081.				Idler pulley replaces AYP 146763. Fits 46" decks.			
		ID 3/4" OD 4-1/4" Height 13/16"				ID 3/8" OD 4-1/4" Height 1-1/8"	
<b>ORDER #:</b> 8829		<b>SUGG LIST:</b> \$26.88		<b>ORDER #:</b> 12675		<b>SUGG LIST:</b> \$16.35	
V-Idler pulley replaces Toro 92-7103 & 104974. Fits garden trac-				Idler pulley replaces MTD 756-04129.			
		ID 3/8" OD 4-3/8" Height 1-29/64"				ID 5/8" OD 4-3/8" Height 1"	
<b>ORDER #:</b> 12661		<b>SUGG LIST:</b> \$21.51		<b>ORDER #:</b> 9895		<b>SUGG LIST:</b> \$25.05	
Idler pulley replaces AYP 173901 & 156493. Fits 46" decks.				V-Belt Idler pulley replaces Dixie Chopper 30234, Toro 65-5940. Heavy duty riveted pulley.			
		ID 3/8" OD 4-1/2" Height 1-1/16"				ID 3/8" OD 4-1/2" Height 1-3-16"	
<b>ORDER #:</b> 11633		<b>SUGG LIST:</b> \$17.10		<b>ORDER #:</b> 11635		<b>SUGG LIST:</b> \$32.50	
Idler pulley replaces AYP 175820. Fits 48" Decks from 2000-up.				V-Idler pulley replaces AYP 189993. Fits 48" Decks from 2005-up.			

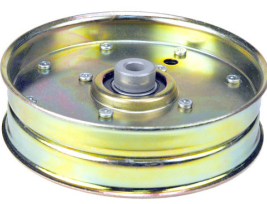
	<p>ID 1/2" OD 4-1/2" Height 1"</p>		<p>ID 5/8" splined OD 4-5/8" Height 7/8"</p>
<p><b>ORDER #:</b> 9378</p>	<p><b>SUGG LIST:</b> \$19.69</p>	<p><b>ORDER #:</b> 9121</p>	<p><b>SUGG LIST:</b> \$8.94</p>
<p>Flat idler pulley replaces Dixon 1687, 539115278. Main drive pulley on Dixon mowers.</p>		<p>Splined pulley replaces AYP 153531. Fits 36" &amp; 46" cut mowers. Double Hex ID.</p>	
	<p>ID 11/16" OD 4-5/8" Height 1"</p>		<p>ID 41/64" splined OD 4-13/16" Height 31/32"</p>
<p><b>ORDER #:</b> 9543</p>	<p><b>SUGG LIST:</b> \$10.95</p>	<p><b>ORDER #:</b> 9148</p>	<p><b>SUGG LIST:</b> \$9.96</p>
<p>Idler pulley replaces Murray 690549.</p>		<p>Steel deck pulley replaces AYP 153532 &amp; 129206. Fits 38" cut mowers. Double Hex ID.</p>	
	<p>ID 5/8" OD 4-7/8" Height 1-3/8"</p>		<p>ID 3/8" OD 4.88" Height 1"</p>
<p><b>ORDER #:</b> 12513</p>	<p><b>SUGG LIST:</b> \$20.07</p>	<p><b>ORDER #:</b> 12277</p>	<p><b>SUGG LIST:</b> \$32.15</p>
<p>Spindle pulley replaces AYP 174375. Fits 48" decks.</p>		<p>Idler pulley replaces Cub Cadet 01004101.</p>	
	<p>ID 3/8" OD 5" Height 1-1/8"</p>		<p>ID 3/8" OD 5" Height 1-7/16"</p>
<p><b>ORDER #:</b> 12275</p>	<p><b>SUGG LIST:</b> \$29.15</p>	<p><b>ORDER #:</b> 14090</p>	<p><b>SUGG LIST:</b> \$20.81</p>
<p>Idler pulley replaces Cub Cadet 756-3045.</p>		<p>Idler pulley replaces MTD/Cub Cadet 756-3062.</p>	

# PULLEYS

## OEM Pulleys by Size



	<p>ID 9/16" splined OD 5" Height 1-27/64"</p>		<p>ID 11/16" OD 5" Height 1-1/8"</p>
<p><b>ORDER #:</b> 7993</p>	<p><b>SUGG LIST:</b> \$28.50</p>	<p><b>ORDER #:</b> 9772</p>	<p><b>SUGG LIST:</b> \$28.44</p>
<p>Blade spindle pulley (right and left) replaces Murray 92127. Fits 46" front engine rider 14 and 18 hp models 46620B, 46620X15A and 46621X92B.</p>		<p>Idler pulley replaces Exmark 1-603805. Deep V idler pulley fits Lazer Z.</p>	
	<p>ID 11/16" OD 5" Height 1-1/4"</p>		<p>ID 11/16" OD 5" Height 1"</p>
<p><b>ORDER #:</b> 12297</p>	<p><b>SUGG LIST:</b> \$35.60</p>	<p><b>ORDER #:</b> 12419</p>	<p><b>SUGG LIST:</b> \$17.57</p>
<p>Idler pulley replaces Hustler 784504. Fits FasTrak &amp; Mini Fas-Trak.</p>		<p>Idler pulley replaces John Deere AM106627.</p>	
	<p>ID 3/4" splined OD 5" Height 2-1/2"</p>		<p>ID 1-9/16" OD 5" Height</p>
<p><b>ORDER #:</b> 8657</p>	<p><b>SUGG LIST:</b> \$29.66</p>	<p><b>ORDER #:</b> 9708</p>	<p><b>SUGG LIST:</b> \$67.13</p>
<p>Blade spindle pulley replaces MTD 756-0486. Fits 38" &amp; 36" MTD F Deck 600 series tractor. Used on our 10-7156.</p>		<p>Deck pulley (double pulley) replaces MTD 756-0638. Fits yard machines model series 690-699 hydrostatic lawn tractors. Uses our 09-483 bearing.</p>	
	<p>ID 12 point spline OD 5" Height 1"</p>		<p>ID 5/8" splined OD 5-3/16" Height 7/8"</p>
<p><b>ORDER #:</b> 9588</p>	<p><b>SUGG LIST:</b> \$19.50</p>	<p><b>ORDER #:</b> 7180</p>	<p><b>SUGG LIST:</b> \$13.95</p>
<p>Deck pulley replaces MTD 756-0969. Fits 600 series mowers.</p>		<p>Spindle Pulley. Replaces AYP 153535, 129861, 173436, 177865. Fits 42" deck models 7147A29, 7167A29 and 7147B29.</p>	







 <p style="text-align: right;">ID 43/64" OD 5-7/32" Height 1-23/32"</p>	 <p style="text-align: right;">ID 3/8" OD 5-3/8" Height 1-5/8"</p>
<p><b>ORDER #:</b> 11207      <b>SUGG LIST:</b> \$16.50</p>	<p><b>ORDER #:</b> 13175      <b>SUGG LIST:</b> \$25.28</p>
<p>Idler pulley replaces John Deere GY20629. Fits L120, L130 lawn tractors. Fits G110 Garden Tractor.</p>	<p>Idler pulley replaces AYP 196106. Painted version of AYP 197379.</p>
 <p style="text-align: right;">ID 9/16" OD 5-3/8" Height 1/2"</p>	 <p style="text-align: right;">ID 3/8" OD 5-1/2" Height 1-9/16"</p>
<p><b>ORDER #:</b> 10820      <b>SUGG LIST:</b> \$14.95</p>	<p><b>ORDER #:</b> 12061      <b>SUGG LIST:</b> \$26.22</p>
<p>Jackshaft pulley replaces Murray 494199. Fits 42" cut, splined shafts.</p>	<p>Idler pulley replaces AYP 187284.</p>
 <p style="text-align: right;">ID 5/8" OD 5-1/2" Height 59/64"</p>	 <p style="text-align: right;">ID 11/16" OD 5-1/2" Height 1-1/8"</p>
<p><b>ORDER #:</b> 12456      <b>SUGG LIST:</b> \$13.50</p>	<p><b>ORDER #:</b> 10397      <b>SUGG LIST:</b> \$24.93</p>
<p>Spindle pulley replaces AYP 198145. Fits Ayp, Craftsman, Dixon.</p>	<p>Flat Idler pulley replaces Exmark 1-613098. Fits floating deck walkbehind units.</p>
 <p style="text-align: right;">Top ID 1" Bottom ID 1" Top OD 3-1/2" Bottom OD 5-1/2" Height 4-7/8"</p>	 <p style="text-align: right;">Top ID 1" Bottom ID 1" Top OD 3-1/2" Bottom OD 5-1/2" Height 4-5/8"</p>
<p><b>ORDER #:</b> 10185      <b>SUGG LIST:</b> \$39.25</p>	<p><b>ORDER #:</b> 10186      <b>SUGG LIST:</b> \$44.31</p>
<p>Double engine pulley replaces MTD 756-0982B, 753-0635 and 756-0488. Fits model 660-679 riding mowers. Without spacer</p>	<p>Double engine pulley replaces MTD 756-0983B. Fits model 690-699 riding mowers. Without spacer.</p>

# PULLEYS

## OEM Pulleys by Size



	<p>ID 12 point hex OD 5-9/16" Height 5/8"</p>		<p>ID 3/8" OD 5-3/4" Height 1-3/8"</p>
<p><b>ORDER #:</b> 12884</p>	<p><b>SUGG LIST:</b> \$20.02</p>	<p><b>ORDER #:</b> 12613</p>	<p><b>SUGG LIST:</b> \$40.15</p>
<p>Spindle pulley replaces Cub Cadet 756-1188. Fits our 10-12883 Spindle.</p>		<p>Idler pulley replaces MTD 756-3105 / 956-3105. Fits 54" cut decks.</p>	
	<p>ID 1/2" OD 5-3/4" Height 2-23/64"</p>		<p>ID 11/16" OD 5-3/4" Height 2-1/2"</p>
<p><b>ORDER #:</b> 12722</p>	<p><b>SUGG LIST:</b> \$38.00</p>	<p><b>ORDER #:</b> 11815</p>	<p><b>SUGG LIST:</b> \$31.35</p>
<p>Idler pulley replaces Bad Boy 033-5001-00.</p>		<p>Idler pulley replaces Exmark 1-413099.</p>	
	<p>ID 12 point spline OD 5-3/4" Height 1"</p>		<p>ID 9/16" splined OD 6-1/4" Height 2-9/16"</p>
<p><b>ORDER #:</b> 9587</p>	<p><b>SUGG LIST:</b> \$16.07</p>	<p><b>ORDER #:</b> 7995</p>	<p><b>SUGG LIST:</b> \$37.80</p>
<p>Deck pulley replaces MTD 756-0980. Fits 600 series mowers.</p>		<p>Blade spindle pulley replaces Murray 92425. Fits 42" front engine rider 18 hp model 42170X9A</p>	
	<p>ID 5/8" splined OD 6-1/4" Height 7/8"</p>		<p>ID 5/8" OD 6-5/16" Height 5/8"</p>
<p><b>ORDER #:</b> 12378</p>	<p><b>SUGG LIST:</b> \$13.98</p>	<p><b>ORDER #:</b> 12682</p>	<p><b>SUGG LIST:</b> \$13.52</p>
<p>Spindle pulley replaces AYP 195945. Fits newer 42" &amp; 46" decks.</p>		<p>Idler pulley replaces Cub Cadet 756-1227. Fits 42" decks on models LT1000 series 2007 and after. Fits Cub Cadet 618-0624 spindle.</p>	

 <p>ID 21/32" OD 6-3/4" Height 1-3/16"</p>	 <p>ID .985" OD 6-3/4" Height 1"</p>
<p><b>ORDER #:</b> 9864      <b>SUGG LIST:</b> \$29.90</p>	<p><b>ORDER #:</b> 12793      <b>SUGG LIST:</b> \$37.60</p>
<p>Idler pulley replaces Exmark 1-633109. Fits 52", 60" &amp; 72" deck belts on Lazer Z units.</p>	<p>Spindle pulley replaces Exmark 1-653386. Fits Lazer Z CT 52" spindles. ID .985", OD 6-3/4", Height 1".</p>
 <p>ID 3/4" OD 6-7/8" Height 1-27/64"</p>	 <p>ID 19/32" OD 7" Height 7/8"</p>
<p><b>ORDER #:</b> 436      <b>SUGG LIST:</b> \$18.60</p>	<p><b>ORDER #:</b> 11449      <b>SUGG LIST:</b> \$24.55</p>
<p>Deck Spindle Pulley. Replaces Snapper 7018781</p>	<p>Spindle pulley replaces John Deere GX20367. Fits models 14,442GS, 1642GS, 1642HS, 1742HS, 17.542HS Sabre Lawn Tractors.</p>
 <p>ID 5/8" OD 7" Height 1-17/64" Keyway 3/16"</p>	 <p>ID 2-1/4" OD 8" Height 1/2" Mounting Hole 11/32"</p>
<p><b>ORDER #:</b> 7981      <b>SUGG LIST:</b> \$31.95</p>	<p><b>ORDER #:</b> 9397      <b>SUGG LIST:</b> \$24.77</p>
<p>Trans axle pulley replaces Murray 55101. Fits 30" rear engine rider, 8 hp, models 8-35500 &amp; 7-30502.</p>	<p>Drive wheel pulley replaces Toro 51-4160 &amp; Scag 48200. Fits our 08-8241 &amp; 08-8573 wheel assembly.</p>

# Blade Adapters

## BLADE ADAPTERS ..... 190

- » *AYP/Sears/Husqvarna* .....191
- » *Murray*.....191
- » *MTD* .....192

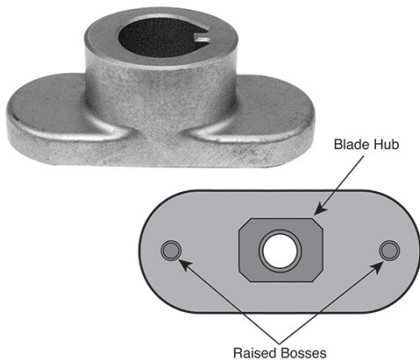
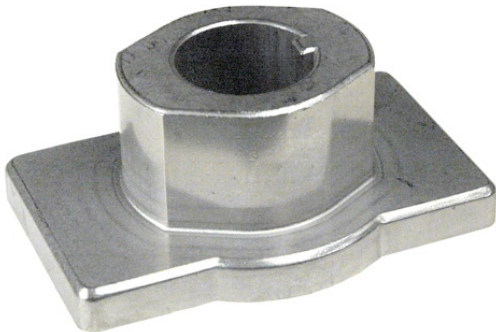

# AYP/SEARS/HUSQVARNA

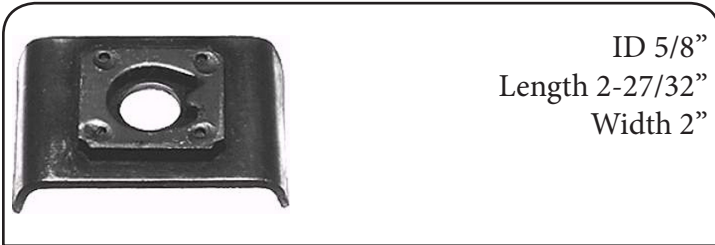

ID 5/8"  
Length 2-27/32"  
Width 2"

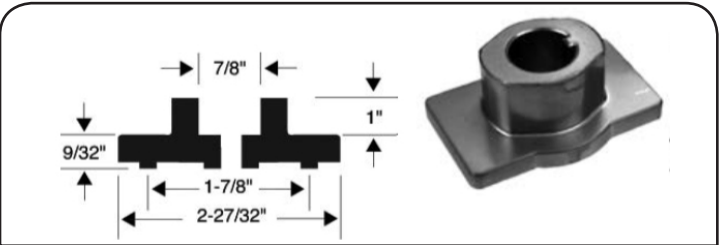

**ORDER #:** 1152

**SUGG LIST:** \$4.94

**ORDER #:** 8752

**SUGG LIST:** \$15.25

Replaces Sears adapter 87711X00, 87711X004, 69226, 84918 and 80104 on most Sears rotary mowers. Black oxide finish. Very popular. Weight 4.5 oz.

Blade adapter replaces AYP 850977. Fits models 1B101C, 3H302C, 2A271D and AYP 2033A59. For 20" & 22" walk behind

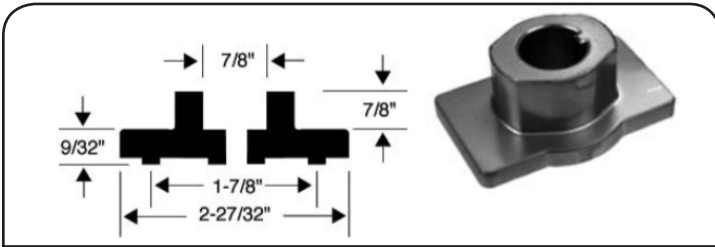

**ORDER #:** 8753

**SUGG LIST:** \$15.25

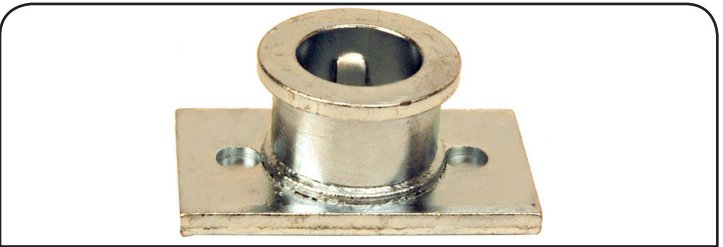

**ORDER #:** 12728

**SUGG LIST:** \$13.83

Blade adapter replaces AYP 851514. Fits models 4H472C, WE9656RD, 3M402A, 44W4B2A and YSC7K402C. For 22" self propelled mowers. Also fits Noma, Sears, Wizard and Husky

Blade Adapter replaces AYP 193707, 184590. 25mm.

# MURRAY

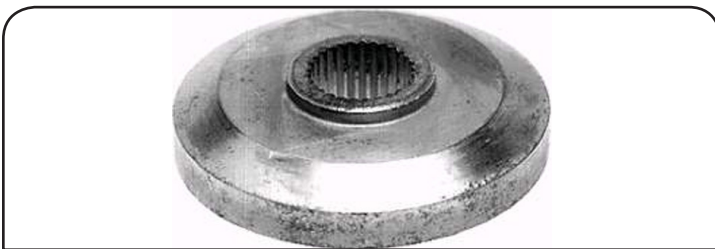

**ORDER #:** 5935

**SUGG LIST:** \$8.95

Spline adapter replaces Murray 92466, 56258 & 91926. Used in our 38" & 42" mulching kits.

# MTD

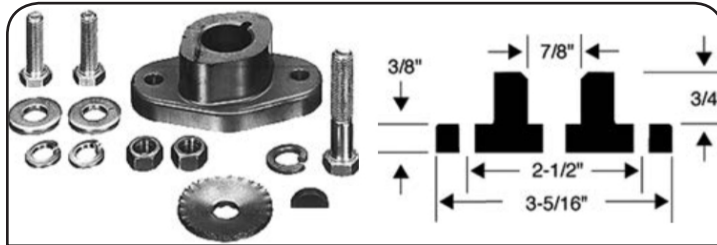

**ORDER #:** 1162

**SUGG LIST:** \$25.05

Replaces MTD 10769. Our 12 clutch assembly. For 7/8" crankshafts. Lowers blade 7/16". Has 5/32" keyway. Uses 1-3/4" Blade bolt & 5/16" - 24 x 1" attachment bolts. Weight: 15 oz.

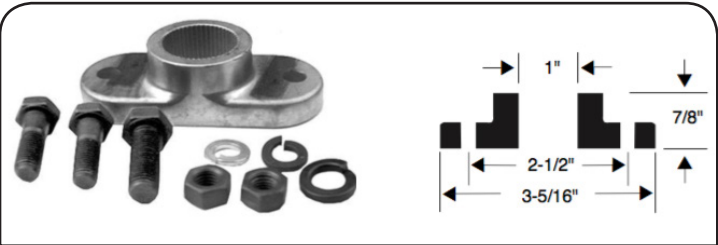

**ORDER #:** 9815

**SUGG LIST:** \$7.42

Blade adapter replaces MTD 753-0583. Fits MTD riders. Includes our 6626 hub.

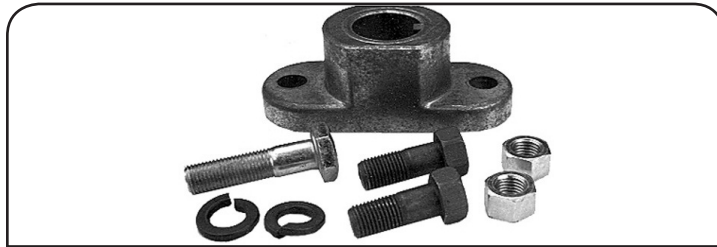

**ORDER #:** 10239

**SUGG LIST:** \$12.69

Blade adapter kit replaces MTD 753-0484. Fits MTD walkbehind mowers. Has 3/16" built in key & 3/8" outside holes.

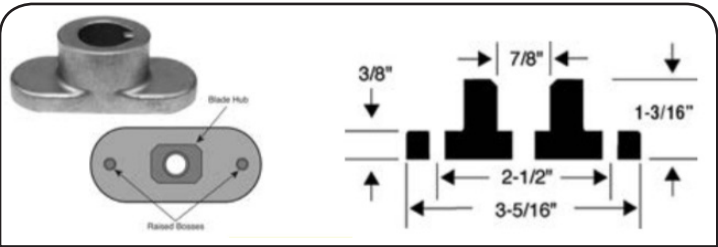

**ORDER #:** 14580

**SUGG LIST:** \$8.35

Blade adapter fits MTD walkbehind mowers. Fits our 6448, 12893, 6438, 6439, 6423, 6450, 6424, 6425 blades

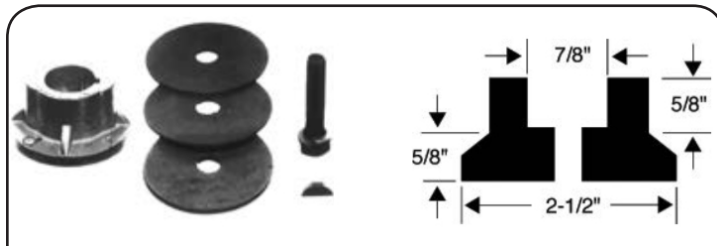

**ORDER #:** 1156

**SUGG LIST:** \$19.00

Our 6 clutch. For 7/8" crankshafts. Lowers blade 5/8". Has 5/32" keyway. Uses 1-3/4" Blade bolt, diameter 2-1/2", weight 12.5 oz.









# Mufflers









# MUFFLERS

Section

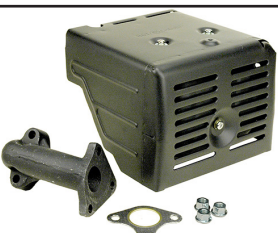
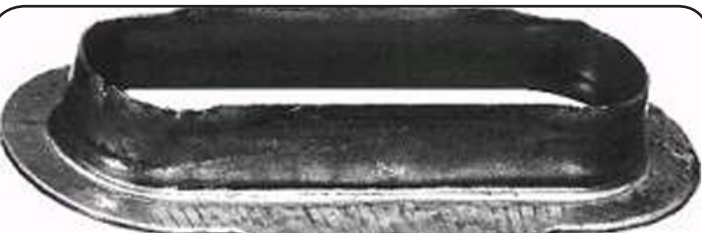

 <p>Pipe Thread 1-5/16" Pipe Length 4-1/2" ID 1" Overall 7-3/4"</p>	
<p><b>ORDER #:</b> 859      <b>SUGG LIST:</b> \$19.25</p>	<p><b>ORDER #:</b> 8003      <b>SUGG LIST:</b> \$36.50</p>
<p>Muffler replaces Briggs &amp; Stratton 393232, 299477, MTD 600 Rider (11 hp).</p>	<p>Muffler replaces B&amp;S 491413. Low-tone muffler for 10 thru 12-1/2 hp Horiz. &amp; Vert. engines.</p>
	 <p>Pipe 3/4"</p>
<p><b>ORDER #:</b> 891      <b>SUGG LIST:</b> \$14.95</p>	<p><b>ORDER #:</b> 1269      <b>SUGG LIST:</b> \$13.95</p>
<p>Muffler replaces Wheel Horse 110774, 110771, Roper 101273- M, Murray 90330SE, Western International 54766, 54765. With bolts and heat shield. For B&amp;S (10 &amp; 11 hp). 1-7/8" bolt center.</p>	<p>Muffler Replaces Briggs &amp; Stratton 393010. Painted, low-tone, two-step type. Fits 9, 9B, 9F, 9R, 100200, 130200, 131200 (5 hp horizontal); 170499, 170700, 171700, 171706 (7 hp horiz.) &amp; (8 hp horiz.).</p>
 <p>Plated Pipe 1/2" Diameter 2-1/2" Height 2-1/2"</p>	 <p>For 1" Pipe Pipe Thread 1" ID 1-1/4"</p>
<p><b>ORDER #:</b> 1272      <b>SUGG LIST:</b> \$6.25</p>	<p><b>ORDER #:</b> 1277      <b>SUGG LIST:</b> \$14.95</p>
<p>Muffler replaces Briggs &amp; Stratton 394569 &amp; 298830. Fits 82500 to 92599, 92900 series (3.5 hp vertical), 93500 series. Also fits Tecumseh and Clinton (2-4 hp).</p>	<p>Muffler replaces Briggs &amp; Stratton 392989, 299477, 393232, (8- 16 hp). Tecumseh 32043B and Kohler No. 275679. Also fits Wisconsin &amp; Gravely. Fits many John Deere, &amp; Wheel Horse</p>
	
<p><b>ORDER #:</b> 1278      <b>SUGG LIST:</b> \$12.95</p>	<p><b>ORDER #:</b> 1283      <b>SUGG LIST:</b> \$21.95</p>
<p>Muffler replaces Briggs &amp; Stratton 493936, 494585, 493936, 297274. Painted black. Bolt-on type with deflector and screw. Fits Briggs &amp; Stratton 100900 series (4-8 hp).</p>	<p>Muffler replaces Briggs &amp; Stratton 391313. Low-tone, square, bolt-on type. Fits vertical and horizontal engine series. 100000 and up (5, 7 &amp; 8 hp) except 110000 series. Comes as pictured.</p>

 <p>Pipe 3/4"</p>	 <p>Pipe 3/4"</p>
<p><b>ORDER #:</b> 12296</p>	<p><b>SUGG LIST:</b> \$9.65</p>
<p>Muffler for B/S. (bagged)</p>	<p><b>ORDER #:</b> 2297</p> <p><b>SUGG LIST:</b> \$3.55</p> <p>Deflector replaces Briggs &amp; Stratton 393757. Can be used on our muffler 892 and 1283. Fits models 170,000 &amp; 190,000 series, 5-8 hp units.</p>
	 <p>For 1" Pipe ID 1-9/16"</p>
<p><b>ORDER #:</b> 2284</p>	<p><b>SUGG LIST:</b> \$23.42</p>
<p>Muffler replaces Tecumseh 35771/33697A. Painted, bolt-on type. Female .895" "D" hole pipe. Fits H40, H50, H60, H70, HS50, LAV50, TVS120, TVS75, TVS90, TVS105, TVXL105 series.</p>	<p><b>ORDER #:</b> 2285</p> <p><b>SUGG LIST:</b> \$26.47</p> <p>Muffler replaces Kohler 45-068-01.</p>
 <p>Inlet ID 1-3/8" Outlet ID 1-3/8" Length 11-1/2"</p>	
<p><b>ORDER #:</b> 8284</p>	<p><b>SUGG LIST:</b> \$72.21</p>
<p>Muffler replaces Kohler 237550. Fits 7, 10 &amp; 12 hp engines. Also replaces Cub Cadet 393840-R91 garden tractors.</p>	<p><b>ORDER #:</b> 9577</p> <p><b>SUGG LIST:</b> \$65.96</p> <p>Muffler replaces Honda 18310-ZF1-000. Fits 5.5 hp engines. Model GX160. Heat shield included.</p>
	
<p><b>ORDER #:</b> 14449</p>	<p><b>SUGG LIST:</b> \$79.98</p>
<p>Muffler pipe replaces Honda 18310-ZE2-W61. Fits GX340, GX390, muffler (100 db) for 11 &amp; 13 hp engines with heat shield.</p>	<p><b>ORDER #:</b> 2955</p> <p><b>SUGG LIST:</b> \$0.99</p> <p>Exhaust Sleeve, replaces Lawn-Boy 602717.</p>

# MUFFLERS

Section



**ORDER #:** 1286

**SUGG LIST:** \$2.25

**ORDER #:** 897

**SUGG LIST:** \$3.95

1/2" Muffler Lock Nut replaces Briggs & Stratton 691720, 220859.

1" Muffler Lock Nut replaces Briggs & Stratton 691808, 261564.