

PARKER

HOURS
Monday - Friday
8 a.m. - 5 p.m.

BROTHERS, INC.

A REPUTATION OF SERVICE SINCE 1958

Buyers' Guide November 2014

**Expanded
Product Solutions
To Meet Every
Need...**

OILS/LUBRICANTS/SERVICE STATION/ AUTOMOTIVE
COMMERCIAL/INDUSTRIAL/MANUFACTURING SUPPLIES

4450 WEST PANOLA RD
ELLENWOOD, GA 30294-2799
PHONE 770-474-1286 FAX 770-474-2750

We're only a phone call away.

PRICES AS OF 11/1/14
PRICES SUBJECT TO CHANGE WITHOUT NOTICE

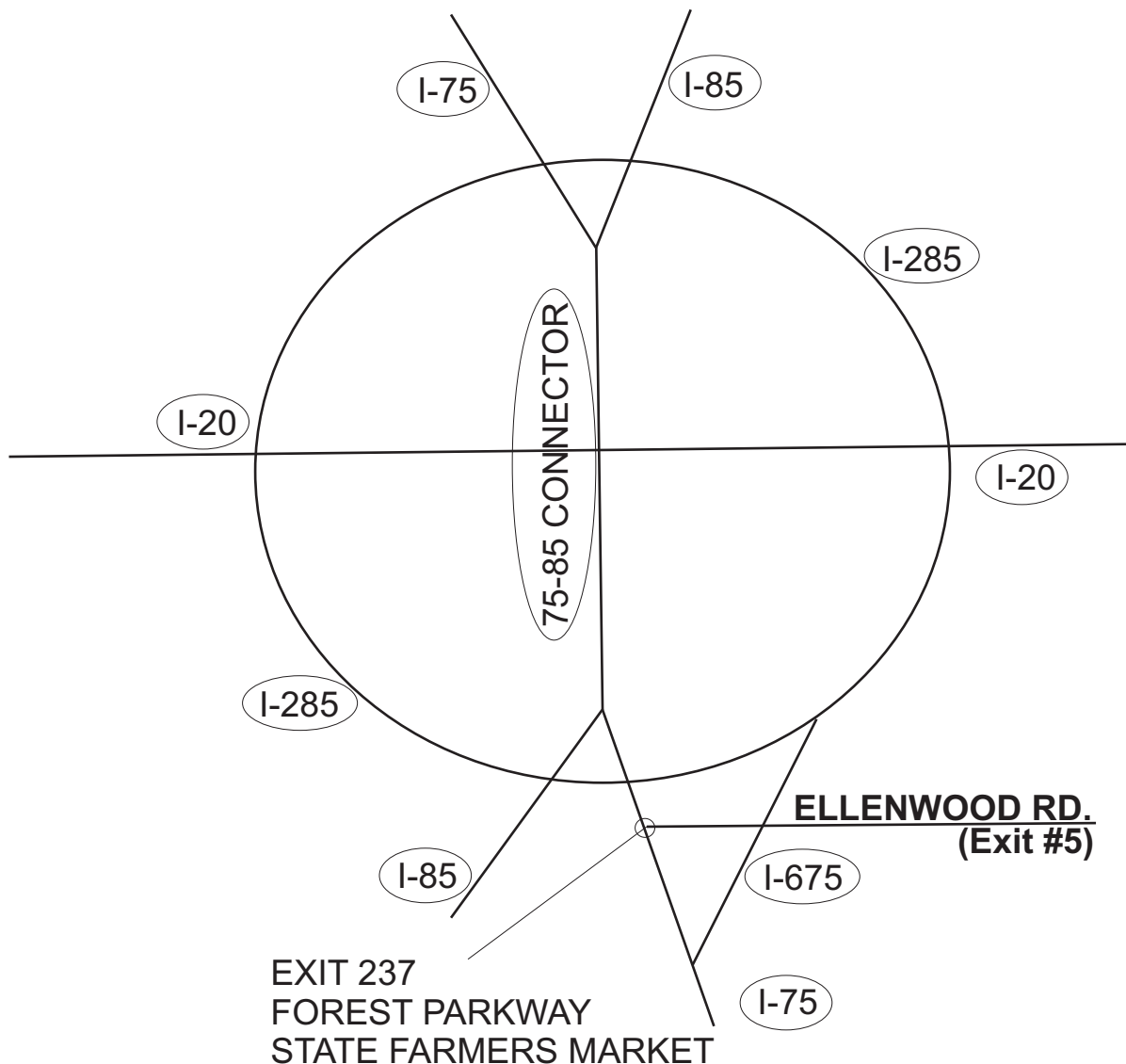

Parker Brothers pick-up desk is open Monday thru Friday 7:30a.m. to 4:30p.m. Call or fax your order in and we will have it waiting for you.
 Phone (770)474-1286 Fax (770)474-2750.

Directions

From the NORTH

Take I-285 to I-675 south. Take exit (#5) Ellenwood Rd. Turn left. Go about 4 miles and we are the last building on the right

From the SOUTH

Take I-75 north to I-675 north. Take exit(#5) Ellenwood Rd. Turn right. Go about 4 miles and we are the last building on the right

i.e. Forest Parkway, Ellenwood Rd., And West Panola Rd. are all the same road.

PARKER, BROTHERS, INC.

OILS/LUBRICANTS/SERVICE STATION/ AUTOMOTIVE
COMMERCIAL/INDUSTRIAL/MANUFACTURING SUPPLIES

4450 WEST PANOLA RD

ELLENWOOD , GA 30294-2799

PHONE 770-474-1286 FAX 770-474-2750

To Our Valued Customers :

Parker Brothers is a 50+ year old, family owned and operated company whose number one goal has always been to provide our customers with the very best service and products at the lowest price possible.

We appreciate your business and are constantly looking for ways to save you money.

If you have any questions or comments, please call Parker Brothers, Monday thru Friday 7:30 a.m. to 4:30 p.m at 770-474-1286.

Our hope is that you will find the things you need to help your business run more efficiently and productively with the aid of this catalog.

WE APPRECIATE YOUR BUSINESS

TABLE OF CONTENTS

LUBRICANTS



Section 1 Pages 1-1 thru 1-22

PASSENGER CAR MOTOR OIL...HEAVY DUTY MOTOR OIL...SYNTHETIC MOTOR OIL...HI PERFORMANCE MOTOR OIL...INDUSTRIAL MOTOR OIL...AUTOMOTIVE TRANSMISSION FLUID...AUTOMOTIVE GEAR OIL...GREASE...TRANS-HYDRAULIC FLUID...HYDRAULIC FLUID...INDUSTRIAL GEAR OIL...AIR COMPRESSOR OIL...REFRIGERATION OIL...TURBINE OIL...AVIATION LUBRICANTS...MARINE LUBRICANTS...2-CYCLE OIL...BAR AND CHAIN OIL...FOOD GRADE LUBRICANTS...WAY OIL...TOOL OIL...METAL WORKING FLUIDS...SPINDLE OIL...ELECTRICAL OIL...HEAT TRANSFER OIL...TEXTILE OIL...MISCELLANEOUS OIL...BRAKE FLUID...POWER STEERING FLUID...ANTIFREEZE...OIL ANALYSIS...MISCELLANEOUS OIL PRODUCTS

PAPER PRODUCTS



Section 2 Pages 2-1 thru 2-4

BATHROOM TISSUE...TOILET SEAT PROTECTORS...FACIAL TISSUE...KITCHEN TOWELS...HAND TOWELS...WIPERS...DISPENSERS...BAGS...FOOD SERVICE...MISCELLANEOUS PAPER...COVERALLS

CLEANING SUPPLIES



Section 3 Pages 3-1 thru 3-9

HEAVY DUTY HAND CLEANER...LIGHT DUTY HAND CLEANER...ANTISEPTIC HAND CLEANER...HAND WIPES...HAND CREAM...BODY WASH...SOAP DISPENSERS...CLEANERS AND DISINFECTANTS...MULTI-PURPOSE CLEANERS...FURNITURE POLISH...GLASS CLEANERS...ODOR CONTROL...BOWL CLEANERS...FLOOR PRODUCTS...SPECIALTY CLEANERS...BROOMS...DUST PANS...RAGS...MOPPING EQUIPMENT...DUST MOPS...SQUEEGEES...BRUSHES...HANDLES...SPRAY BOTTLES

AUTO DETAIL SUPPLIES



Section 4 Pages 4-1 thru 4-5

SOAP...MULTI-PURPOSE CLEANER...DEGREASER...TIRE CLEANER...WHEEL CLEANER...SPECIALTY CLEANER...WINDSHIELD TREATMENTS...AIR FRESHENERS...TIRE AND VINYL DRESSING...WAX...POLISH...RUBBING COMPOUNDS/BUFFING PADS...WATER HOSES AND NOZZLES...BUCKETS AND CHAMOIS...BRUSHES...HANDLES

AUTO//INDUSTRIAL CHEMICALS



Section 5 Pages 5-1 thru 5-11

PENETRANTS...LUBRICANTS...SPRAY CARBURETOR CLEANER...DIP CARBURETOR CLEANER...FUEL INJECTOR CLEANER SYSTEM...INTAKE SYSTEM CLEANER...GAS TREATMENT...DIESEL FUEL CONDITIONER...BRAKE SUPPLIES...CONTACT/ELECTRIC MOTOR CLEANER...PARTS WASHING FLUID...VAT STRIPPERS...STARTING FLUID...WINDSHIELD WASHER SOLVENT...BATTERY PRODUCTS...COOLING SYSTEM PRODUCTS...TRANSMISSION PRODUCTS...ENGINE TREATMENTS...AIR CONDITIONING PRODUCTS...MISCELLANEOUS AUTOMOTIVE PRODUCTS...INDUSTRIAL CLEANERS AND DEGREASERS...MISCELLANEOUS INDUSTRIAL PRODUCTS

ADHESIVES & ABRASIVES



Section 6 Pages 6-1 thru 6-13

GASKET MAKERS AND SEALANTS...GASKET REMOVERS...THREADLOCKERS...PIPE AND THREAD SEALANTS...SPECIALIZED REPAIR...GLUES AND EPOXIES...AUTOMOTIVE ADHESIVES...ADHESIVE REMOVERS...DECAL REMOVERS...AUTOMOTIVE SEALERS...APPLICATOR GUNS...TAPE...PLASTIC WRAP...SAND PAPER...ABRASIVE ROLLS...GRINDING DISC...MISCELLANEOUS ABRASIVES...SCOTCH-BRITE PADS...SPECIALTY CLEANING AND STRIPPING DISC...CUT OFF WHEELS

TIRE SUPPLIES



Section 7 Pages 7-1 thru 7-11

PATCHES...PATCHING ACCESSORIES...PLUGS...PLUGGING ACCESSORIES...PLUG-N-PATCH...REPAIR KITS...TIRE VALVES, CORES, AND CAPS...VALVE TOOLS...AIR CHUCKS...TIRE PRESSURE GAUGES...INFLATOR GAUGES & REPAIR PARTS...FLAT REPAIR...MISCELLANEOUS TIRE SUPPLIES...ALIGNMENT SHIMS...WHEEL WEIGHT TOOL...WHEEL WEIGHTS

AIR HOSES AND FITTINGS

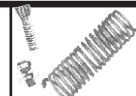

Section 8 Pages 8-1 thru 8-14

AIR HOSES...HOSE FITTINGS...AIR COUPLERS...BLOW GUNS...WATER SUPPLIES...FILTERS, REGULATORS, AND LUBRICATORS...AIR COUPLER INTERCHANGE

TABLE OF CONTENTS

FLUID MANAGEMENT



Section 9 Pages 9-1 thru 9-14

CHEMICAL PUMPS...FUEL PUMPS...MANUAL OIL PUMPS...AIR OPERATED OIL PUMPS, ETC....ELECTRIC OIL PUMPS...GREASE GUNS...MANUAL GREASE PUMPS...AIR OPERATED GREASE PUMPS...GREASE DELIVERY ACCESSORIES...DRAIN PANS...OIL CANS...FUNNELS...FUEL STORAGE...FUEL NOZZLES...HOSE ASSEMBLIES...ACCESSORIES

ELECTRICAL SUPPLIES



Section 10 Pages 10-1 thru 10-9

FUSES...FUSE HOLDERS...CIRCUIT BREAKERS...FUSE ASSORTMENTS...WIRE...ELECTRICAL CONNECTORS AND TERMINALS...ELECTRICAL TERMINAL ASSORTMENTS...BATTERY SUPPLIES...WIRE WEATHERPROOFING...WIRE MANAGEMENT...WIRE MARKERS

SAFETY SUPPLIES



Section 11 Pages 11-1 thru 11-6

ABSORBENTS...GLOVES...EYE PROTECTION...BOOTS...RAIN GEAR...BACK BRACES...COVERALLS...DUST MASK...EAR PLUGS...APRONS AND VESTS...HAIRNETS...KNEE PADS...HARD HATS...BUILDING SAFETY...TRAFFIC SAFETY...GATORADE

HARDWARE



Section 12 Pages 12-1 thru 12-10

FASTENERS...FASTENER ASSORTMENTS...PAINT BRUSHES...SPRAY PRIMER...SPRAY PAINT...CAULK...LIGHTING...BATTERIES...TRAILER ACCESSORIES...STRAPS AND TARPS...DRILL BITS...SHOVELS AND SCRAPERS...PACKAGING MATERIALS...SPRAYERS...WEED KILLER AND INSECT REPELLENT...MISCELLANEOUS PRODUCTS...SERVICE STATION HARDWARE

SHOP TOOLS



Section 13 Pages 13-1 thru 13-3

ELECTRICITY TOOLS...EXTENSION CORDS AND DROP LIGHTS...COMPRESSION TESTERS...ANTIFREEZE TESTERS...RAZOR BLADES...MISCELLANEOUS TOOLS

AUTOMOTIVE PARTS



Section 14 Pages 14-1 thru 14-24

HOSE CLAMPS...FLASHERS...WINDSHIELD WIPERS...GREASE FITTINGS...BULBS...SPARK PLUGS...FILTERS...BALDWIN FILTERS...GATES PRODUCTS...STANT THERMOSTATS AND CAPS...MUFFLER CLAMPS...BATTERIES...DRAIN PLUGS AND GASKETS...SMALL PARTS ASSORTMENTS

INDEX



Section 15 Pages 15-1 thru 15-4

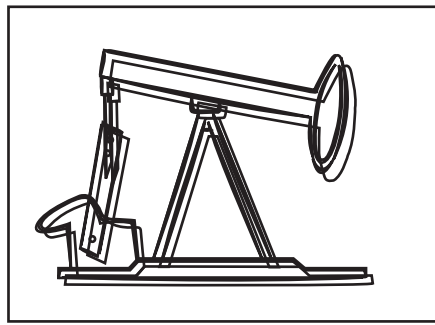

LUBRICANTS

PASSENGER CAR MOTOR OIL
HEAVY DUTY MOTOR OIL
SYNTHETIC MOTOR OIL
HI PERFORMANCE MOTOR OIL
INDUSTRIAL MOTOR OIL
AUTOMOTIVE TRANSMISSION FLUID
AUTOMOTIVE GEAR OIL
GREASE
TRANS-HYDRAULIC FLUID
HYDRAULIC FLUID
INDUSTRIAL GEAR OIL
AIR COMPRESSOR OIL
REFRIGERATION OIL
TURBINE OIL
AVIATION LUBRICANTS
MARINE LUBRICANTS
2-CYCLE OIL
BAR AND CHAIN OIL
FOOD GRADE LUBRICANTS
WAY OIL
TOOL OIL
METAL WORKING FLUIDS
SPINDLE OIL
ELECTRICAL OIL
HEAT TRANSFER OIL
TEXTILE OIL
MISCELLANEOUS OIL
BRAKE FLUID
POWER STEERING FLUID
ANTIFREEZE
OIL ANALYSIS
MISCELLANEOUS OIL PRODUCTS

LUBRICANTS



PASSENGER CAR MOTOR OIL



FormulaShell Motor Oils

SAE5W-20, 5W-30, 10W-30, 10W-40, 20W-50, 30WT and 40WT Motor Oils

FormulaShell™ 5W-30, 10W-30 and 10W-40 Motor Oils are energy conserving oils. Offered in six viscosity grades, the 5W-30 grade is generally preferred in late model 4- and small 6-cylinder gasoline engines. The SAE 5W-30 is also an excellent choice for all engines at very low ambient temperatures where cold starting and rapid oil flow are major considerations. The 10W-30 grade is preferred for larger 6-cylinder and V-8 engines, and it can be used in all engines where an API SL oil is recommended. The 10W-40 grade is still a popular multigrade oil. All oils meet API service classification SM.

SHE:5W20-C	MOTOR OIL..12 / 1 QT	\$ 37.27
SHE:5W20-D	MOTOR OIL..55 GAL	\$ 672.10
SHE:5W30-C	MOTOR OIL..12 / 1 QT	\$ 37.27
SHE:5W30-D	MOTOR OIL..55 GAL	\$ 594.96
SHE:10W30-C	MOTOR OIL..12 / 1 QT	\$ 37.27
SHE:10W30-P	MOTOR OIL..5 GAL	\$ 63.90
SHE:10W30-D	MOTOR OIL..55 GAL	\$ 555.56
SHE:10W40-C	MOTOR OIL..12 / 1 QT	\$ 37.27
SHE:10W40-D	MOTOR OIL..55 GAL	\$ 735.10
SHE:20W50-C	MOTOR OIL..12 / 1 QT	\$ 56.56
SHE:20W50-D	MOTOR OIL..55 GAL	\$ 725.01
SHE:30WT-C	MOTOR OIL..12 / 1 QT	\$ 46.38
SHE:30WT-D	MOTOR OIL..55 GAL	\$ 711.42



P B O
Parker Brothers Oil

Other Brands

PBO

PBO:5W20-D	MOTOR OIL..55 GAL	\$ 482.58
PBO:5W30-D	MOTOR OIL..55 GAL	\$ 482.58
PBO:10W30-D	MOTOR OIL..55 GAL	\$ 470.75



MILE MASTER

OIL:M M -5W20-C	MOTOR OIL..12 / 1 QTS	\$ 31.90
OIL:M M -5W30-C	MOTOR OIL..12 / 1 QTS	\$ 31.90
OIL:M M -10W30-C	MOTOR OIL..12 / 1 QTS	\$ 31.90
OIL:M M -10W40-C	MOTOR OIL..12 / 1 QTS	\$ 31.90
OIL:M M -30WT-C	MOTOR OIL..12 / 1 QTS	\$ 31.90



SERVICE PRO

SPRO:5W20-D	MOTOR OIL..55 GAL	\$ 522.82
SPRO:5W30-D	MOTOR OIL..55 GAL	\$ 503.46
SPRO:10W30-P	MOTOR OIL..5 GAL	\$ 57.88
SPRO:10W30-D	MOTOR OIL..55 GAL	\$ 526.32
SPRO:30WT-C	MOTOR OIL..12 / 1 QTS	\$ 38.46

MYSTIK

MYS:10W30-P	MOTOR OIL..5 GAL	\$ 58.40
-------------	------------------	----------

CHEVRON

CHE:5W30-C	SUPREME MOTOR OIL..12 / 1 QT	\$ 33.84
------------	------------------------------	----------

Castrol

KENDALL

KEN:10W40-C	PASSENGER CAR MOTOR OIL..12 / 1 QT	\$ 37.56
-------------	------------------------------------	----------

HAVOLINE

HAV:5W20-C	MOTOR OIL..12 / 1 QT	\$ 41.10
HAV:5W30-C	MOTOR OIL..12 / 1 QT	\$ 41.10
HAV:10W30-C	MOTOR OIL..12 / 1 QT	\$ 43.31
HAV:10W40-C	MOTOR OIL..12 / 1 QT	\$ 52.91
HAV:20W50-C	MOTOR OIL..12 / 1 QT	\$ 41.10
HAV:30HD-C	MOTOR OIL..12 / 1 QT	\$ 41.10



PENZOIL

PEN:10W30-C	MOTOR OIL..12 / 1 QT	\$ 56.70
-------------	----------------------	----------

VALVOLINE

VAL:5W20-C	5W20 MOTOR OIL..12 / 1 QT	\$ 49.72
VAL:10W30-C	10W30 MOTOR OIL..12 / 1 QT	\$ 49.72
VAL:10W40-C	10W40 MOTOR OIL..12 / 1 QT	\$ 50.21
VAL:20W50-C	20W50 MOTOR OIL..12 / 1 QT	\$ 63.98





LUBRICANTS

HEAVY DUTY MOTOR OIL

Parker Brothers
gladly accepts
Visa, Mastercard
Discover &
American Express



Shell ROTELLA® T Multigrade Oils

Shell ROTELLA T Multigrade SAE 15W-40 is Shell's premium quality, heavy-duty multigrade oil for all-season use in diesel powered or a mix of gasoline and diesel powered vehicles and equipment. Over the past 25 years, this product has become the best selling heavy-duty multigrade oil in the U.S., with a rich heritage as the technology leader in terms of engine testing and proven field performance. All oils meet API service classification SL,CF,CF-4,CG-4,CH-4, CJ-4

SHE:R-T-10W30-C	HEAVY DUTY MOTOR OIL..12 / 1QT	\$ 51.09
SHE:R-T-10W30-3G	HEAVY DUTY MOTOR OIL..3 / 1GAL	\$ 54.79
SHE:R-T-10W30-D	HEAVY DUTY MOTOR OIL..55 GAL	\$ 813.67
SHE:R-T-15W40-C	HEAVY DUTY MOTOR OIL..12 / 1QT	\$ 57.19
SHE:R-T-15W40-3G	HEAVY DUTY MOTOR OIL..3 / 1GAL	\$ 49.49
SHE:R-T-15W40-P	HEAVY DUTY MOTOR OIL..5 GAL	\$ 76.50
SHE:R-T-15W40-T3-D	HEAVY DUTY MOTOR OIL..55 GAL	\$ 764.09

Shell ROTELLA® T Single Grade Oils

Shell ROTELLA T Single Grade Oils have been performance proven in diesel and mixed diesel/gasoline on-highway truck fleets for over 3 billion miles. These engine oils satisfy a wide range of heavy-duty diesel manufacturers' specifications of Detroit Diesel to the high detergency requirements of Caterpillar.

SHE:R-T-10WT-P	HEAVY DUTY MOTOR OIL..5 GAL	\$ 75.98
SHE:R-T-10WT-D	HEAVY DUTY MOTOR OIL..55 GAL	\$ 694.98
SHE:R-T-20WT-D	HEAVY DUTY MOTOR OIL..55 GAL	\$ 777.21
SHE:R-T-30WT-C	HEAVY DUTY MOTOR OIL..12 / 1QT	\$ 50.89
SHE:R-T-30WT-G	HEAVY DUTY MOTOR OIL..3 / 1GAL	\$ 51.52
SHE:R-T-30WT-D	HEAVY DUTY MOTOR OIL..55 GAL	\$ 678.32
SHE:R-T-40WT-C	HEAVY DUTY MOTOR OIL..12 / 1QT	\$ 48.05
SHE:R-T-40WT-3G	HEAVY DUTY MOTOR OIL..3 / 1GAL	\$ 46.34
SHE:R-T-40WT-D	HEAVY DUTY MOTOR OIL..55 GAL	\$ 720.72

S H E L L
R O T E L L A
W I T H
X L A
E X T E N D E D L I F E
A D D I T I V E S A N D

Mystik® Premium Fleet Motor Oils

Mystik® Premium Fleet Motor Oils are excellent high performance motor oils for naturally aspirated, supercharged, and turbocharged diesel and four-stroke gasoline engines. They are blended from selected premium base stocks and a balanced additive system to provide the superior soot-handling and wear protection demanded by modern heavy-duty diesel engines. Premium Fleet motor oils meet or exceed the performance requirements of the major heavy-duty diesel and gasoline engine manufacturers, including those found in off-highway, farm, and construction equipment. Premium Fleet Motor Oils are also the first choice for engines running on "sour" natural gas or other similar fuels that contain high levels of hydrogen disulfide (HeS). All oils meet API service classification SL,CF,CF-2,CF-4,CG-4,CH-4

MYS:10WT-P	HEAVY DUTY MOTOR OIL..5 GAL	\$ 52.99
MYS:10WT-D	HEAVY DUTY MOTOR OIL..55 GAL	\$ 525.61
MYS:20WT-P	HEAVY DUTY MOTOR OIL..5 GAL	\$ 50.69
MYS:20WT-D	HEAVY DUTY MOTOR OIL..55 GAL	\$ 476.74
MYS:30WT-D	HEAVY DUTY MOTOR OIL..55 GAL	\$ 513.37
MYS:40WT-D	HEAVY DUTY MOTOR OIL..55 GAL	\$ 482.69



LUBRICANTS



HEAVY DUTY MOTOR OIL

Mystik® JT-8® Super Heavy Duty Motor Oils

Mystik® JT-8® Super Heavy Duty Motor Oils are value-added lubricants with a carefully balanced premium additive system that will give outstanding deposit control, minimize sludge and varnish, and control wear under the most severe service conditions. Formulated to provide the superior soot-handling and wear protection demanded by modern heavy duty diesel engines, they will help maintain long-term low emission performance. Mystik® JT-8® Super Heavy Duty Motor Oils are recommended for commercial over-the-road fleets, construction equipment, buses, automobiles, and other similar gasoline- or diesel-powered applications where a premium quality engine oil is required. Also recommended for LPG and CNG conversion engines in all types of service, and natural gas engines operating on sour gas or under other severe service conditions. All oils meet API service classification SL,CF,CF-2,CF-4,CG-4,CH-4



MYS:JT8-5W20-C	HEAVY DUTY MOTOR OIL..12 / 1QT	\$ 42.20
MYS:JT8-5W20-D	HEAVY DUTY MOTOR OIL..55 GAL	\$ 763.29
MYS:JT8-5W30-C	HEAVY DUTY MOTOR OIL..12 / 1QT	\$ 44.87
MYS:JT8-5W30-D	HEAVY DUTY MOTOR OIL..55 GAL	\$ 767.00
MYS:JT8-10W30-C	HEAVY DUTY MOTOR OIL..12 / 1QT	\$ 41.47
MYS:JT8-10W30-4G	HEAVY DUTY MOTOR OIL..4 / 1GAL	\$ 63.45
MYS:JT8-10W30-P	HEAVY DUTY MOTOR OIL..5 GAL	\$ 72.44
MYS:JT8-10W30-D	HEAVY DUTY MOTOR OIL..55 GAL	\$ 736.56
MYS:JT8-15W50-C	HEAVY DUTY MOTOR OIL..12 / 1QT	\$ 42.69
MYS:JT8-15W50-4G	HEAVY DUTY MOTOR OIL..4 / 1GAL	\$ 57.13
MYS:JT8-15W50-2G	HEAVY DUTY MOTOR OIL..3 / 2 GAL	\$ 85.46
MYS:JT8-15W50-P	HEAVY DUTY MOTOR OIL..5 GAL	\$ 72.44
MYS:JT8-15W50-D	HEAVY DUTY MOTOR OIL..55 GAL	\$ 770.73
MYS:JT8-15W40-C	HEAVY DUTY MOTOR OIL..12 / 1QT	\$ 42.69
MYS:JT8-15W40-4G	HEAVY DUTY MOTOR OIL..4 / 1GAL	\$ 55.51
MYS:JT8-15W40-2G	HEAVY DUTY MOTOR OIL..3 / 2 GAL	\$ 87.81
MYS:JT8-15W40-P	HEAVY DUTY MOTOR OIL..5 GAL	\$ 67.99
MYS:JT8-15W40-D	HEAVY DUTY MOTOR OIL..55 GAL	\$ 721.71
MYS:JT8-30WT-C	HEAVY DUTY MOTOR OIL..12 / 1QT	\$ 52.86
MYS:JT8-30WT-G	HEAVY DUTY MOTOR OIL..4 / 1GAL	\$ 58.86
MYS:JT8-30WT-2G	HEAVY DUTY MOTOR OIL..3 / 2 GAL	\$ 85.14
MYS:JT8-30WT-P	HEAVY DUTY MOTOR OIL..5 GAL	\$ 72.17
MYS:JT8-30WT-D	HEAVY DUTY MOTOR OIL..55 GAL	\$ 767.73
MYS:JT8-40WT-C	HEAVY DUTY MOTOR OIL..12 / 1QT	\$ 42.55
MYS:JT8-40WT-2G	HEAVY DUTY MOTOR OIL..3 / 2 GAL	\$ 85.14
MYS:JT8-40WT-P	HEAVY DUTY MOTOR OIL..5 GAL	\$ 72.17
MYS:JT8-50WT-P	HEAVY DUTY MOTOR OIL..5 GAL	\$ 86.74

Other Brands

MILE MASTER

OIL:M M -15W40-C	MOTOR OIL..12 / 1QTS	\$ 35.48
OIL:M M -15W40-4G	MOTOR OIL ..4 / 1GAL	\$ 46.76
OIL:M M -15W40-P	MOTOR OIL..5 GAL	\$ 52.65

PBO

PBO:15W40-P	HEAVY DUTY MOTOR OIL..55 GAL	\$ 33.75
PBO:15W40-D	HEAVY DUTY MOTOR OIL..55 GAL	\$ 560.49

SHELL

SHE:RIM -15W40-C	MOTOR OIL..12 / 1QT	\$ 56.03
SHE:RIM -15W40-D	MOTOR OIL..55 GAL	\$ 671.22

CHEVRON

CHE:400-30WT-C	DELO 400 MOTOR OIL..12 / 1QT	\$ 52.15
CHE:400-30WT-3G	DELO 400 MOTOR OIL..3 / 1GAL	\$ 48.47
CHE:400-40WT-C	DELO 400 MOTOR OIL..12 / 1QT	\$ 43.82
CHE:400-15W40-C	DELO 400 MOTOR OIL..12 / 1QT	\$ 59.00
CHE:400-15W40-3G	SELO 400 MOTOR OIL..3 / 1GAL	\$ 46.58

KENDALL

KEN:105-5302	SUPER D3 15W40 MOTOR OIL..12 / 1QT	\$ 45.86
KEN:15W40-XA-4G	SUPER D3 15W40 MOTOR OIL..4 / 1GAL	\$ 59.64

HAVOLINE

HAV:15W40-C	MOTOR OIL..12 / 1QT	\$ 41.10
-------------	---------------------	----------

SERVICE PRO

SPRO:15W40-C	HEAVY DUTY MOTOR OIL..12 / 1QTS	\$ 41.41
SPRO:15W40-D	HEAVY DUTY MOTOR OIL..55 GAL	\$ 673.72
SPRO:30HD-D	HEAVY DUTY MOTOR OIL..55 GAL	\$ 528.69



FOR 50+ YEARS,
PARKER
BROTHERS
HAS BEEN
SERVING ATLANTA.
THANK YOU FOR
YOUR CONTINUED
SUPPORT!!





LUBRICANTS

HEAVY DUTY MOTOR OIL

PENZOIL

PEN:15W40-P	MOTOR OIL..5 GAL	\$ 48.60
PEN:50WT-C	MOTOR OIL..12 / 1QT	\$ 26.32

VALVOLINE

VAL:ALFT-30WT-D	30 WT MOTOR OIL..55 GAL	\$ 514.33
VAL:15W40-G	15W40 MOTOR OIL..6 / 1 GAL	\$ 50.75

SYNTHETIC MOTOR OIL

Shell Formula Synthetic Motor Oils

Shell synthetic motor oil is designed to meet or exceed the current performance requirements. It's synthetic base gives it a longer service life than conventional motor oils.

SHE:SYN-5W20-C	SYNTHETIC MOTOR OIL..6 / 1QT	\$ 44.86
SHE:SYN-5W30-C	SYNTHETIC MOTOR OIL..6 / 1QT	\$ 45.50
SHE:SYN-5W30-D	SYNTHETIC MOTOR OIL..55 GAL	\$ 1228.37
SHE:SYN-10W30-C	SYNTHETIC MOTOR OIL..6 / 1QT	\$ 44.87

Shell Rotella T Synthetic Motor Oil

Shell Rotella T synthetic heavy duty motor oil is designed to meet or exceed the current performance requirements for virtually all four stroke engines (gasoline or diesel). It's synthetic base gives it a longer service life than conventional motor oils, and it will enhance gas mileage over the conventional 15W40.

SHE:R-T-S5W40-C	SYNTHETIC HEAVY DUTY MOTOR OIL..6 / 1QT	\$ 50.48
SHE:R-T-S5W40-3G	SYNTHETIC HEAVY DUTY MOTOR OIL..3 / 1 GAL	\$ 90.38
SHE:R-T-S5W40-D	SYNTHETIC HEAVY DUTY MOTOR OIL..55 GAL	\$ 1526.52

Other Brands

PURE GUARD

P/G:SYN-0W20-C	SYNTHETIC MOTOR OIL..12 / 1QT	\$ 27.14
P/G:SYN-5W20-C	SYNTHETIC MOTOR OIL..12 / 1QT	\$ 27.15
P/G:SYN-5W30-C	SYNTHETIC MOTOR OIL..12 / 1QT	\$ 4.15
P/G:SYN-10W30-C	SYNTHETIC MOTOR OIL..12 / 1QT	\$ 27.14

MYSTIK

MYS:JT8-0W20-C	SYNETHIC MOTOR OIL..12 / 1 QTS	\$ 36.69
MYS:JT8-S5W20-C	SYNETHIC MOTOR OIL..12 / 1 QTS	\$ 40.64
MYS:JT8-S10W30-C	SYNETHIC MOTOR OIL..12 / 1 QTS	\$ 42.43

SERVICE PRO

SPRO:SP-SYN-5W30-D	SYNTHETIC MOTOR OIL..55 GAL	\$ 729.00
--------------------	-----------------------------	-----------

Shell Formula SB motor oil

FormulaShell SB motor oil contains synthetic base stock to insure excellent low temperature flow to speed cold starts and provide extra engine protection during the extreme heat of summer. It also helps minimize wear. Keep engine components clean, help protect against high temperatures and oil thickening. It is the friction reducing properties that help increase gas mileage. API service classification SL.

SHE:5W30-SB-C	SEMI SYNTHETIC MOTOR OIL..12 / 1QT	\$ 61.59
---------------	------------------------------------	----------

Mystik® SX-8® Synthetic Blend Motor Oils

These synthetic blend 12 TBN super performers are designed to meet and exceed the current performance requirements of diesel engine manufacturers such as Caterpillar, Cummins, Detroit Diesel, Mack, and Navistar as well as all gasoline engine specifications. Mystik® SX-8® Synthetic Blend Motor Oils are a new dimension in engine lubrication. They are scientifically blended to get the best features of both synthetic and petroleum oils for increased performance. All oils meet API service classification SL,CF,CF-4,CG-4,CH-4

MYS:SYN-10W30-C	SEMI SYNTHETIC MOTOR OIL..12 / 1QT	\$ 43.94
MYS:SYN-10W30-D	SEMI SYNTHETIC MOTOR OIL..55 GAL	\$ 740.08

Other Brands

KENDALL

KEN:SYN-5W30-C	5W30 SYNTHETIC BLEND MOTOR OIL..12 / 1QT	\$ 42.26
KEN:SYN-10W30-C	10W30 SYNTHETIC BLEND MOTOR OIL..12 / 1QT	\$ 33.57

SERVICE PRO

SPRO:SB-5W30-D	SEMI SYNTHETIC MOTOR OIL..55 GAL	\$ 534.68
SPRO:SB-10W30-P	SEMI SYNTHETIC MOTOR OIL..5 GAL	\$ 49.05

MONDAY-FRIDAY
8am-5pm a helpful
HUMAN voice will
always answer the
phone
(770)474-1286



LUBRICANTS



HI PERFORMANCE MOTOR OIL

KENDALL GT-1(PETROLEUM BASE OIL)

KEN:527-7132	GT1 TURBO 10W40 MOTOR OIL..12 / 1 QT	\$ 53.33
KEN:527-7133	GT1 TURBO 30WT MOTOR OIL..12 / 1 QT	\$ 39.99
KEN:527-7134	GT1 TURBO 40WT MOTOR OIL..12 / 1 QT	\$ 36.60
KEN:527-7135	GT1 TURBO 50WT MOTOR OIL..12 / 1 QT	\$ 36.60
KEN:527-7137	GT1 TURBO NITRO 70WT MOTOR OIL..12 / 1 QT	\$ 59.97
KEN:527-7138	GT1 TURBO 20W50 MOTOR OIL..12 / 1 QT	\$ 47.95
KEN:527-7139	GT1 TURBO 15W40 MOTOR OIL..12 / 1 QT	\$ 43.52

VALVOLINE

VAL:211-C	20W50 RACING MOTOR OIL..12 / 1 QT	\$ 57.72
VAL:RACING20W50-C	20W50 RACING ONLY MOTOR OIL..6 / 1 QT	\$ 49.06

INDUSTRIAL MOTOR OIL

Mystik Non-Detergent Motor Oils

Non-Detergent Motor Oils are manufactured from high quality virgin oil with added foam inhibitors. They are for use in noncritical applications where the equipment manufacturer recommends the use of non-detergent oils. Non-detergent oils may be used in the following applications: GL-I gear oil; SA motor oil; general machine oil; and low pressure, noncritical hydraulic applications.

MYS:10ND-C	NON-DETERGENT INDUSTRIAL MOTOR OIL..12 / 1 QT	\$ 34.12
MYS:10ND-D	NON-DETERGENT INDUSTRIAL MOTOR OIL..55 GAL	\$ 531.52
MYS:10ND-P	NON-DETERGENT INDUSTRIAL MOTOR OIL..5 GAL	\$ 52.64
MYS:20ND-C	NON-DETERGENT INDUSTRIAL MOTOR OIL..12 / 1 QT	\$ 40.38
MYS:20ND-D	NON-DETERGENT INDUSTRIAL MOTOR OIL..55 GAL	\$ 429.50
MYS:30ND-C	NON-DETERGENT INDUSTRIAL MOTOR OIL..12 / 1 QT	\$ 34.48
MYS:30ND-D	NON-DETERGENT INDUSTRIAL MOTOR OIL..55 GAL	\$ 747.98
MYS:40ND-C	NON-DETERGENT INDUSTRIAL MOTOR OIL..12 / 1 QT	\$ 36.29
MYS:50ND-P	NON-DETERGENT INDUSTRIAL MOTOR OIL..5 GAL	\$ 51.33
MYS:50ND-D	NON-DETERGENT INDUSTRIAL MOTOR OIL..55 GAL	\$ 521.57



Shell MYSELLA® Oils

Shell MYSELLA Oils are ash free, dispersant crankcase oils for use in engines fueled by natural gas.. Shell MYSELLA Oils Single Grade Oils are recommended for all 2-and 4-stroke cycle gas fueled engines for which the manufacturer does not specify an ash type oil. Typical installations are in gas transmission, total energy plants, electric power generators, chemical plants and various engine applications.

SHE:MYSELLA-40-D	NATURAL GAS ENGINE OIL ..55 GAL	\$ 956.34
------------------	---------------------------------	-----------

Shell CAPRINUS® Oils

Shell CAPRINUS Oils are railroad and marine premium quality, high alkalinity crankcase oils, formulated to maximize component life in large medium-speed diesel engines. The exclusive additive technology used in these lubricants builds on many years of experience , field testing and extensive work with engine manufacturers. Meets the requirements for LMOA Generation 5 for extended drains.

SHE:CAPRINUS-XR40-D	RAILROAD & MARINE ENGINE OIL..55 GAL	\$ 1099.85
---------------------	--------------------------------------	------------



AUTOMOTIVE TRANSMISSION FLUID

Shell Automotive Transmission Fluids

Shell DONAX TG is approved by General Motors as meeting its DEXRON III specification, and by Ford as meeting its MERCON specification. It has the widest range of application for an automatic transmission fluid.

SHE:ATF-C	TRANSMISSION FLUID..12 / 1 QT	\$ 47.85
SHE:ATF-P	TRANSMISSION FLUID..5 GAL	\$ 66.26
SHE:SPIRAX-S3-ATF-MD3-D	TRANSMISSION FLUID..55 GAL	\$ 619.29

Other Brands

PURE GUARD

P/G:ATF-D	TRANSMISSION FLUID..55 GAL	\$ 520.00
-----------	----------------------------	-----------

SERVICE PRO

SPRO:ATF-P	TRANSMISSION FLUID..5 GAL	\$ 52.51
SPRO:ATF-D	TRANSMISSION FLUID..55 GAL	\$ 520.00

MILEMASTER

OIL:MM-ATF-C	AUTOMATIC TRANSMISSION FLUID..12 / 1 QTS	\$ 31.90
--------------	--	----------





LUBRICANTS

AUTOMOTIVE TRANSMISSION FLUID



Mystik Ford Transmission Fluid

Ford Transmission Fluid is recommendation for service fill in most Ford Motor Company passenger car and truck automatic transmissions manufactured prior to 1981.

MYS:FORD-P	TYPE F TRANSMISSION FLUID..5 GAL	\$ 260.10
MYS:FORD-D	TYPE F TRANSMISSION FLUID..55 GAL	\$ 811.80

ATF +4

ATF +4 is the recommended Chrysler transmission fluid for 2000 and newer models.

VAL:ATF4-C	TYPE 4 TRANSMISSION FLUID..12 / 1QT	\$ 69.75
------------	-------------------------------------	----------

Shell Multi-Vehicle Automatic Transmission Fluids

Shell Multi-Vehicle automatic Transmission Fluid is a specially formulated fluid designed to meet the requirements of a broad range of automatic transmission specifications. It is a special blend of high quality base stock with an advanced additive system for automatic and powershift transmissions. It protects against shudder, eliminates the need to stock ATF supplements, and ensures a high performance smooth driving experience. It replaces DEXRON, DEXRON II, DEXRON IIE, DEXRON III, Type A, MERCON, MERCON 5, ATF +3, ATF +4, Allison C-4, and Caterpillar TO-2. NOT a suitable replacement for a few pre-1986 vehicles were Type F fluids were specified, vehicles requiring DEXRON VI and some recent vehicle with continuous variable speed transmissions.

SHE:MULTIVEHICLE-ATF-C	MULTI VEHICLE SYNTHETIC AUTOMATIC TRANSMISSION FLUID..12 / 1 QT	\$ 42.32
SHE:MULTIVEHICLE-ATF-D	MULTI VEHICLE SYNTHETIC AUTOMATIC TRANSMISSION FLUID..55 GAL	\$ 918.48

Other Brands

PURE GUARD

P/G:M V ATF-C	MULTI VEHICLE AUTOMATIC TRANSMISSION FLUID..12 / 1 QT	\$ 57.05
P/G:M V ATF-D	MULTI VEHICLE AUTOMATIC TRANSMISSION FLUID..55 GAL	\$ 1,004.28

Allison Transynd Transmission Fluid

SHE:DONAX-TX-D	ALLISON TRANSMISSION FLUID..55 GAL	\$ 1,586.59
SHE:DONAX-TX-P	ALLISON TRANSMISSION FLUID..5 GAL	\$ 197.92
CIT:QUATRASYN-P	SYNTHETIC ALLISON TRANSMISSION FLUID..5 GAL	\$ 217.27
CIT:QUATRASYN-D	SYNTHETIC ALLISON TRANSMISSION FLUID..55 GAL	\$ 1,957.30

AUTOMOTIVE GEAR OIL

Shell SPIRAX® Heavy Duty Gear Oil

Shell SPIRAX HD Gear Oils are extreme-pressure, multigrade, multipurpose gear lubricants for automotive differentials and manual transmissions.

SHE:SPI-80W90-P	GEAR OIL..35 LB	\$ 92.90
SHE:SPI-80W90-K	GEAR OIL..120 LB	\$ 289.57
SHE:SPI-80W90-D	GEAR OIL..400 LB	\$ 946.79
SHE:SPI-85W140-C	GEAR OIL..12 / 1 QT	\$ 64.86
SHE:SPI-85W140-P	GEAR OIL..35 LB	\$ 90.84
SHE:SPI-85W140-K	GEAR OIL..120 LB	\$ 289.57
SHE:SPI-85W140-D	GEAR OIL..400 LB	\$ 893.89

Mystik® JT-7® Multi-Purpose Gear Lubricants

For Limited Slip Axle Lubrication Mystik® JT-7® Multi-Purpose Gear Lubricants are multi-purpose, thermally stable, sulfur-phosphorus extreme pressure (EP) gear lubricants that meet or exceed the performance requirements of API GL-2 through GL-6 and new designation MT-1 for non-synchronized manual transmissions, MIL-L-2105D, and Mack GO-H A specially balanced additive provides thermally stable gear lubricants with exceptional durability under high temperature conditions. Not all thermally stable gear lubricants are thermally durable, many lose their EP performance when subjected to thermal stress. Mystik® JT-7® Multi-Purpose Gear Lubricants can take the heat and continue to provide superior EP protection, minimum gear wear, excellent deposit control and improved rust and corrosion protection under extreme service conditions. Recommended for all automotive and heavy duty axles.

MYS:JT7-80W90-C	LIMITED SLIP GEAR OIL..12 / 1QT	\$ 55.59
MYS:JT7-80W90-P	LIMITED SLIP GEAR OIL..35 LB	\$ 82.48
MYS:JT7-80W90-K	LIMITED SLIP GEAR OIL..120 LB	\$ 281.01
MYS:JT7-80W90-D	LIMITED SLIP GEAR OIL..400 LB	\$ 901.90
MYS:JT7-85W140-C	LIMITED SLIP GEAR OIL..12 / 1QT	\$ 55.59
MYS:JT7-85W140-P	LIMITED SLIP GEAR OIL..35 LB	\$ 82.48
MYS:JT7-85W140-K	LIMITED SLIP GEAR OIL..120 LB	\$ 281.01
MYS:JT7-85W140-D	LIMITED SLIP GEAR OIL..400 LB	\$ 901.90



LUBRICANTS



AUTOMOTIVE GEAR OIL

Other Brands

PUREGUARD

P/G:80W90-C	GEAR OIL..12 / 1 QT	\$ 65.80
P/G:GL5-80W90-P	GEAR OIL..35 LB	\$ 55.50
P/G:GL5-80W90-K	GEAR OIL..120 LB	\$ 207.00
P/G:85W140-C	GEAR OIL..12 / 1 QT	\$ 42.18
P/G:GL5-85W140-P	GEAR OIL..35 LB	\$ 59.19
P/G:GL5-85W140-K	GEAR OIL..120 LB	\$ 252.30
P/G:GL5-85W140-D	GEAR OIL..400 LB	\$ 713.40
P/G:GL1-90WT-P	GEAR OIL..35 LB	\$ 59.73

SERVICE PRO

SPRO:GL580W90-P	GEAR OIL..35 LB	\$ 62.93
SPRO:80W90-P	GEAR OIL..35 LB	\$ 62.23
SPRO:80W90-K	GEAR OIL..120 LB	\$ 281.93

Shell SPIRAX® EW Gear Oils

Shell SPIRAX EW Gear Oils are high performance, multigrade extreme-pressure lubricants that are approved for extended warranty. They are formulated to meet today's challenges of heavier trucks, higher speeds, higher temperatures, and extended drain intervals.

SHE:SPI-EW7590-P	SPIRAX EXTENDED WEAR GEAR OIL..35 LB	\$ 480.24
SHE:SPI-EW80W140-P	SPIRAX EXTENDED WEAR GEAR OIL..35 LB	\$ 148.35
SHE:SPI-EW80W140-K	SPIRAX EXTENDED WEAR GEAR OIL..120 LB	\$ 480.24

Shell SPIRAX® ASX R Gear Oils

Shell SPIRAX ASX R Gear Oils are full synthetic, fuel efficient, long life transmission and axle fluids, designed to provide ultimate protection to the latest heavy duty manual transmissions and axles. They provide lower operating temperatures and longer equipment life.

SHE:SPI-ASXR75W90-C	SYNTHETIC GEAR OIL..12 / 1 QT	\$ 133.15
SHE:SPIRAX-S6-AXRME75W90-P	SYNTHETIC GEAR OIL..35 LB	\$ 202.63
SHE:SPI-AXRME-75W90-K	SYNTHETIC GEAR OIL..120 LB	\$ 644.59
SHE:SPI-ASXR75W90-D	SYNTHETIC GEAR OIL..400 LB	\$ 1,943.20
SHE:SPI-S6-AXRME-80W140-P	SYNTHETIC GEAR OIL..120 LB	\$ 227.18
SHE:SPI-ASXR80W140-K	SYNTHETIC GEAR OIL..120 LB	\$ 602.04

Shell SPIRAX GSX® Gear Oil (Formerly DENTAX® S)

Shell DENTAX S Gear Oil is a specially formulated, SAE 50, synthetic lubricant that was developed for heavy duty manual transmissions operating under severe conditions or requiring extended oil drain intervals.

SHE:SPIRAX-S6-GME50-P	SYNTHETIC GEAR OIL..35 LB	\$ 193.65
SHE:SPIRAX-GSX50-K	SYNTHETIC GEAR OIL..120 LB	\$ 565.31
SHE:SPIRAX-GSX50-D	SYNTHETIC GEAR OIL..400 LB	\$ 1,875.93

Mystik® SynGuard™ SX-7000™ Fluids

Mystik® SynGuard™ SX-7000™ Fluids are heavy-duty, state-of-the-art premium synthetic lubricants accepted by the Eaton/Fuller Corporation and Rockwell for use in conjunction with their extended warranty programs. These lubricants will also provide exceptional service in Spicer/Dana transmissions and differentials. They meet API Service MT-1 performance requirements for use in non-synchronized manual transmissions used in buses and heavy-duty trucks.

MYS:SYN-50-1G	SYNTHETIC GEAR OIL..1 GAL	\$ 10.26
MYS:SYN-S50-P	SYNTHETIC GEAR OIL..35 LB	\$ 178.29
MYS:SYN-75W90-1G	SYNTHETIC GEAR OIL..1 GAL	\$ 9.89
MYS:SYN-S75W90-P	SYNTHETIC GEAR OIL..35 LB	\$ 194.00
MYS:SYN-S80W140-P	SYNTHETIC GEAR OIL..35 LB	\$ 197.13
MYS:SYN-S80W140-K	SYNTHETIC GEAR OIL..35 LB	\$ 605.60

Other Brands

PUREGUARD

P/G:SYN-50WT-P	SYNTHETIC GEAR OIL..5 GAL	\$ 27.13
P/G:SYN-75W90-P	SYNTHETIC GEAR OIL..35 LB	\$ 14.35

Mystik® SynGuard™ SX-7™ Synthetic Blend Gear Lubricants

These synthetic blend gear lubricants are designed to operate over wide temperature ranges with highly improved efficiency and thermal stability. They are blended from premium quality petroleum and synthetic base stocks combined with the finest additive package on the market today. They are compatible with petroleum oils and conventional seal materials.

MYS:SYN-75W90-P	SEMI SYNTHETIC GEAR OIL..35 LB	\$ 198.10
MYS:SYN-75W90-K	SEMI SYNTHETIC GEAR OIL..120 LB	\$ 605.72



FOR 50+ YEARS,
PARKER
BROTHERS
HAS BEEN
SERVING ATLANTA.
THANK YOU FOR
YOUR CONTINUED
SUPPORT!!



LUBRICANTS

GREASE



Shell ALVANIA® EP Greases

Shell ALVANIA EP Greases contain a combination of extreme pressure and other additives to give increased load carrying properties. They have excellent salt water protection and anti-rust properties. They are recommended for both on and off-highway equipment, construction equipment and industrial applications that require extreme pressure protection in heavy or shock loading conditions

SHE:GADUS-S2V220-00-K	GREASE..120 LB	\$ 416.25
SHE:ALVANIA-EP0-P	GREASE..35 LB	\$ 158.30
SHE:ALVANIA-EP1-P	GREASE..120 LB	\$ 145.80
SHE:GADUS-S2V220-1T	GREASE..14 OZ TUBES	\$ 3.89
SHE:ALVANIA-EP2-P	GREASE..35 LB	\$ 67.50
SHE:ALVANIA-EP2-K	GREASE..120 LB	\$ 415.50
SHE:ALVANIA-EP2-D	GREASE..400 LB	\$ 132.20
SHE:ALVANIA-RL2-P	GREASE..35 LB	\$ 127.95



Shell RETINAX® CMX Grease

Shell RETINAX CMX Grease is a multipurpose lithium complex high dropping point extreme pressure grease containing molybdenum disulfide (moly). It is primarily intended for construction, mining, and agricultural equipment.

SHE:RETINAX-CM X2-T	GREASE..30 / 14 OZ TUBES	\$ 128.25
---------------------	--------------------------	-----------

Shell RETINAX® LX Grease

Shell RETINAX LX Grease is formulated for the severe requirements of heavy-duty truck service. It is made with a lithium complex thickener for high temperature performance, and contains selected additives to enhance its extreme pressure performance, oxidation stability and excellent water resistance. RETINAX LX, dyed red for easy identification, is suitable for lubrication of wheel bearings, chassis, king pins, universal joints and fifth wheels. It provides excellent oxidation stability for long life

SHE:RETINAX-LX2-T	GREASE..30 / 14 OZ TUBES	\$ 101.25
SHE:GADUS-S3V220C2-P	GREASE..35 LB	\$ 145.80
SHE:RETINAX-LX2-K	GREASE..120 LB	\$ 415.80
SHE:RETINAX-LX2-D	GREASE..400 LB	\$ 1338.00



Shell RETINAX® Grease AM

Shell RETINAX Grease Am is a multipurpose lithium soap grease that contains molybdenum disulfide. It has a good dropping point, good mechanical stability, rust inhibition and water resistance. Applications : heavy loads, off-highway, over the road and industrial equipment. Features and benefits : 3% molybdenum disulfide for enhanced EP performance, corrosion protection in salt water, rust inhibition, water resistance, temperature range extends to 275F, and no lead.

SHE:RETINAX-EPX2-P	GREASE..35 LB	\$ 140.79
--------------------	---------------	-----------

Mystik® JT-6® Multi-Purpose Grease

Mystik® JT-6® is our most highly water wash resistant and water insoluble product. It is light colored and low staining and has a very low oil separation rate. It protects under high loads -- "antiseize." Excellent adhesion permits it to have better "stay-ability" than most other greases. A medium temperature range, multi-purpose grease for extreme pressure loads, medium slow to medium high speed bearings, it is excellent for greased chassis points, fifth wheels, and water pumps.

MYS:JT6-1T	MULTI PURPOSE GREASE..14 OZ TUBE	\$ 2.70
MYS:JT6-1LB	MULTI PURPOSE GREASE..1 LB	\$ 2.96
MYS:JT6-7LB	MULTI PURPOSE GREASE..7 LB	\$ 20.28
MYS:JT6-3OZ-3	MULTI PURPOSE GREASE..3 / 3 OZ TUBES	\$ 17.78
MYS:JT6-SPRAY-E	MULTI PURPOSE GREASE..15 OZ AEROSOL	\$ 4.26
MYS:JT6-P	MULTI PURPOSE GREASE..35 LB	\$ 95.58
MYS:JT6-K	MULTI PURPOSE GREASE..120 LB	\$ 321.30
MYS:JT6-D	MULTI PURPOSE GREASE..400 LB	\$ 1062.00

MONDAY-FRIDAY
8am-5pm a helpful
HUMAN voice will
always answer the
phone
(770)474-1286



Other Brands

CHEVRON

CHE:ULTRA-EP2-P	ULTRA DUTY EP 2 GREASE..35 LB	\$ 118.96
CHE:ULTRA-EP2-K	ULTRA DUTY EP 2 GREASE..120 LB	\$ 365.40



LUBRICANTS



GREASE

Mystik® JT-6® Hi-Temp Multi-Purpose Greases

These high temperature greases have excellent multi-purpose properties combined with a dropping point of 550°F. to give them application over a wide temperature range. Mystik® JT-6® Hi-Temp greases exhibit a Timken OK Load in excess of 80 pounds and excellent Four-Ball Wear and EP performance. They will provide superior protection to lubricate a wide variety of automotive, agricultural, trucking, mining, construction, and industrial equipment with excellent performance in severe applications and unequaled shock load protection.

MYS:JT6-HI-T-1T	HIGH TEMPERATURE GREASE..14 OZ TUBE	\$ 3.03
MYS:JT6-HI-T-1LB	HIGH TEMPERATURE GREASE..1 LB	\$ 3.37
MYS:JT6-HI-T-7LB	HIGH TEMPERATURE GREASE..7 LB	\$ 22.59
MYS:JT6-HI-T-P	HIGH TEMPERATURE GREASE..35 LB	\$ 3.01
MYS:JT6-HI-T-K	HIGH TEMPERATURE GREASE..120 LB	\$ 372.60
MYS:JT6-HI-T-D	HIGH TEMPERATURE GREASE..400 LB	\$ 1,206.18



Other Brands

SERVICEPRO

SPRO:HI-T-K	HIGH TEMPERATURE GREASE..120 LB	\$ 289.32
-------------	---------------------------------	-----------

Shell Albida LC Grease

Shell Albida LC greases are multipurpose, lithium complex, extreme pressure greases. They have high dropping points of more than 500 degrees F, excellent mechanical stability, and high film strength. These grease are designed for the lubrication of heavy duty automotive and industrial equipment where heavy load and wet condition are present

SHE:ALBIDA-EP 1-T	GREASE..30 / 14 OZ TUBES	\$ 126.00
SHE:ALBIDA-EP 1-K	GREASE..120 LB	\$ 443.20



Mystik General Purpose Grease

General Purpose Grease is a very economical multi-purpose grease especially suited for normal temperature/speed conditions and other non-critical service applications, as well as those applications requiring frequent re-greasing because of a contaminating environment.

MYS:GP GREASE-1T	GREASE..14 OZ TUBE	\$ 53.97
MYS:GP GREASE-P	GREASE..35 LB	\$ 636.08
MYS:GP GREASE-K	GREASE..120 LB	\$ 582.45
MYS:GP GREASE-D	GREASE..400 LB	\$ 57.83

Other Brands

KENDALL

KEN:252-7867	L427 SUPER BLUE GREASE..1 LB	\$ 3.82
KEN:567-7867	L-427 BLUE GREASE..14 OZ CARTRIDGE	\$ 3.24
KEN:661-7867	L-427 BLUE GREASE..35 LB PAIL	\$ 110.12



Other Brands

SERICPRO

SPRO:EP 2-D	LITHIUM GREASE..400 LB	\$ 625.00
-------------	------------------------	-----------

Mystik® Disc Brake Wheel Bearing Grease

Mystik® Disc Brake Wheel Bearing Grease is a premium quality lithium complex EP grease specifically formulated for disc brake wheel bearings and similar high temperature bearing applications, also an excellent choice for multi-purpose automotive applications (disc brake wheel bearings, universal joints and general chassis).

MYS:DISC-1LB	DISC BRAKE WHEEL BEARING GREASE..1 LB	\$ 2.75
MYS:DISC-7LB	DISC BRAKE WHEEL BEARING GREASE..7 LB	\$ 15.80
MYS:DISC-P	DISC BRAKE WHEEL BEARING GREASE..35 LB	\$ 59.40



Other Brands

PENZOIL

PEN:707L-K	PREMIER WHEEL BEARING GREASE..120 LB	\$ 313.20
------------	--------------------------------------	-----------

Shell DARINA® SD Greases

Shell DARINA EP Greases are premium quality, multipurpose, extreme pressure, non-soap greases that can be used in industrial plant applications over a wider temperature range than most industrial soap based greases. They are made with non-melting MICROGEL® inorganic thickener.

SHE:DARINA-SD2-P	GREASE..35 LB	\$ 153.89
SHE:DARINA-SD2-K	GREASE..120 LB	\$ 459.00





LUBRICANTS

GREASE

Mystik

The Ultimate
In Fine
Lubrication



Mystik® SX.6™ Synthetic Blend Extreme Range Multi-Purpose Greases

Mystik® SX-6™ greases are premium quality, multi-purpose, high temperature, lithium complex EP greases with excellent low temperature properties. A unique blend of petroleum base oils and synthetic fluids gives them excellent resistance to oxidation at elevated temperatures and exceptionally low start-up resistance (torque) under extreme low temperature conditions.

MYS:JT6-SYN-1T	SEMI SYNTHETIC GREASE..14 OZ TUBE	\$ 3.28
MYS:SYN-JT6-P	SYNTHETIC BLEND GREASE..35 LB	\$ 167.70

Other Brands

PERMATEX

PER:81943	ULTRA SLICK SYNTHETIC LUBRICANT WITH PTFE..12 OZ AEROSOL	\$ 6.23
PER:81944	ULTRA SLICK SYNTHETIC LUBRICANT WITH PTFE..14 OZ CARTRIDGE	\$ 8.53
PER:81945	ULTRA SLICK SYNTHETIC LUBRICANT WITH PTFE..1LB TUB	\$ 10.35
PER:81946	ULTRA SLICK SYNTHETIC LUBRICANT WITH PTFE..3 OZ TUBE	\$ 4.98

Mystik JT6 3% Moly EP No. 2 Grease

JT6 3% Moly-Lithium EP No. 2 Grease is a fully additive-treated, multi-purpose grease that is water insoluble and treated for extra protection under very severe service conditions. Use in general-purpose applications where medium to very severe conditions prevail.

MYS:JT6-HI-M OLY-1T	HIGH TEMPERATURE 3% MOLY-LITHIUM GREASE..14 OZ TUBE	\$ 3.36
MYS:JT6-HI-M OLY-P	HIGH TEMPERATURE 3% MOLY-LITHIUM GREASE..35 LB	\$ 117.23
MYS:JT6-HI-M OLY-K	HIGH TEMPERATURE 3% MOLY-LITHIUM GREASE..120 LB	\$ 406.20
MYS:JT6-HI-M OLY-D	HIGH TEMPERATURE 3% MOLY-LITHIUM GREASE..400 LB	\$ 1,330.00

Mystik® OG-5 Outside Gear Grease

Mystik® OG-5 Outside Gear Grease is water insoluble and has excellent resistance to washing, is very sticky and adhesive, is stringy and self-spreading, and is superior in leaving a corrosion resistant film. It also has a high level of soluble antiwear and extreme pressure chemical additives. It may also be used as a wide temperature open gear grease, or for sliding applications such as guide rails, fifth wheels, slideways, etc.

MYS:OG-5-C	OUTSIDE GEAR GREASE ..25 / 10 OZ TUBE	\$ 48.61
MYS:OG-5-P	OUTSIDE GEAR GREASE..35 LB	\$ 88.77
MYS:OG-5-K	OUTSIDE GEAR GREASE..120 LB	\$ 329.37

Mystik® JT6 LT Low Temperature Grease

Mystik® Jt6 LT-200 Low Temperature Multi-Purpose Grease is light colored, low staining and water insoluble, and its antiwear additive protects under high loads. It is a low to medium temperature range, multi-purpose grease for bearings and grease lubricated chassis applications. It is also for extremely cold temperatures where minimum friction is necessary and where high speeds are involved.

MYS:JT6-LT-1T	LOW TEMPERATURE GREASE..14 OZ TUBE	\$ 2.79
MYS:JT6-LT-P	LOW TEMPERATURE GREASE..35 LB	\$ 104.20
MYS:JT6-LT-K	LOW TEMPERATURE GREASE..120 LB	\$ 332.41
MYS:JT6-LT-D	LOW TEMPERATURE GREASE..400 LB	\$ 1,062.00

Shell RETINAX® TL 00 Grease

Shell RETINAX TL 00 Grease is a premium quality grease formulated with a selected synthetic base oil and a lithium complex thickener system to produce a semi-fluid grease for trailer axle hubs. It is used in place of heavy duty gear oils because it reduces leakage.

SHE:RETINAX-TL00-P	GREASE..35 LB	\$ 292.44
--------------------	---------------	-----------

Mystik Centra-Lube Grease

Designed as an industrial semi-fluid grease for central systems where harder consistency greases are not pumpable in cold weather. This premium quality product contains extreme pressure, antiwear, antirust, and antioxidant additives. This product contains no lead or heavy metal additives and is insoluble in water.

MYS:CL-00-P	GREASE..35 LB	\$ 88.74
MYS:CL-00-K	GREASE..120 LB	\$ 336.00

Mystik

LUBRICANTS

Parker Brothers
gladly accepts
Visa, Mastercard
Discover &
American Express



Mystik

LUBRICANTS

LUBRICANTS



GREASE

Shell CYPRINA~ RA Grease

Shell CYPRINA RA Grease is an NLGI Grade 3 lithium soap grease that is specifically designed for use in diesel electric locomotive traction motor bearing lubrication. This grease provides excellent mechanical stability and long service life.

SHE:CYPRINA-RA-P	GREASE..35 LB	\$ 164.16
SHE:CYPRINA-RA-D	GREASE..400 LB	\$ 1,241.73

Other Greases

White Lithium Grease

PENZOIL

PEN:PEN705-T	WHITE LITHIUM GREASE..14 OZ TUBE	\$ 2.99
PEN:PEN705-P	WHITE LITHIUM GREASE ..35 LB	\$ 111.39
PEN:PEN705-K	WHITE LITHIUM GREASE ..120 LB	\$ 383.40

5th Wheel Grease

PERMATEX

PER:01010	SLIK-PAK 5TH WHEEL GREASE..2 OZ PACK	\$ 0.84
-----------	--------------------------------------	---------

Non Melting Grease

LPS

LPS:05816	RED AND REDINON MELTING GREASE..11 OZ AEROSOL	\$ 10.78
-----------	---	----------



TRANS-HYDRAULIC FLUID

Shell SPIRAX-S4TXM Transmission Fluids

Shell SPIRAX-S4TXM Transmission Fluids are premium oils for automotive transmissions and hydraulic systems.

SHE:SPIRAX-S4TXM -D	TRANS-HYDRAULIC OIL..55 GAL	\$ 795.51
---------------------	-----------------------------	-----------

Shell Donax TC

Shell Donax TC oils are designed to meet the demanding requirements of modern transmissions, final drive, oil immersed brake and hydraulic systems fitted for heavy duty off road equipment. They meet the Caterpillar TO-4 specification as well as the Allison C-4 requirements for transmission and drive train fluids and are available in SAE viscosity grades 10W, 30, 50 and 60.

SHE:DONAX-TC 10-P	TRANS-HYDRAULIC OIL..55 GAL	\$ 79.13
SHE:DONAX-TC 10WT-D	TRANS-HYDRAULIC OIL..5 GAL	\$ 956.17
SHE:DONAX-TC 30-P	TRANS-HYDRAULIC OIL..5 GAL	\$ 90.08

Mystik® Tenax™ Fluids

Mystik® Power Lubricants™ Tenax™ Fluids are heavy duty transmission and final drive lubricants formulated to meet the performance requirements of Caterpillar TO-4 (10W, 30, & 50) and Allison C-4 (10W & 30). They provide the protective qualities essential to maximize equipment life and performance.

MYS:TENAX-10-P	TRANS-HYDRAULIC OIL..5 GAL	\$ 80.91
MYS:TENAX-10-D	TRANS-HYDRAULIC OIL..55 GAL	\$ 813.45
MYS:TENAX-30-P	TRANS-HYDRAULIC OIL..5 GAL	\$ 79.40
MYS:TENAX-30-D	TRANS-HYDRAULIC OIL..55 GAL	\$ 842.21
MYS:TENAX-50-P	TRANS-HYDRAULIC OIL..5 GAL	\$ 77.44
MYS:TENAX-50-D	TRANS-HYDRAULIC OIL..55 GAL	\$ 842.17

Parker Brothers Universal Trans-Hydraulic Fluid

Universal Trans-Hydraulic Fluid incorporates the most advanced additive technology available today with the finest paraffinic base stocks to provide unsurpassed performance in modern agricultural equipment. It provides excellent extreme pressure protection for maximum gear life and capacity for wet brakes and PTO clutches. Excellent wet brake noise suppression and filterability characteristics along with rust and corrosion inhibitors, water tolerance, and wide temperature range performance.

PBO:TRANS-UNIV-P	TRANS-HYDRAULIC OIL..5 GAL	\$ 58.06
PBO:TRANS-UNIV-D	TRANS-HYDRAULIC OIL..55 GAL	\$ 479.26

Other Brands

MYSTIK

MYS:TRANS-HYD-P	TRANS-HYDRAULIC OIL..5 GAL	\$ 74.97
MYS:JT5-TRANSHYD-D	TRANS-HYDRAULIC OIL..55 GAL	\$ 777.44

PURE GUARD

P/G:PREMIUM-TRACTOR-P	TRANS-HYDRAULIC OIL..5 GAL	\$ 54.71
P/G:PREMIUM-TRACTOR-D	TRANS-HYDRAULIC OIL..55 GAL	\$ 527.43

FOR 50+ YEARS,
PARKER
BROTHERS
HAS BEEN
SERVING ATLANTA.
THANK YOU FOR
YOUR CONTINUED
SUPPORT!!



P B O
Parker Brothers Oil
Packaged by Mystik



LUBRICANTS

HYDRAULIC FLUID

Mystik® Anti-Leak Industrial Oil

Mystik® Anti-Leak Industrial Oil is a very wide temperature range, multiple viscosity grade oil specially treated for maximum leakage resistance. Fortified with antiwear, antifoam, antirust, and antioxidant stabilizer additives for long life. It has a special "antisplatter" additive for splash resistance and a slower "drip off" rate.

MYS:ANTI-LEAK-D	15W40 INDUSTRIAL OIL..55 GAL	\$ 778.36
MYS:ANTI-LEAK-P	15W40 INDUSTRIAL OIL..5 GAL	\$ 55.10

Mystik® AW/AL Hydraulic Oils

These are premium quality antiwear, antileak, and antifoam hydraulic oils formulated for use in modern high and low pressure industrial and mobile hydraulic systems. They meet the toughest requirements of most manufacturers and are dyed green for ease of identification from other petroleum products. They have 100% paraffinic high VI base oils with low pour points, for wide temperature usage and additionally are treated with antioxidant stabilizers for long life and antirust protective additive. A fully synthetic seal swell agent prevents and stops minor leaks and provides longer seal life.

MYS:AW/AL-32-P	HYDRAULIC OIL..5 GAL	\$ 72.65
MYS:AW/AL-32-D	HYDRAULIC OIL..55 GAL	\$ 751.25
MYS:AW/AL-68-2G	HYDRAULIC OIL..3 / 2 GAL	\$ 87.18
MYS:AW/AL-68-P	HYDRAULIC OIL..5 GAL	\$ 72.65
MYS:AW/AL-68-D	HYDRAULIC OIL..55 GAL	\$ 751.21
MYS:AW/AL-100-P	HYDRAULIC OIL..5 GAL	\$ 72.65
MYS:AW/AL-100-D	HYDRAULIC OIL..55 GAL	\$ 751.21

Shell TELLUS® Oils

Shell TELLUS Oils are antiwear hydraulic oils designed to give long service in high output hydraulic systems that use vane, piston or gear pumps. These oils help stretch oil and pump life in extended heavy duty service with their balance of excellent properties. Shell TELLUS Oils are blended with specially selected paraffinic HVI base oils and incorporate a proprietary additive that is a leader in keeping systems clean.

SHE:TELLUS-S2M 32-P	HYDRAULIC OIL..5 GAL	\$ 77.69
SHE:TELLUS-S2M 32-D	HYDRAULIC OIL..55 GAL	\$ 722.61
SHE:TELLUS-46-P	HYDRAULIC OIL..5 GAL	\$ 69.01
SHE:TELLUS-S2M 46-D	HYDRAULIC OIL..55 GAL	\$ 648.94
SHE:TELLUS-68-P	HYDRAULIC OIL..5 GAL	\$ 75.11
SHE:TELLUS-S2M 68-D	HYDRAULIC OIL..55 GAL	\$ 625.39
SHE:TELLUS-S2M -100-P	HYDRAULIC OIL..5 GAL	\$ 76.77
SHE:TELLUS-150-P	HYDRAULIC OIL..5 GAL	\$ 68.07

Shell TELLUS® Premium Hydraulic Oils

Shell Tellus Premium Hydraulic Oils are hydrotreated base oils blended with unique Shell additive technology to provide : resistance to degradation and sludge formation, component wear protection, stability and component protection in the presence of moisture, and high performance under ultra fine filtration. These oils are designed to prolong component life, prolong oil life, and promote better system cleanliness

SHE:TELLUS-P 32-D	PREMIUM HYDRAULIC OIL..55 GAL	\$ 700.79
SHE:TELLUS-P 46-D	PREMIUM HYDRAULIC OIL..55 GAL	\$ 700.79
SHE:TELLUS-P 68-P	PREMIUM HYDRAULIC OIL..5 GAL	\$ 78.42
SHE:TELLUS-P 68-D	PREMIUM HYDRAULIC OIL..55 GAL	\$ 700.79

Shell TELLUS® T Oils

Shell TELLUS T Oils are premium grade, very high viscosity index hydraulic oils designed for use in mobile and industrial equipment that is operated in a wide range of subarctic and temperate climates. TELLUS T Oils offer outstanding low temperature properties.

SHE:TELLUS-T 15-P	LOW TEMPERATURE HYDRAULIC OIL..5 GAL	\$ 97.36
SHE:TELLUS-T 15-D	LOW TEMPERATURE HYDRAULIC OIL..55 GAL	\$ 991.39
SHE:TELLUS-S2V22-P	LOW TEMPERATURE HYDRAULIC OIL..5 GAL	\$ 82.68
SHE:TELLUS-S2V22-D	LOW TEMPERATURE HYDRAULIC OIL..55 GAL	\$ 943.41
SHE:TELLUS-T32-P	LOW TEMPERATURE HYDRAULIC OIL..5 GAL	\$ 88.80
SHE:TELLUS-T32-D	LOW TEMPERATURE HYDRAULIC OIL..55 GAL	\$ 798.30
SHE:TELLUS-T46-P	LOW TEMPERATURE HYDRAULIC OIL..5 GAL	\$ 75.46
SHE:TELLUS-S2V46-D	LOW TEMPERATURE HYDRAULIC OIL..55 GAL	\$ 938.65
SHE:TELLUS-T46-TOTE	LOW TEMPERATURE HYDRAULIC OIL..275 GAL	\$ 3,243.50
SHE:TELLUS-T68-D	LOW TEMPERATURE HYDRAULIC OIL..55 GAL	\$ 804.77
SHE:TELLUS-T 100-D	LOW TEMPERATURE HYDRAULIC OIL..55 GAL	\$ 857.79

Other Brands

CITGO

CIT:ALLTEMP-D	LOW TEMPERATURE HYDRAULIC OIL..55 GAL	\$ 622.16
---------------	---------------------------------------	-----------



MONDAY-FRIDAY
8am-5pm a helpful
HUMAN voice will
always answer the
phone
(770)474-1286



LUBRICANTS



HYDRAULIC FLUID

Parker Brothers AW Hydraulic Oil

This oil offers excellent antiwear protection with rust, oxidation and foam inhibitors plus the economy of good quality, fully refined 100% naphthenic base stock with good oxidation stability and a special additive to provide high viscosity index properties.

PBO:AW32-P	HYDRAULIC OIL..5 GAL	\$ 47.83
PBO:AW32-D	HYDRAULIC OIL..55 GAL	\$ 444.22
PBO:AW46-P	HYDRAULIC OIL..5 GAL	\$ 49.22
PBO:AW46-D	HYDRAULIC OIL..55 GAL	\$ 442.59
PBO:AW68-P	HYDRAULIC OIL..5 GAL	\$ 49.97
PBO:AW68-D	HYDRAULIC OIL..55 GAL	\$ 427.89

P B O
Parker Brothers Oil
Packaged by Mystik

Other Brands

MYSTIK

MYS:POWER-LUBE	HYDRAULIC OIL..5 GAL	\$ 28.75
MYS:ECONO-HYD-D	HYDRAULIC OIL..55 GAL	\$ 372.98

PUREGUARD

P/G:PG-AW32-P	HYDRAULIC OIL..5 GAL	\$ 40.59
P/G:AW32-GE	HYDRAULIC OIL..1 GAL	\$ 10.43
P/G:PG-AW32-D	HYDRAULIC OIL..55 GAL	\$ 447.86
P/G:PG-AW46-P	HYDRAULIC OIL..5 GAL	\$ 40.59
P/G:PG-AW46-D	HYDRAULIC OIL..55 GAL	\$ 447.86
P/G:PG-AW68-P	HYDRAULIC OIL..5 GAL	\$ 40.59
P/G:PG-AW68-D	HYDRAULIC OIL..55 GAL	\$ 447.86



SERVICEPRO

SPRO:AW32-P	HYDRAULIC OIL..5 GAL	\$ 48.03
SPRO:AW32-D	HYDRAULIC OIL..55 GAL	\$ 522.45
SPRO:AW46-P	HYDRAULIC OIL..5 GAL	\$ 50.64
SPRO:AW68-P	HYDRAULIC OIL..5 GAL	\$ 51.54
SPRO:SP-AW68-D	HYDRAULIC OIL..55 GAL	\$ 542.06

Speciality Hydraulic Oils

Water Safe / Fire Resistant Hydraulic Oil

CITGO

CIT:AQUA-32-D	WATER SAFE FIRE RESISTANT HYDRAULIC OIL..55 GAL	\$ 863.28
CIT:AQUA-46-D	WATER SAFE FIRE RESISTANT HYDRAULIC OIL..55 GAL	\$ 863.28

Parker Brothers
gladly accepts
Visa, Mastercard
Discover &
American Express

INDUSTRIAL GEAR OIL

Shell OMALA® Gear Oils

Shell OMALA Gear Oils protect and help extend the service life of a wide variety of enclosed industrial gearing, including spur, bevel, herringbone and some worm gears. These premium quality oils are formulated with high viscosity index oils and a sulfur/phosphorus extreme pressure additive package which contains no lead.

SHE:OMALA-S2G68-P	INDUSTRIAL GEAR OIL..35 LB	\$ 103.95
SHE:OMALA-S2-G68-D	INDUSTRIAL GEAR OIL..400 LB	\$ 1002.00
SHE:OMALA-100-P	INDUSTRIAL GEAR OIL..35 LB	\$ 98.38
SHE:OMALA-S2G150-P	INDUSTRIAL GEAR OIL..35 LB	\$ 106.13
SHE:OMALA-S2G150-D	INDUSTRIAL GEAR OIL..400 LB	\$ 1054.24
SHE:OMALA-S2G220-P	INDUSTRIAL GEAR OIL..35 LB	\$ 89.56
SHE:OMALA-220-D	INDUSTRIAL GEAR OIL..400 LB	\$ 1025.48
SHE:OMALA-320-P	INDUSTRIAL GEAR OIL..35 LB	\$ 99.77
SHE:OMALAS2G320-D	INDUSTRIAL GEAR OIL..400 LB	\$ 923.71
SHE:OMALA-S2G460-P	INDUSTRIAL GEAR OIL..35 LB	\$ 110.00
SHE:OMALA-460-D	INDUSTRIAL GEAR OIL..400 LB	\$ 1012.83
SHE:OMALA-S2G680-P	INDUSTRIAL GEAR OIL..35 LB	\$ 114.23



PARKER, BROTHERS, INC.



LUBRICANTS

INDUSTRIAL GEAR OIL

Mystik® Industrial EP Gear Lubricants

Mystik® Power Lubricants™ Industrial EP Gear Lubricants are GL-2 through GL-4 performance level products exhibiting a 60 pound Timken Load. They are multi-service industrial EP gear lubricants for a wide variety of applications and are manufactured from high quality base stocks and superior additive technology. They are recommended for industrial hypoid gears in non-severe service, manual transmissions and spiral bevel axles requiring mild EP compounding, enclosed gear units, plain and antifriction bearings, gear reducers, and many other applications where an industrial EP gear lubricant is specified.



MYS:IND-EP 100-P	INDUSTRIAL GEAR OIL..35 LB	\$ 77.86
MYS:IND-EP 150-P	INDUSTRIAL GEAR OIL..35 LB	\$ 77.86
MYS:IND-EP 220-P	INDUSTRIAL GEAR OIL..35 LB	\$ 77.86
MYS:IND-EP 460-P	INDUSTRIAL GEAR OIL..35 LB	\$ 77.86
MYS:IND-EP 680-P	INDUSTRIAL GEAR OIL..35 LB	\$ 77.86

Shell OMALA® HD Oils

Shell OMALA HD Oils use the highest quality synthetic (PAO) base stocks available. These base fluids, coupled with carefully selected additives, offer performance far superior to gear oils that are blended from conventional base stocks. Shell OMALA HD Oils are designed for use in industrial gear reducer systems that encounter high or wide ranging temperatures and heavy loading. These oils are also well suited for "sealed for life" systems. OMALA HD Oils help extend drain intervals, improve system cleanliness and reduce maintenance costs. They are compatible with the elastomers, gaskets, seals and paints that are normally used in systems designed for conventional mineral oils. Systems require very little clean up before being switched to OMALA HD Oils.



SHE:OMALA-HD220-P	SYNTHETIC INDUSTRIAL GEAR OIL..35 LB	\$ 217.72
SHE:OMALA-HD320-P	SYNTHETIC INDUSTRIAL GEAR OIL..35 LB	\$ 229.72
SHE:OMALA-HD460-P	SYNTHETIC INDUSTRIAL GEAR OIL..35 LB	\$ 239.40

Shell MORLINA® SB4 Oils (Formally OMALA RL oils)

Shell MORLINA SB4 Oils are produced using highest quality synthetic (PAO) base fluids along with carefully selected additives. These products offer performance properties far superior to those of bearing and gear oils blended from conventional petroleum oils. Shell MORLINA SB4 Oils are designed for use in enclosed and lightly loaded industrial gear reducer system operating under severe operating conditions, such as high temperatures, wide temperature variations and long oil servicing intervals. They are particularly recommended for "sealed-for-



SHE:MORLINA-S4B150-P	SYNTHETIC INDUSTRIAL GEAR OIL..35 LB	\$ 224.17
SHE:OMALA-RL150-D	SYNTHETIC INDUSTRIAL GEAR OIL..400 LB	\$ 2,267.92
SHE:MORLINA-S4B220-P	SYNTHETIC INDUSTRIAL GEAR OIL..35 LB	\$ 215.85
SHE:OMALA-RL220-D	SYNTHETIC INDUSTRIAL GEAR OIL..400 LB	\$ 2,139.02
SHE:OMALA-S4GX460-P	SYNTHETIC INDUSTRIAL GEAR OIL..35 LB	\$ 234.68
SHE:OMALA-RL460-D	SYNTHETIC INDUSTRIAL GEAR OIL..400 LB	\$ 2,432.10
SHE:OMALA-RL680-P	SYNTHETIC INDUSTRIAL GEAR OIL..35 LB	\$ 242.11

Shell OMALA S4 (Formally TIVELA) Fluids

Shell Tivela Fluid are high performance synthetic lubricants that were developed in cooperation with major gear manufacturers. They are recommended for primarily for industrial worm gear lubrication, but may be considered a general purpose gear lubricant for critical applications. The Shell Tivela Fluids are based on polyalkylene glycol (PAG) synthetic based fluids that provide excellent thermal and oxidative stability, load carrying capability and sludge free performance over a wide range of temperatures. In addition, the Shell Tivela Fluids have low foaming tendencies and good rust protection -- even in salt water environments.

SHE:OMALAS4-WE220-P	SYNTHETIC INDUSTRIAL GEAR OIL..5 GAL	\$ 310.30
SHE:TIVELA-S320-P	SYNTHETIC INDUSTRIAL GEAR OIL..5 GAL	\$ 231.56
SHE:TIVELA-S320-D	SYNTHETIC INDUSTRIAL GEAR OIL..55 GAL	\$ 2,052.17
SHE:TIVELA-S460-P	SYNTHETIC INDUSTRIAL GEAR OIL..5 GAL	\$ 273.18

Mystik® Worm Gear Oils

These are premium quality, high viscosity, highly lubricating worm gear oils compounded with acidless tallow. They are excellent lubricants for worm gear reducers using bronze alloy worm "wheels". They also are highly recommended as high quality steam cylinder lubricants.

MYS:WORM-680-P	WORM GEAR OIL..5 GAL	\$ 64.33
----------------	----------------------	----------

FOR 50+ YEARS,
PARKER
BROTHERS
HAS BEEN
SERVING ATLANTA.
THANK YOU FOR
YOUR CONTINUED
SUPPORT!!



LUBRICANTS



INDUSTRIAL GEAR OIL

Shell MORLINA Oils

Shell Morlina Oils are manufactured from carefully selected, premium quality high viscosity index paraffinic base oil, and a combination of premium rust, corrosion, and oxidation inhibitors. These oils exhibit excellent water separation characteristics and extremely low foaming tendencies. Shell Morlina Oils are intended for use in enclosed bath, splash and circulating systems. They are recommended for the lubrication of plain and rolling bearings, slides, machine tools and in low to normally loaded enclosed gear reducers where non-EP AGMA oils are specified.

SHE:MORLINA-100-P	INDUSTRIAL GEAR OIL..35 LB	\$ 85.64
SHE:MORLINA-100-D	INDUSTRIAL GEAR OIL..400 LB	\$ 856.14
SHE:MORLINA-150-D	INDUSTRIAL GEAR OIL..400 LB	\$ 836.55
SHE:MORLINA-220-P	INDUSTRIAL GEAR OIL..35 LB	\$ 85.65
SHE:MORLINA-220-D	INDUSTRIAL GEAR OIL..400 LB	\$ 895.13
SHE:MORLINA-320-D	INDUSTRIAL GEAR OIL..400 LB	\$ 858.83
SHE:MORLINA-460-D	INDUSTRIAL GEAR OIL..400 LB	\$ 873.67

Shell MORLINA SD Oils

Shell Morlina SD Oils are premium quality rust and oxidation inhibited lubricating oils providing excellent lubrication in 'Morgoil' bearings and steel mill circulating systems. They are designed to have appropriate viscosity/temperature characteristics, low foaming tendencies and excellent water separation properties. In addition, they protect equipment against corrosion and oil oxidation resulting in long service life. They are recommended for the lubrication of plain and rolling bearings and spur, helical, bevel, and worm gearboxes where non-EP rust and oxidation oil is approved.

SHE:MORLINA-SD100-P	R & O CIRCULATING OIL..5 GAL	\$ 99.46
SHE:MORLINA-SD100-D	R & O CIRCULATING OIL..55 GAL	\$ 1,044.44
SHE:MORLINA-SD150-P	R & O CIRCULATING OIL..5 GAL	\$ 96.66
SHE:MORLINA-S3BA 150-D	R & O CIRCULATING OIL..55 GAL	\$ 940.01
SHE:MORLINA-SD220-P	R & O CIRCULATING OIL..5 GAL	\$ 99.76

AIR COMPRESSOR OIL

Shell CORENA® AS Oils

Shell CORENAAS Oils are synthetic lubricants designed for the lubrication of compressors. They are formulated with the highest quality PAO base stocks and the most technologically advanced additives. This series is intended for the lubrication of rotary vane, rotary screw, reciprocating and centrifugal air compressors where fluids of these viscosities are recommended.

SHE:CORENA-AS32-P	SYNTHETIC AIR COMPRESSOR OIL..5 GAL	\$ 205.67
SHE:CORENA-AS32-D	SYNTHETIC AIR COMPRESSOR OIL..55 GAL	\$ 1,837.55
SHE:CORENA-S4R46-P	SYNTHETIC AIR COMPRESSOR OIL..55 GAL	\$ 218.19
SHE:CORENA-AS46-D	SYNTHETIC AIR COMPRESSOR OIL..55 GAL	\$ 1,841.12
SHE:CORENA-AS68-P	SYNTHETIC AIR COMPRESSOR OIL..5 GAL	\$ 205.82
SHE:CORENA-AS68-D	SYNTHETIC AIR COMPRESSOR OIL..55 GAL	\$ 1,836.12

Mystik® SynGuard™ Synthetic Industrial Oils

These oils are made from a synthetic diester base and are naturally wax free with a natural solvency. They offer long life, up to 8 times longer than petroleum oil in contamination free environments. They are inhibited with antiwear, rust and oxidation additives and are compatible with petroleum oils. Their application is in air compressors, hydraulic systems, and industrial systems where R&O turbine or circulating oil is specified.

MYS:SYN-IS068-P	SYNTHETIC INDUSTRIAL OIL..5 GAL	\$ 145.24
MYS:SYN-IS068-D	SYNTHETIC INDUSTRIAL OIL..55 GAL	\$ 1,531.88

Shell CORENA® Fluids

Shell CORENA Fluids are synthetic lubricants designed for the lubrication of reciprocating compressors. They are formulated with the highest quality diester base stocks and the most technologically advanced additives. This series is intended for the lubrication of both the crankcase and the cylinders of reciprocating compressors.

SHE:CORENA-AP 100-P	SYNTHETIC AIR COMPRESSOR OIL..5 GAL	\$ 276.98
---------------------	-------------------------------------	-----------

Conventional Air Compressor Oil

CRC:SL22133	30WT. AIR COMPRESSOR OIL...1 GAL	\$ 21.66
-------------	----------------------------------	----------



Mystik
LUBRICANTS

MONDAY-FRIDAY
8am-5pm a helpful
HUMAN voice will
always answer the
phone
(770)474-1286



LUBRICANTS

REFRIGERATION OIL

Shell CLAVUS® Oils

Shell CLAVUS Oils are medium viscosity mineral oils. They have a low pour point and are recommended for lubrication of all refrigeration and air conditioning compressors.

SHE:CLAVUS-68-D	REFRIGERATION COMPRESSOR OIL..55 GAL	\$ 507.50
-----------------	--------------------------------------	-----------

Other Brands

HAVOLINE

HAV:CAPELLA-68-G	REFRIGATION COMPRESSOR OIL..6 / 1 GAL	\$ 70.25
------------------	---------------------------------------	----------

TURBINE OIL

Shell TURBO® T Oils

Shell TURBO T Oils are premium quality turbine, hydraulic and circulating oils designed to provide excellent lubrication of precision turbines in industrial and marine service. Shell TURBO T Oil 32 is widely used for the lubrication of electrical power generation turbines. It has accumulated more than 40 years of excellent performance in major U.S. steam and industrial gas turbines, including those manufactured by General Electric and Westinghouse. Shell TURBO T Oils are premium rust and oxidation inhibited oils for general plant bearing and gear lubrication.

SHE:TURBO-T32-P	TURBINE OIL..55 GAL	\$ 96.98
SHE:TURBO-T32-D	TURBINE OIL..55 GAL	\$ 956.18
SHE:TURBO-T46-P	TURBINE OIL..5 GAL	\$ 98.00
SHE:TURBO-T46-D	TURBINE OIL..55 GAL	\$ 936.63
SHE:TURBO-T68-D	TURBINE OIL..55 GAL	\$ 911.65
SHE:TURBO-T100-D	TURBINE OIL..55 GAL	\$ 923.89

Mystik® Turbax™ Industrial Oils

Mystik® Power Lubricants™ Turbax™ Industrial Oils are available in ISO grades 10 to 460 including the ISO 32 and 68 grades specified by steam and gas turbine manufacturers like General Electric and Westinghouse. Mystik® Turbax™ Industrial Oils are recommended for use in steam and gas turbines and will provide excellent service in these applications as well as other industrial applications calling for a circulating or turbine-type R&O oil

MYS:TURBAX-32-P	TURBINE OIL..5 GAL	\$ 64.34
-----------------	--------------------	----------

Other Brands

CHEVRON

CHE:GST100-P	TURBINE OIL..5 GAL	\$ 96.11
CHE:GST100-D	TURBINE OIL..55 GAL	\$ 1046.43
CHE:TURBAX150-P	TURBINE OIL..5 GAL	\$ 43.51

AVIATION LUBRICANTS

Anti-corrosion Antiwear AEROSHELL® Oil W 15W-50 Multigrade

Anti-corrosion Antiwear AEROSHELL Oil W 15W-50 is an advanced formula semi-synthetic, ashless, highly dispersant multigrade oil for 4-stroke cycle certificated aircraft piston engines that offers an exceptionally broad viscosity grade range. This premium quality oil contains over 50% synthetic base stocks to insure excellent low temperature flow to speed cold starts while lubricating and protecting critical engine parts during warm up; yet, at high temperatures, it offers engine protection that is superior to a Grade 100 (SAE 50 oil).

SHE:AERO-15W50-C	AVIATION MOTOR OIL..12 / 1 QT	\$ 95.13
SHE:AERO-15W50-D	AVIATION MOTOR OIL..55 GAL	\$ 1622.91

AEROSHELL~ Oil W Single Grade Oils

AEROSHELL Oil W Single Grade Oils are premium ashless dispersant lubricating oils for 4-stroke cycle certificated aircraft piston engines. They have been proven in billions of engine hours around the world, including service in fuel-injected and turbocharged engines.

SHE:AERO-W100-D	ASHLESS AVIATION MOTOR OIL..55 GAL	\$ 1264.34
SHE:AERO-W120-D	ASHLESS AVIATION MOTOR OIL..55 GAL	\$ 1264.34



Parker Brothers
gladly accepts
Visa, Mastercard
Discover &
American Express



LUBRICANTS



AVIATION LUBRICANTS

AEROSHELL~ Fluid 41

AEROSHELL Fluid 41 is a mineral based aircraft hydraulic oil with excellent low temperature characteristics that is capable of operating over a wide range of temperatures. This fluid is oxidation inhibited, and contains a special anti-wear additive. It is dyed red for identification and leak detection purposes. AEROSHELL Fluid 41 can be used in both aviation and non-aviation systems with synthetic rubber components, but should not be used in systems that incorporate natural rubber.

SHE:AERO-FL41-G	AVIATION HYDRAULIC OIL..6 / 1GAL	\$ 206.45
-----------------	----------------------------------	-----------

Other Brands

HAVOLINE

HAV:HYD-15-G	AVIATION HYDRAULIC OIL..6 / 1GAL	\$ 113.72
--------------	----------------------------------	-----------

AEROSHELL~ Greases

These AEROSHELL Greases are formulated with MICROGEL® thickener, a high temperature, non-melting inorganic thickener.

AEROSHELL Grease 5: For wheel bearings and engine accessories that operate at high speeds and relatively high temperatures.

AEROSHELL Grease 6: General purpose airframe grease for use in plain and antifriction bearings and gearboxes. Provides good water resistance and has low noise capabilities.

AEROSHELL Grease 7: Wide temperature range, synthetic, multipurpose grease for highly loaded gears and actuator screw mechanisms. Also recommended for instruments and general airframe lubrication of turbine powered aircraft.

SHE:AERO-5-P	AVIATION GREASE..35 LB	\$ 261.94
SHE:AERO-6-P	AVIATION GREASE..35 LB	\$ 215.88
SHE:AERO-7-P	AVIATION GREASE..35 LB	\$ 539.41



MARINE LUBRICANTS

Shell NAUTILUS~ 2-Cycle Outboard Marine Oil

Shell NAUTILUS 2-Cycle Outboard Marine Oil is formulated from premium base oils and technically advanced ashless additives for severe service conditions encountered by 2-cycle marine engines. Nautilus 2-cycle Outboard Marine Oil contains dye to assist in identifying gasoline / oil pre-mixed fuel

SHE:NAUTILUS-C	MARINE 2 CYCLE OIL..12 / 1QT	\$ 58.54
SHE:NAUTILUS-G	MARINE 2 CYCLE OIL..1GAL	\$ 19.05

Mystik® Precision Blue® Marine Wheel Bearing Grease

Mystik® Precision Blue® Marine Wheel Bearing Grease is highly recommended for boat trailer wheel bearings, greased chassis points, fifth wheels, and water pumps. It provides excellent protection against saltwater conditions, extreme pressures, shock loading, and vibration. It is fortified with additives to resist rust, corrosion, oxidation, and wear, and is recognized by many as the best marine wheel bearing grease on the market today because of its superior protection and water washout resistance!

MYS:MAR-1LB	MARINE WHEEL BEARING GREASE..1LB	\$ 2.27
MYS:JT6-HP-MARINE-1T	HI TEMP MARINE GREASE..50 / 14 OZ TUBES	\$ 25.12

Mystik® Precision Blue® Marine Gear Lubricant

Mystik® Precision Blue® Marine Gear Lubricant SAE 80W-90 provides maximum protection against rust, corrosion, deposits, and wear. It is recommended for use in any outboard gear case or inboard/outboard stern drive which specifies an SAE 80W-90 or SAE 90 viscosity grade.

MYS:MAR-80W90-1T	MARINE GEAR OIL..10 OZ TUBE	\$ 6.45
------------------	-----------------------------	---------

2-CYCLE OIL

Mystik® JT4 2 Cycle Oil

Mystik® JT4 2 cycle oil is a high performance oil engineered for two-cycle chain saw engines. It is formulated to prevent excessive wear and cut deposits to a minimum. It prevents plug fouling, port plugging, ring sticking, and maintains engine cleanliness.

MYS:CHAIN-SAW-D	2 CYCLE OIL..55 GAL	\$ 669.90
MYS:JT4-2CYCLE-D	2 CYCLE OIL..55 GAL	\$ 855.72
MYS:JT4-2CYCLE-L&G-C	2 CYCLE OIL..4 / 1GAL	\$ 50.51
MYS:JT4-2CYCLE-OBMO-G	PREMIUM 2 CYCLE OIL PLUS OBMO..4 / 1GAL	\$ 91.92
MYS:JT4-2CYCLE-PWC-4G	2 CYCLE OIL..4 / 1GAL	\$ 97.68
MYS:JT4-2CYCLE-QT	2 CYCLE 12 / 1QTS	\$ 4.26

FOR 50+ YEARS,
PARKER
BROTHERS
HAS BEEN
SERVING ATLANTA.
**THANK YOU FOR
YOUR CONTINUED
SUPPORT!!**





LUBRICANTS

2-CYCLE OIL

Other Brands

PUREGUARD

P/G:2-CYCLE-6.4	2 CYCLE OIL..24 / 6.4 OZ BOTTLES	\$ 25.95
-----------------	----------------------------------	----------

BAR AND CHAIN OIL

Mystik® Bar and Chain Lubricant

Mystik® Bar and Chain Lubricant is designed to effectively lubricate the cutter bar and chain of Homelite, Husqvarna, Poulan, Pioneer, Stihl, McCulloch and other leading chain saw brands. It is the choice of many logging industry professionals.

MYS:BAR-CHAIN-C	BAR AND CHAIN OIL..12 / 1 QT	\$ 52.81
MYS:BAR-CHAIN-G	BAR AND CHAIN OIL..6 / 1 GAL	\$ 58.69
MYS:BAR-CHAIN-D	BAR AND CHAIN OIL..55 GAL	\$ 566.23

PURE GUARD

P/G:BAR-CHAIN-3G	BAR AND CHAIN OIL..3 / 1 GAL	\$ 34.38
------------------	------------------------------	----------

FOOD GRADE LUBRICANTS

Mystik® FG/FM Food Machinery Oils

Mystik® FG/FM Food Machinery Oils will effectively lubricate most food processing and packaging machinery. They are blended from exceptional quality, high viscosity index, paraffinic Food Grade White Mineral Oils that surpass the FDA requirements of 21 CFR 172.878 and 178.3620(a) and pass the USP requirements in the Lead Oxide Test. Finished products are in accordance with 21 CFR 178.3570 "Lubricants with incidental food contact. They are light colored, nonstaining and essentially odorless and tasteless. Mystik® FG/FM Food Machinery Oils are oxidation inhibited for enhanced stability and will provide functional performance superior to typical technical grade white oils used in the food industry.

MYS:FG-FM 15-P	FOOD GRADE WHITE MINERAL OIL..5 GAL	\$ 609.06
MYS:FG-FM 32-D	FOOD GRADE WHITE MINERAL OIL..55 GAL	\$ 52.98
MYS:FG-FM 68-D	FOOD GRADE WHITE MINERAL OIL..55 GAL	\$ 0.33
MYS:FG-FM 100-P	FOOD GRADE WHITE MINERAL OIL..5 GAL	\$ 658.35

Other Brands

CITGO

CIT:DUOPRIME-70-D	FOOD GRADE WHITE MINERAL OIL..55 GAL	\$ 462.55
CIT:DUOPRIME-200-D	FOOD GRADE WHITE MINERAL OIL..55 GAL	\$ 530.33

Mystik® FG-2 Food Machinery Grease

Mystik® FG-2 effectively lubricates most machinery used to manufacture, process, package and store food products. The approximate temperature range of this NLGI No. 2 grease is 0 to 275°F. (-18 to +135°C.). Mystik® FG-2 is very resistant to water washout and is water insoluble. The texture is smooth, buttery, and stringy, and the grease has a neutral mild petroleum odor. The color is clear with a slight cloud and no pigments are used; therefore, the grease is nonstaining.

MYS:FG2-1T	FOOD GRADE GREASE..14 OZ TUBE	\$ 3.17
------------	-------------------------------	---------

Mystik® HT-FG Supreme Food Machinery Greases

Mystik® HT-FG Supreme Food Machinery Greases are high temperature, polymer-fortified, food machinery greases with excellent EP (40 pound Timken OK Load) and antiwear performance. They are engineered specifically for food processing and packaging machinery, rust and oxidation inhibited, water insoluble and very resistant to water washout. They have superior high temperature performance and good adhesion/cohesion properties. The approximate temperature range of these greases is 10 to 325°F. They have a neutral mild petroleum odor and are nonstaining. Mystik® HT-FG Food Machinery Greases are the Supreme high temperature food machinery greases

MYS:FG-HI-T-1T	FOOD GRADE HI-TEMPERATURE GREASE..14 OZ TUBE	\$ 2.12
----------------	--	---------

Food Grade Hydraulic Oil

MYS:FGAW32-D	FOOD GRADE HYDRAULIC OIL..55 GAL	\$ 284.46
--------------	----------------------------------	-----------



MONDAY-FRIDAY
8am-5pm a helpful
HUMAN voice will
always answer the
phone
(770)474-1286



PARKER, BROTHERS, INC.

LUBRICANTS



WAY OIL

Shell TONNA® V Oils

Shell TONNA V Oils are premium grade oils for lubrication of relatively slow machine tool slideway components. These lubricants contain friction modifying additives that provide smooth slideway movement, or "anti-stick-slip" properties. These oils contain a tackiness additive for excellent adhesive properties.

SHE:TONNA-V68-D	WAY OIL..55 GAL	\$ 874.85
SHE:TONNA-V220-P	WAY OIL..5 GAL	\$ 87.36
SHE:TONNA-V220-D	WAY OIL..55 GAL	\$ 874.85

Other Brands

CHEVRON

CHE:VISTAC-32-D	WAY OIL..55 GAL	\$ 100.29
CHE:VISTAC-68-P	WAY OIL..5 GAL	\$ 102.91
CHE:VISTAC-320-P	WAY OIL..5 GAL	\$ 81.05

CITGO

CIT:SLIDERITE-68-D	WAY OIL..55 GAL	\$ 700.21
--------------------	-----------------	-----------

TOOL OIL

Mystik® Rock Drill Oils

Mystik® Power Lubricants™ Rock Drill Oils provide excellent extreme pressure (EP) and anti-wear performance in heavy duty pneumatic tools. They may also be used as high quality industrial slideway lubricants (way oils) or non-drip oils.

MYS:ROCK-DRILL-P	ROCK DRILL OIL..5 GAL	\$ 61.49
------------------	-----------------------	----------

METAL WORKING FLUID

Mystik® Soluble Oil

The compounding enables the oil to be mixed with water into a stable, milk-white fluid. The water in the mixture provides excellent cooling of cutting tools because of water's superior natural ability to transfer heat. The oil provides lubrication to the cutting tool and also retards the hazards of corrosion possible because of the presence of water.

MYS:SOLUBLE-P	SOLUBLE OIL..5 GAL	\$ 64.88
---------------	--------------------	----------

Other Brands

CHEVRON

CHE:503-P	METAL WORKING FLUID..5 GAL	\$ 63.13
CHE:SOLUBLE-P	SOLUBLE OIL..5 GAL	\$ 96.95

SHELL

SHE:DROM US201-P	SOLUBLE OIL..55 GAL	\$ 93.90
SHE:DROM US201-D	SOLUBLE OIL..55 GAL	\$ 999.08

Cutting Oils

LPS

LPS:01216	TAPMATIC AQUACUT CUTTING FLUID..16 OZ BOTTLE	\$ 13.01
LPS:01228	TAPMATIC AQUACUT CUTTING FLUID..1 GAL	\$ 36.81
LPS:01205	TAPMATIC AQUACUT CUTTING FLUID..5 GAL	\$ 135.55
LPS:40312	TAPMATIC#1 GOLD CUTTING FLUID..11 OZ AEROSOL	\$ 10.55
LPS:43100	TAPMATIC EDGE CUTTING CREAM..11 OZ TUBE	\$ 16.92
LPS:43200	TAPMATIC EDGE CUTTING LUBE..13 OZ TUBE	\$ 16.92
LPS:44220	TAPMATIC NATURAL CUTTING FLUID..16 OZ BOTTLE	\$ 11.86
LPS:44230	TAPMATIC NATURAL CUTTING FLUID..1 GAL	\$ 52.57

SPINDLE OIL

Shell SPINDLE Oils

Shell SPINDLE Oils are manufactured with carefully selected, premium quality base oils and a premium combination of high quality rust, corrosion and oxidation inhibitors. These oils also exhibit excellent water separation characteristics and extremely low foaming tendencies. Shell SPINDLE Oils are intended for use in the high speed spindle bearings found in some modern textile machines and other machine tools. These types of bearings may operate at extremely high rpms, and they are likely to require low viscosity oils to lubricate properly and to dissipate excessive heat that may be generated.

SHE:SPINDLE-10-P	HIGH SPEED BEARING OIL..5 GAL	\$ 79.98
SHE:SPINDLE-10-D	HIGH SPEED BEARING OIL..55 GAL	\$ 737.38
SHE:SPINDLE-22-P	HIGH SPEED BEARING OIL..55 GAL	\$ 82.13



FOR 50+ YEARS,
PARKER
BROTHERS
HAS BEEN
SERVING ATLANTA.
THANK YOU FOR
YOUR CONTINUED
SUPPORT!!





LUBRICANTS

ELECTRICAL OIL

Shell DIALA® Oils A & AX

Shell DIALA Oils A & AX are electrical insulating oils. They meet the standard specifications required by both ANSI/ASTM D 3487 and NEMA TR-P8-1975 for domestic electrical oil applications. These products have high electrical resistance and are thermally and oxidatively stable. They are intended for use in transformers, circuit breakers, oil filled switches and in X-ray equipment.

SHE:DIALA-AX-D	ELECTRICAL INSULATING OIL..55 GAL	\$ 908.35
----------------	-----------------------------------	-----------



HEAT TRANSFER OIL

Shell THERMIA® Oil C

Shell THERMIA Oil C is a specially selected, thermally stable mineral oil that contains an antioxidant designed for the high temperatures found in heat transfer applications. Shell THERMIA Oil C is recommended for closed heat transfer systems used in asphalt plants, chemical plants and other processing installations that experience temperatures up to 550°F with occasional spikes to 600°F.

SHE:THERMIA-C-P	HEAT TRANSFER OIL..5 GAL	\$ 74.67
SHE:THERMIA-C-D	HEAT TRANSFER OIL..55 GAL	\$ 826.21



TEXTILE OIL

Shell ONDINA Oil 22

Shell ONDINA Oil 22 is a water-white oil blended from highly refined mineral oil. It is intended for use as a lubricant in the textile industry, as a slitter oil in the paper industry or any other industry where oil may accidentally spill on fabric or paper and must not cause a stain.

SHE:ONDINA-22-D	NON STAINING TEXTILE OIL..55 GAL	\$ 1,284.26
-----------------	----------------------------------	-------------

MISCELLANEOUS OIL

Hydraulic Jack Oil

MYSTIK

MYS:JACK-OIL-Q	HYDRAULIC JACK OIL..1 QT	\$ 4.87
----------------	--------------------------	---------

Undercoating

KENDALL

KEN:701-7913	UNDER BODY PROTECTIVE COATING..16 GAL	\$ 196.01
--------------	---------------------------------------	-----------

SOLDER SEAL/GUNK

SSG:T 16-16	TITSEAL UNDERCOATING..16 OZ AEROSOL	\$ 5.42
-------------	-------------------------------------	---------

3M

3M:08881	BLACK UNDERCOATING..16 OZ. AEROSOL CAN	\$ 5.72
----------	--	---------

PERMATEX

PER:81833	UNDER COATING..16 OZ AEROSOL	\$ 9.39
-----------	------------------------------	---------



BRAKE FLUID

Dot 3 Brake Fluid

P/G:BRK-FL-12OZ	DOT 3 BRAKE FLUID..1 GAL	\$ 2.05
P/G:BRK-FL-QT	DOT 3 BRAKE FLUID..1 QT	\$ 4.55
P/G:BRK-FL-1G	DOT 3 BRAKE FLUID..5 GAL	\$ 22.55
SSG:M 44-12	DOT 3 BRAKE FLUID..12 OZ BOTTLE	\$ 1.83
SSG:M 44-32	DOT 3 BRAKE FLUID..1 QT	\$ 4.26
SSG:M 44-34	DOT 3 BRAKE FLUID..1 GAL	\$ 16.41

Dot 4 Brake Fluid

CAS:LM A -12OZ	DOT 4 BRAKE FLUID..12 OZ	\$ 3.50
CAS:LM A -QT	DOT 4 BRAKE FLUID..1 QT	\$ 9.05
SSG:M 45-12	DOT 4 BRAKE FLUID..12 OZ BOTTLE	\$ 2.79
SSG:M 45-32	DOT 4 BRAKE FLUID..1 QT	\$ 5.96

Dot 5 Silicone Brake Fluid

PRI:7012	SILICONE BRAKE FLUID..12 OZ BOTTLE	\$ 6.65
NAC:NA 40	SILICONE BRAKE FLUID..1 QT	\$ 11.70



Parker Brothers
gladly accepts
Visa, Mastercard
Discover &
American Express

LUBRICANTS



POWER STEERING FLUID

Power Steering Fluid

P/G:P-STEER-12OZ	POWER STEERING FLUID..12 OZ BOTTLE	\$ 1.75
P/G:P-STEER-QT	POWER STEERING FLUID..1 QT	\$ 2.44
SSG:M 27-13	POWER STEERING FLUID..12 OZ BOTTLE	\$ 1.85
SSG:M 27-32	POWER STEERING FLUID..1 QT	\$ 4.16
SSG:M 27-34	POWER STEERING FLUID..1 GAL	\$ 14.93
SSG:M 27-40	POWER STEERING FLUID..5 GAL	\$ 7.74

Gunk Honda Power Steering Fluid

SSG:M 27-14	HONDA POWER STEERING FLUID..12 OZ BOTTLE	\$ 2.76
-------------	--	---------

ANTIFREEZE

Full Force Antifreeze

Formulated to be the only antifreeze you need. It provides maximum protection for the aluminum cooling system in your automobile and is a low silicate product for the heavy duty diesel applications.

ANT:FULL-FORCE-G	GREEN ANTIFREEZE..6 / 1 GAL	\$ 60.91
ANT:FULL-FORCE-D	GREEN ANTIFREEZE ..55 GAL	\$ 542.31

Pre-Mixed Antifreeze

No need to add water!! Ready to go antifreeze!

ANT:PRE-MIX-D	50/50 GREEN ANTIFREEZE..55 GAL	\$ 325.05
---------------	--------------------------------	-----------

Extended Life Antifreeze

NEW!! Long life antifreeze. 150,000 Miles! Peak's extended life antifreeze is compatible with ALL extended life antifreeze. It's amber color will not change the appearance of the original antifreeze. It is "GOOF PROOF".

ANT:LL-FULLFORCE-G	EXTENDED LIFE ANTIFREEZE..6 / 1 GAL	\$ 63.94
ANT:LL-FULLFORCE-D	EXTENDED LIFE ANTIFREEZE..55 GAL	\$ 570.20
ANT:EXT-LIFE-G	PEAK EXTENDED LIFE ANTIFREEZE..6 / 1 GAL	\$ 80.74
ANT:EXT-LIFE-D	PEAK EXTENDED LIFE ANTIFREEZE..55 GAL	\$ 765.60
ANT:DEXCOOL-G	HAVOLINE EXTENDED LIFE ANTIFREEZE..6 / 1 GAL	\$ 94.21
HAV:DEXCOOL-C	EXTENDED LIFE ANTIFREEZE..6 / 1 GAL	\$ 80.64
HAV:DEXCOOL-D	EXTENDED LIFE ANTIFREEZE..55 GAL	\$ 831.32

Low Toxic Antifreeze

Less toxic, more environmentally friendly antifreeze

ANT:LO-TOX-C	BIO SAFE ANTIFREEZE..6 / 1 GAL	\$ 106.88
--------------	--------------------------------	-----------

Pre-Charged Antifreeze

Never mess with SCA'S again! Fleet Charge fully formulated antifreeze is designed to provide superior engine protection for heavy duty diesel cooling systems. Correctly charged for initial fills and top offs.

ANT:FLEET-CHG-D	50/50 PRE CHARGED ANTIFREEZE..55 GAL	\$ 413.14
-----------------	--------------------------------------	-----------

Shell ROTELLA ELC EXTENDED LIFE Coolant/Antifreeze

Shell ROTELLA ELC EXTENDED LIFE Coolant/Antifreeze is a "fill fo life" ethylene glycol based coolant for heavy-duty diesel, gasoline and natural gas engines. Rotella ELC contains a unique extended life carboxylate inhibitor system and nitrite/molybdate as secondary inhibitors. This product contains no silicates, borate, nitrate or phosphate and requires no traditional SCA additions. It meets all requirements of CAT EC-1, TMC RP338. Proven with over a 100 million miles of fleet testing. 50/50 premix, no need to add water. Ready to go!!

SHE:ELC-50/50-G	50/50 PRE CHARGED EXTENDED LIFE ANTIFREEZE..6 / 1 GAL	\$ 76.72
SHE:ELC-50/50-D	50/50 PRE CHARGED EXTENDED LIFE ANTIFREEZE..55 GAL	\$ 529.56

Other Brands

FULL FORCE

ANT:FINAL-CHG-G	50/50 PRE CHARGED EXTENDED LIFE ANTIFREEZE ..6 / 1 GAL	\$ 58.29
ANT:FINAL-CHG-D	50/50 PRE CHARGED EXTENDED LIFE ANTIFREEZE ..55 GAL	\$ 518.37

RV Antifreeze

Used in RV commodes, water filled tires, and other applications to keep water from freezing.

ANT:RV-C	RV ANTIFREEZE ..6 / 1 GAL	\$ 32.10
ANT:RV-D	RV ANTIFREEZE ..55 GAL	\$ 334.13





LUBRICANTS

OIL ANALYSIS

Oil Analysis

SHELL

SHE:OIL ANALYSIS K3

OIL ANALYSIS KIT..1EACH

\$ 24.27



FOR 50+ YEARS,
PARKER
BROTHERS
HAS BEEN
SERVING ATLANTA.
THANK YOU FOR
YOUR CONTINUED
SUPPORT!!



PARKER, BROTHERS, INC.

PARKER, BROTHERS, INC.

PARKER, BROTHERS, INC.

PARKER, BROTHERS, INC.

PARKER, BROTHERS, INC.

PARKER, BROTHERS, INC.

PARKER, BROTHERS, INC.

LUBRICANTS



ANTIFREEZE PROTECTION CHART

QUARTS OF ANTI-FREEZE/COOLANT REQUIRED TO OBTAIN PROTECTION TO TEMPERATURES GIVEN BELOW (IN DEGREES FAHRENHEIT)

COOLING SYSTEM CAPACITY IN QTS.

	1	2	3	4	5	6	7	8	9	10	11	12	13	14	15	16	18	20	22	24	26	28	30	32	34	36	38	40	50			
6	19	0	-34																													
8	22	10	-8	-34																												
10	25	16	4	-12	-34	-52																										
12		19	10	0	-15	-34	-57																									
14		21	15	6	-5	-18	-34	-54																								
16		22	17	10	2	-8	-19	-34	-52																							
18		24	19	14	7	0	-10	-21	-34	50																						
20		25	20	16	10	4	-3	-12	-22	-34	-48	-62																				
22			21	18	13	8	2	-6	-14	-23	-34	-47	-59																			
24			22	19	15	10	6	0	-8	-15	-24	-34	-46	-57																		
26			23	20	17	13	8	3	-2	-9	-16	-25	-34	-43	-55																	
28			24	21	18	15	10	6	1	-5	-11	-18	-25	-34	-42	-54																
30				22	19	16	13	9	4	0	-6	-12	-19	-26	-34	-42	-62															
32				22	20	17	14	10	7	2	-2	-8	-14	-19	-26	-34	-52	-69														
36				24	21	19	16	14	10	7	4	0	-5	-10	-15	-21	-34	-50	-65													
40					22	20	18	16	13	10	8	4	1	-3	-8	-12	-22	-34	-48	-62												
44					23	21	19	18	15	13	10	8	5	2	-2	-6	-14	-23	-34	-47	-59											
48					24	22	20	19	17	15	13	10	8	6	2	0	-8	-15	-24	-34	-46	-57										
52						23	21	20	18	17	15	13	10	8	6	3	-2	-9	-16	-25	-34	-43	-55	-66								
56							22	21	19	18	16	15	13	10	9	6	1	-5	-11	-18	-25	-34	-42	-54	-64							
60								23	22	20	19	17	16	14	13	10	9	4	0	-6	-12	-19	-26	-34	-42	-53	-62					
64									24	22	21	20	18	17	16	14	12	10	7	2	-2	-8	-14	-19	-26	-34	-41	-52	-60			
68										23	22	20	19	18	17	15	14	12	9	5	1	-4	-9	-14	-20	-27	-34	-41	-51	-58		
72											24	22	21	20	19	18	16	15	14	10	7	4	0	-5	-10	-15	-21	-27	-34	-40	-50	
76												23	22	21	20	19	17	16	15	12	9	6	2	-2	-6	-11	-16	-21	-27	-34	-40	
80													22	21	20	19	18	17	16	13	10	8	4	1	-3	-8	-12	-17	-22	-27	-34	-69

50% CONCENTRATION PROTECTS AGAINST FREEZE-UPS DOWN TO -34F. PROTECTS AGAINST BOILOVER UP TO 265F. USING A 15LB. PRESSURE CAP IN GOOD CONDITION.

API SERVICE CATEGORIES

API Engine Service Categories Gasoline Engines

Category	Oil Description
SA*	Straight mineral oil (no additives)
SB*	Anti-oxidant, anti-scuff, but non-detergent
SC	Protection against high- and low-temperature deposits, wear, rust, corrosion; meets car makers warranty requirements for 1967 and earlier models
SD	Improved protection over SC oils, meets warranty requirements for 1970 and earlier models
SE	Improved protection over SD oils, meets warranty requirements for 1979 and earlier models
SF	Improved anti-wear and anti-oxidation; meets warranty requirements for 1988 and earlier models.
SG	Improved sludge control; meets warranty requirements for 1993 as well as earlier models.
SH	Improved deposit control, oil oxidation, wear, rust and corrosion; meets warranty requirements for most 1997 as well as earlier models.
SJ	Lower phosphorus to protect catalytic converters, lower volatility for some 1997 and all 1998 models
SL	Introduced July 1, 2001. SL oils are designed to provide better high temperature deposit control and lower oil consumption. Some of these oils may also meet the latest ILSAC specification and/or qualify as Energy Conserving.
SM	For all automotive engines currently in use. Introduced November 30, 2004. SM oils are designed to provide improved deposit protection, better wear protection, and better low temperature performance over the life of the oil. Some of these oils may also meet the latest ILSAC specification and/or qualify as Energy Conserving.

API Engine Service Categories Diesel Engines

Category	Oil Description
CF	Severe duty; Turbocharged 4-cycle diesel engines; protection against high-temperature deposits, and corrosion.
CF-2	Severe duty 2-cycle diesel engines, meets Detroit Diesel 6V-92TA engine test requirements.
CF-4	Severe duty turbocharged 4-cycle diesel engines; highest protection against high- and low-temperature deposits, especially including late models (since 1988) lower emission engines: Mack(EO-K/2), Cummins NTC-400, and Caterpillar 1K.
CG-4	Severe duty turbocharged 4-cycle diesel engines; highest protection against high- and low-temperature deposits, for low emission engines since 1994; low sulfur fuel (less than 0.05% sulfur); Mack EO-L, Caterpillar 1N.
CH-4	Introduced 12/1/1998. For high-speed, four stroke engines designed to meet 1998 exhaust emission standards. CH-4 oils are specifically compounded for use with diesel fuels ranging in sulfur content up to 0.5% weight. Can be used in place of CD, CE, CF-4 and CG-4 oils.
CI-4	Introduced 9/5/02. For high-speed, four-stroke engines designed to meet 2004 exhaust emission standards implemented in 2002. CI-4 oils are formulated to sustain engine durability where exhaust gas recirculation (EGR) is used and are intended for use with diesel fuels ranging in sulfur content up to 0.5% weight. Can be used in place of CD, CE, CF-4, CG-4 and CH-4 oils.
CI-4 PLUS	Introduced 9/04. CI-4 PLUS is an update up CI-4. It is primarily for improving soot thickening performance in new low emission vehicles.
CJ-4	Introduced 10/06. For high-speed, four-stroke engines designed to meet 2007 on highway exhaust emission standards. CJ-4 oils are formulated to protect emission control systems, help comply with emission standards, reduce engine wear and control piston deposits and oil consumption. They are intended to maintain oil drain intervals when used with low sulfur diesel fuel



LUBRICANTS

VISCOSITY EQUIVALENTS

ISO	AGMA	SAE CRANKCASE	SAE GEAR
1500			250
1000			
680	8a		140
460	8		
320	7		
220	6		90
150	5	50	
100	4	40	85w
68	3	30	80w
46	2	20w	
32	1	15w	75w
22		10w	
15		5w	
10			
7			
5			
3			
2			

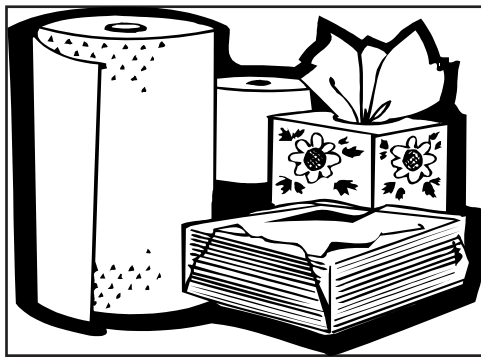

PAPER PRODUCTS

BATHROOM TISSUE
TOILET SEAT PROTECTORS
FACIAL TISSUE
KITCHEN TOWELS
HAND TOWELS
WIPERS
DISPENSERS
BAGS
FOOD SERVICE
MISCELLANEOUS PAPER

PARKER, BROTHERS, INC.

LOVES OUR
CUSTOMERS

THANK YOU
FOR ALL THE GREAT
YEARS!!

IT HAS BEEN OUR
PLEASURE TO SERVE

PARKER, BROTHERS, INC.

PAPER PRODUCTS

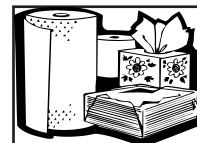

BATHROOM TISSUE

Kimberly-Clark Surpass Bathroom Tissue

Tailored for areas where function is as important as quality. Our Surpass line offers exceptional performance and exceptional value.

K/C:04460	TOILET TISSUE..80 ROLLS / 605 SHEETS PER ROLL	\$ 68.40
K/C:07805	JUNIOR JUMBO TOILET TISSUE..12 ROLLS / 1000' PER ROLL	\$ 91.92

Charmin

Exceptional comfort and strength. Safe for sewer and septic systems. 280/2-ply sheets per roll.

LAG-STOCK:CHARMIN	CHARMIN TOILET TISSUE..40 ROLLS / 352 SHEETS PER ROLL	\$ 48.27
-------------------	---	----------

Other Brands

K/C:17713	COTTONELLE TOILET TISSUE..60 ROLLS / 505 SHEETS PER ROLL	\$ 68.40
LAG-STOCK:12IN.TP	JUMBO TOILET TISSUE..6 ROLLS / 2000' PER ROLL	\$ 37.99
E/P:96ROLL-TP	2 PLY TOILET PAER..96 ROLS..500 SHEETS PER ROLL	\$ 42.01
E/P:9IN.TP	9" JR. JUMBO TOILET PAPER ...1000' PER VROLL...12 ROLLS PER CASE	\$ 24.99
E/P:12IN.TP	12" JUMBO TOILET PAPER ...4000' PER VROLL..6 ROLLS PER CASE	\$ 45.68

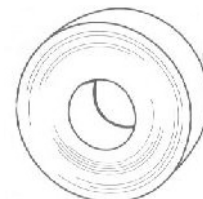

07805
07827



04460

TOILET SEAT PROTECTORS

Kimberly-Clark Surpass Personal Seats

Help protect personal health and keep the environment sanitary with personal toilet seat covers.

K/C:07410	TOILET SEAT PROTECTORS..24 PACKS / 125 COVERS PER PACK	\$ 137.27
-----------	--	-----------

Other Brands

ABC:TCOVERS2500	TOILET SEAT COVERS..2500 PER CASE	\$ 28.43
ABC:TCOVERS5000	TOILET SEAT COVERS..5000 PER CASE	\$ 50.39



FACIAL TISSUE

Kimberly-Clark Kleenex

The finest quality facial tissue on the market.

K/C:21400	KLEENEX FACIAL TISSUE..36 BOXES / 100 TISSUES PER BOX	\$ 66.35
K/C:21269	KLEENEX FACIAL TISSUE..36 BOXES / 95 TISSUES PER BOX	\$ 79.20
K/C:30270	KLEENEX POCKET PACKS..32 PACKS / 15 PER PACK	\$ 30.21



21400

KITCHEN TOWELS

Kimberly-Clark Paper Towels

Economical enough to use every day. 2-ply 11X9 sheets.

K/C:41482	2 PLY KITCHEN PAPER TOWELS..20 ROLLS / 128 SHEETS PER ROLL	\$ 39.00
-----------	--	----------

Bounty Paper Towels

Strong, quick and absorbent. 2-ply 11X11 sheets.

LAG-STOCK:BOUNTY	BOUNTY PAPER TOWELS..30 ROLLS / 60 SHEETS PER CASE	\$ 74.25
------------------	--	----------

Other Brands

E/P:KITCHEN-ROLL	2 PLY KITCHEN PAPER TOWELS..30 ROLLS..80 SHEETS PER ROLL	\$ 26.11
------------------	--	----------



41482

HAND TOWELS

Kimberly-Clark Roll Towels

The most economical way to dry your hands.

K/C:02068	WHITE ROLL TOWELS..12 ROLLS / 8" X 400'	\$ 51.12
K/C:01040	WHITE ROLL TOWELS..12 ROLLS / 8" X 800'	\$ 108.54
K/C:02021	NATURAL ROLL TOWELS..12 ROLLS / 8" X 400'	\$ 42.84
K/C:04142	NATURAL ROLL TOWELS..12 ROLLS / 8" X 800'	\$ 72.18

Other Brands

E/P:BROWNROLL-350	NATURAL ROLL TOWELS..12 ROLLS..8"X350'	\$ 27.58
E/P:WHITEROLL-350	WHITE ROLL TOWELS..12 ROLLS..8"X350'	\$ 39.39
E/P:BROWNROLL-800	NATURAL ROLL TOWELS..6 ROLLS..8"X800'	\$ 40.14
E/P:WHITEROLL-800	WHITE ROLL TOWELS..6 ROLLS..8"X800'	\$ 44.59

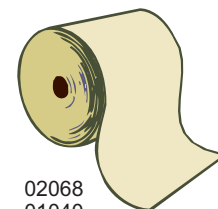

02068
01040
02021
04142

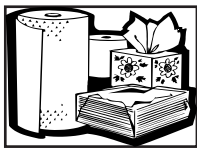

PAPER PRODUCTS

HAND TOWELS

Center Flow Towels

K/C:01010	WHITE CENTER FLOW TOWELS..4 ROLLS / 500 SHEETS PER ROLL	\$ 47.04
K/C:01051	WHITE CENTER FLOW TOWELS..4 ROLLS / 500 SHEETS PER ROLL	\$ 51.84



C-FOLD
01500

Other Brands

E/P :CPULL-WHITE-600	WHITE CENTER FLOWTOWLES..6 ROLLS..600' PER ROLL	\$ 34.19
----------------------	---	----------



MULTI-FOLD
01804
03650

Folded Towels

K/C:01500	C-FOLD TOWELS..2400 PER CASE	\$ 62.43
K/C:01700	SINGLEFOLD TOWELS..4000 PER CASE	\$ 55.20
K/C:01980	M-FOLD TOWELS..4375 PER CASE	\$ 54.75
K/C:01804	MULTI-FOLD TOWELS..4000 PER CASE	\$ 48.24
K/C:03650	MULTI-FOLD TOWELS..3000 PER CASE	\$ 39.78

Other Brands

E/P :CFOLD-WHITE	C-FOLD WHITE TOWEL..2400 PER CASE	\$ 29.33
E/P :MULTIFOLD-WHITE	MULTI-FOLD TOWELS..4000 PER CASE	\$ 26.93

Parker Brothers
gladly accepts
Visa, Mastercard
Discover &
American Express

WIPERS

Kimberly-Clark Light Duty Wipers

These wipers are ideal for polishing chrome, cleaning windshields and interiors, and wiping up liquids.

K/C:05120	2 PLY BLUE WINDSHIELD TOWEL..2240 TOWELS PER CASE	\$ 48.84
K/C:34622	LENS CLEANING STATIONS..6 STATIONS PER CASE	\$ 59.40
K/C:05820	WHITE CENTER FLOW WIPERS..2 ROLLS / 300 SHEETS PER ROLL	\$ 86.52
K/C:05810	ECONOMIZER WIPERS..8 BOXES / 100 WIPERS PER BOX	\$ 76.80
K/C:33046	KREW 400 BLUE CENTER FLOW TOWELS..4 ROLLS / 200 SHEETS PER ROLL	\$ 61.20
K/C:33845	KREW 200 WHITE CENTER FLOW TOWELS..3 ROLLS / 550 SHEETS PER ROLL	\$ 38.88

Kimberly-Clark Medium Duty Wipers

These wipers are thicker and tougher than their light duty counterpart. They are great for shop spills and heavy duty clean-ups of grease, grime, and grit.

K/C:05796	WHITE CENTER FLOW WIPERS..2 ROLLS / 200 SHEETS PER ROLL	\$ 59.94
K/C:33036	WHITE WIPERS 1/4 FOLD..672 PER CASE	\$ 57.78
K/C:33020	KREW 400 SHOP TOWELS..12 BOXES / 85 TOWELS PER BOX	\$ 70.20
K/C:33900	TAN WIPERS..150 WIPERS PER CASE	\$ 12.87
K/C:34790	TERI WYPALLS..10 BOXES / 126 WIPERS PER BOX	\$ 85.50
K/C:05412	ALL PURPOSE WIPERS..2 ROLLS / 750' PER ROLL	\$ 33.08
K/C:05841	WYPALL WIPERS..850 WIPER ROLL	\$ 42.66
K/C:34955	X60 WYPALL WIPERS..1 ROLL / 1100'	\$ 81.24
K/C:34965	BLUE X60 WYPALL WIPERS..1 ROLL / 1100'	\$ 85.73



Other Brands

PBO:86885	9" X 15" WHITE WIPER..750' ROLL	\$ 55.50
PBO:87007	12" X 13" WHITE WIPER..800 PER CASE	\$ 47.25
PBO:88012	12" X 12" WHITE WIPER..1000 PER CASE	\$ 48.55

Kimberly Clark Heavy Duty Wipers

These wipers are very absorbent, strong, and durable. They are tough enough to wipe up metal chips and rust, and stand up to chemicals, oil, and water, yet remain soft.

K/C:33878	CENTER FLOW WHITE WIPERS..3 ROLLS / 275 SHEETS PER ROLL	\$ 66.74
K/C:41455	X70 WIPERS..10 BOXES / 100 WIPERS PER BOX	\$ 103.35
K/C:05930	X80 WIPERS..5 BOXES / 80 WIPERS PER BOX	\$ 71.33
K/C:41025	WHITE X80 WYPALL WIPERS..1 ROLL / 475'	\$ 60.93
K/C:33933	WHITE WIPERS..180 WIPERS PER CASE	\$ 25.41
K/C:33988	KREW 500 WHITE WIPERS..700 WIPERS PER CASE	\$ 111.75
K/C:75090	BLUE SHOP TOWELS..12 BOXES / 85 TOWELS PER BOX	\$ 65.88
K/C:75130	BLUE ROLL SHOP TOWELS..30 ROLLS / 55 WIPERS PER ROLL	\$ 77.41
K/C:75190	BLUE SHOP TOWELS..8 POP UP BOXES / 200 TOWELS PER BOX	\$ 109.44
K/C:41600	WORKHORSE WIPERS..870 WIPERS PER ROLL	\$ 117.95



PAPER PRODUCTS



DISPENSERS

Kimberly-Clark Dispensers

Durable and attractive!

K/C:09646	JUNIOR JUMBO TOILET TISSUE DISPENSER	\$ 29.99
K/C:09564	STEEL JUNIOR JUMBO TOILET TISSUE DISPENSER	\$ 68.63
K/C:09612	JUMBO TOILET TISSUE DISPENSER	\$ 43.52
K/C:09551	JUNIOR JUMBO TOILET TISSUE DISPENSER	\$ 44.12
K/C:09671	JUMBO TOILET TISSUE DISPENSER	\$ 15.00
K/C:09517	TOILET SEAT COVER DISPENSER	\$ 25.50
K/C:09506	TOILET SEAT COVER DISPENSER	\$ 29.04
K/C:09703	TOUCH FREE ROLL TOWEL DISPENSER	\$ 99.35
K/C:09707	LEVER MATIC ROLL TOWEL DISPENSER	\$ 122.18
K/C:09766	LEVER MATIC ROLL TOWEL DISPENSER	\$ 92.12
K/C:09746	OMNI ROLL TOWEL DISPENSER	\$ 59.12
K/C:09736	ROLL TOWEL DISPENSER	\$ 74.99
K/C:09760	ROLL TOWEL DISPENSER	\$ 57.68
K/C:09335	CENTERPULL TOWEL DISPENSER	\$ 69.70
K/C:80585	MOBILE JUMBO WIPER ROLL DISPENSER	\$ 60.23
K/C:80579	WALL MOUNT JUMBO WIPER ROLL DISPENSER	\$ 12.50
K/C:09839	SINGLE FOLD TOWEL DISPENSER	\$ 26.99
K/C:09905	C-FOLD OR MULTI-FOLD TOWEL DISPENSER	\$ 89.84
K/C:09951	STEEL C-FOLD OR MULTI-FOLD TOWEL DISPENSER	\$ 56.55
K/C:09352	POP UP BOX DISPENSER	\$ 5.99
K/C:09305	WINDSHIELD TOWEL DISPENSER	\$ 54.00



09646



09707



09746



09335

Other Brands

ABC:RR-9005	MULTIFOLD WHITE METAL DISPENSER	\$ 31.97
ABC:RR-9007	ROLL TOWEL DISPENSER	\$ 55.43
ABC:RR-9009	CENTER PULLTOWEL..DISPENSER	\$ 32.95
ABC:TCOVERSDISP	TOILET SEAT COVERS DISPENSER..1EACH	\$ 5.84

BAGS

Can Liners

A unique seam design coupled with the use of virgin plastic make these can liners extremely durable yet lightweight.

C/L:JAGL2423L	SMALL 10 GAL TRASH BAG..500 PER CASE	\$ 23.36
C/L:ESSBR2433M	CLEAR 15 GAL TRASH BAGS..1000 PER CASE	\$ 77.55
C/L:JAGL2432L	GRAY 15 GAL LIGHT WEIGHT TRASH BAGS..500 PER CASE	\$ 33.83
C/L:JAGL3036H	BLACK 20 - 30 GAL TRASH BAGS..200 PER CASE	\$ 36.70
C/L:JAGG3339G	GRAY 33 GAL TRASH BAGS..100 PER CASE	\$ 37.40
C/L:JAGL4046H	BLACK 45 GAL TRASH BAGS..100 PER CASE	\$ 30.88
C/L:JAGG4347G	GRAY 55 GAL TRASH BAGS..100 PER CASE	\$ 57.72
C/L:JAGW4347X	WHITE 55 GAL TRASH BAGS..100 PER CASE	\$ 41.20
C/L:43X48-BLK	BLACK 55 GAL 16 MICRON TRASH BAGS..200 PER CASE	\$ 26.43
C/L:43X48	CLEAR 55 GAL 16 MICRON TRASH BAGS..200 PER CASE	\$ 26.43
C/L:23X20X47ST	WHITE 55 GAL TRASH BAGS..100 PER CASE	\$ 36.40
C/L:JAGL3858H	BLACK 60 GAL TRASH BAGS..100 PER CASE	\$ 36.00
C/L:JAGG3858G	GRAY 60 GAL TRASH BAGS..100 PER CASE	\$ 55.15
C/L:JAGW3858X	WHITE 60 GAL TRASH BAGS..100 PER CASE	\$ 35.30
C/L:38X58BLKROLL	BLACK 60 GAL ROLL TRASH BAGS ..100 PER CASE	\$ 50.25
C/L:38X58-CLR	CLEAR 60 GAL 2 MIL TRASH BAGS..100 PER CASE	\$ 42.00
C/L:38X58-BLK	BLACK 60 GAL 2 MIL TRASH BAGS..100 PER CASE	\$ 59.39
C/L:38X58-WHT	WHITE 60 GAL 2 MIL TRASH BAGS..100 PER CASE	\$ 28.22
SWC:GLAD-13G	13 GAL GLAD FORCE FLEX DRAWSTRING TRASH BAG...120 PER BOX	\$ 21.78



09839
09951

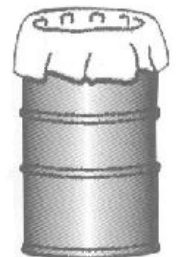

Merchandise Bags

These bags are ideal for packaging small merchandise for delivery or walk up customers.

C/L:12722	WHITE "THANK YOU" BAGS WHITE..1000 PER CASE	\$ 24.47
C/L:ICE-BAG	ICE BAGS..1000 PER CASE	\$ 46.49

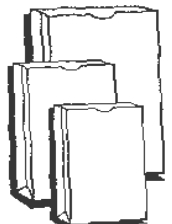

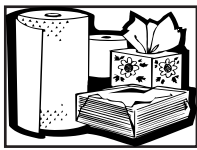

PAPER PRODUCTS

FOOD SERVICE

Cups

LAG-STOCK:6C	6 OZ COFFEE CUPS..1000 PER CASE	\$ 23.67
LAG-STOCK:8C	8 OZ COFFEE CUPS..1000 PER CASE	\$ 26.95
LAG-STOCK:10C	10 OZ COFFEE CUPS..1000 PER CASE	\$ 37.54
LAG-STOCK:12C	12 OZ COFFEE CUPS..1000 PER CASE	\$ 38.11
LAG-STOCK:16C	16 OZ COFFEE CUPS..1000 PER CASE	\$ 55.23
LAG-STOCK:20C	20 OZ COFFEE CUPS..500 PER CASE	\$ 35.52
LAG-STOCK:CONC-CUP	4.5OZ CONE CUPS..25 PACKS / 200 PER PACK	\$ 90.03



Cutlery

LAG-STOCK:FORK	PLASTIC FORKS..1000 PER CASE	\$ 10.41
LAG-STOCK:KNIFE	PLASTIC KNIVES..1000 PER CASE	\$ 15.93
LAG-STOCK:SPOON	PLASTIC SPOONS..1000 PER CASE	\$ 18.37

Coffee Supplies

LAG-STOCK:SWEET-N-LOW	SWEET'N LOW..400 PACKETS PER CASE	\$ 21.94
SWC:FOLGERS-48OZ	FOLGERS COFFEE..48OZ CANISTER	\$ 18.45
SWC:FOLGERS-DCFPKT	42 / .9OZ PACKS FOLGERS DECAF COFFEE	\$ 37.55
SWC:FOLGERS-REGPKT	42 / .9OZ PACKS FOLGERS COFFEE	\$ 27.98
SWC:CREAMER-8PK	SWC COFFEE CREAMER..8 / 12 OZ CANISTERS	\$ 13.45
SWC:SUGAR-8PK	SUGAR..8 / 22 OZ CANISTERS	\$ 12.31

MISCELLANEOUS PAPER

Kraft/Masking Paper

LAG-STOCK:KRAFT-PAPER	30" KRAFT PAPER..40 LB ROLL	\$ 37.42
-----------------------	-----------------------------	----------

Post It Notes

3M :06951	2" X 36 YARDS POST-IT REMOVABLE LABELING TAPE..1ROLL	\$ 8.10
-----------	--	---------

Vehicle Protection

PRI:SEAT-COVERS	SLIP-N-GRIP SEAT COVERS..500 PER CASE	\$ 69.08
PRI:FLOOR-MATS	ECONOMY PAPER FLOOR MATS..500 PER CASE	\$ 31.41

Paper Funnels

S/S:10BFC	PAPER FUNNELS ..1000 PER CASE	\$ 53.99
-----------	-------------------------------	----------

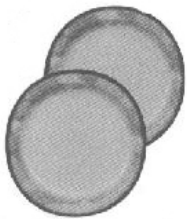

MONDAY-FRIDAY
8am-5pm a helpful
HUMAN voice will
always answer the
phone
(770)474-1286



CLEANING SUPPLIES

HEAVY DUTY HAND CLEANER

LIGHT DUTY HAND CLEANER

ANTISEPTIC HAND CLEANER

HAND WIPES

HAND CREAM

BODY WASH

SOAP DISPENSERS

CLEANERS AND DISINFECTANTS

MULTI-PURPOSE CLEANERS

FURNITURE POLISH

GLASS CLEANERS

ODOR CONTROL

BOWL CLEANERS

FLOOR PRODUCTS

SPECIALTY CLEANERS

BROOMS

DUST PANS

RAGS

MOPPING EQUIPMENT

DUST MOPS

SQUEEGEES

BRUSHES

HANDLES

SPRAY BOTTLES

PARKER, BROTHERS, INC.



4450 WEST PANOLA RD
ELLENWOOD, GA

CLEANING SUPPLIES



HEAVY-DUTY HAND CLEANER

Kimberly-Clark Sani-Tuff Hand Cleaner

Specially formulated to clean the toughest dirt, including grease and tar. It contains no harsh solvents and even helps condition rough, dry hands with aloe vera.

K/C:91263	SUPER DUTY HAND CLEANER WITH GRIT..24 / 8 OZ BOTTLES	\$ 46.80
K/C:91270	SUPER DUTY HAND CLEANER..12 / 800 ML PACKS	\$ 55.80
K/C:91757	SUPER DUTY HAND CLEANER WITH GRIT..2 / 3.5 LITER BOXES	\$ 63.09
K/C:91748	SUPER DUTY HAND CLEANER WITH GRIT..2 / 8 LITER BOXES	\$ 110.85

GoJo Hand Cleaner

GoJo makes an extensive line of products. Parker Brothers is proud to feature many of them.

G/J:0905	LEM ON HAND CLEANER ..4 1/2 LB CAN	\$ 20.60
G/J:0915	LEM ON HAND CLEANER WITH PUMICE..4 1/2 LB CAN	\$ 23.22
G/J:0955	ORANGE HAND CLEANER WITH PUMICE ..1 GAL	\$ 13.71
G/J:0957-12	ORANGE HAND CLEANER WITH PUMICE..12 / 14OZ BOTTLES	\$ 45.44
G/J:0965-C	ORANGE HAND CLEANER..6 / 4 1/2LB CANS	\$ 116.16
G/J:1109	ORIGINAL FORMULA HAND CLEANER..18 OZ CAN	\$ 3.08
G/J:1111	ORIGINAL FORMULA HAND CLEANER..4 1/2 LB CAN	\$ 18.83
G/J:1115	ORIGINAL FORMULA HAND CLEANER..4 1/2 LB CAN	\$ 11.99
G/J:1135	PUMICE HAND CLEANER..4 1/2 LB CAN	\$ 14.99
G/J:1206	INTRO PACK - 1115 HAND CLEANER / 1204 DISPENSER..1 SET	\$ 39.91
G/J:7250-04	ORANGE HAND CLEANER..4 / 2000 ML BOXES	\$ 70.78
G/J:7255-04	ORANGE HAND CLEANER WITH PUMICE..4 / 2000 ML BOXES	\$ 89.59
G/J:7272-04	SUPRO 2000 HAND CLEANER..4 / 2000 ML BOXES	\$ 111.55
G/J:7295-04	POWER GOLD HAND CLEANER..4/ 2000 ML BOXES	\$ 109.43
G/J:0988	POWER GOLD HAND CLEANER..2 LITER PUMP BOTTLE	\$ 18.43
G/J:7296-02	POWER GOLD HAND CLEANER..1 GAL	\$ 18.09
G/J:7596	POWER GOLD HAND CLEANER..2/5000M L	\$ 118.50



Knight Poly Scrub Hand Cleaner

Poly scrub removes petroleum based soils, inks, stains, glues, paints, and other tough soils fast. It's antiseptic and economical.

SPR:13104	POLY SCRUB ANTISEPTIC HAND SOAP..4 LB TUB	\$ 16.33
SPR:14104	COCO SCRUB ANTISEPTIC HAND SOAP..4 LB TUB	\$ 15.24

Other Brands

KIMBERLY-CLARK

K/C:91700	NATURALLY TOUGH ORANGE HAND CLEANER..4 / 1 GAL	\$ 58.80
K/C:91032	NATURALLY TOUGH ORANGE HAND CLEANER..12 / 14OZ BOTTLES	\$ 30.45
K/C:91035	NATURALLY TOUGH ORANGE HAND CLEANER WITH GRIT..2 / 1 GAL	\$ 26.33
K/C:91754	WATERLESS HAND CLEANER..2 / 3.5 LITER BOXES	\$ 44.25
K/C:91755	WATERLESS HAND CLEANER WITH GRIT..2 / 3.5 LITER BOXES	\$ 47.25
K/C:91213	WATERLESS HAND CLEANER WITH GRIT..2 / 3.5 LITER BOXES	\$ 44.10



PERMATEX

PER:23116	FAST ORANGE HAND CLEANER..15 OZ	\$ 3.18
PER:33013	FAST ORANGE HAND CLEANER..14 OZ TUB	\$ 2.47
PER:23218	FAST ORANGE HAND CLEANER..1 GAL	\$ 13.31
PER:25218	FAST ORANGE PUMICE HAND CLEANER..1 GAL WITH BRUSH	\$ 11.99
PER:27218	FAST ORANGE DRY SKIN HAND CLEANER..1 GAL	\$ 19.07
PER:99008	FAST ORANGE HAND CLEANER..2 - 1 GAL	\$ 21.99
PER:21218	TROUNCE PUMICE LOTION HAND CLEANER..1 GAL	\$ 16.50
PER:01406	BLUE LABEL CREAM HAND CLEANER..4.5 LB CAN	\$ 8.59
PER:35406	FAST ORANGE PUMICE HAND CLEANER..4.5 LB CAN	\$ 8.99

ABC

ABC:M 80-1G	M 80 CHERRY HAND SOAP..1 GAL	\$ 18.32
ABC:STOUT-1G	STOUT HAND CLEANER ..1 GAL	\$ 18.35
ABC:FOAMY MANGO-C	FOAMY MANGO ANTIBACTERIAL SOAP...8 / 1000ML CARTRIDGES	\$ 65.71



PARKER, BROTHERS, INC.



CLEANING SUPPLIES

LIGHT-DUTY HAND CLEANER

Kimberly-Clark Sani-Fresh Hand Cleaner

Formulated as a lotion cleanser to remove light soils. It's neutral pH formula has a rich, creamy lather and a pleasant floral fragrance

K/C:91211	PINK LOTION HAND SOAP..12 / 800 ML PACKS	\$ 61.20
K/C:92053	GENTLE LOTION HAND SOAP..18 / 500 ML PACKS	\$ 98.25

Other Brands

GO-JO

G/J:7220-04	PINK ANTIBACTERIAL HAND SOAP..4 / 2000 ML BOXES	\$ 56.50
G/J:9112-12	DERMAPRO LOTION HAND CLEANER..12 / 800 ML BOXES	\$ 57.57
G/J:2015	DERMALITE HAND CLEANER..6 / 1 GAL	\$ 98.50

ABC

ABC:RR-L900	PINK LOTION SOAP..1 GAL	\$ 6.02
ABC:RR-L900-800ML	PINK LOTION SOAP..800 ML	\$ 27.83

ANTISEPTIC HAND CLEANER

Kimberly-Clark Antiseptic Skin Cleanser

An antimicrobial soap that gently cleanses. It's all-synthetic blend works to reduce the risk of cross-contamination.

K/C:91248	ANTISEPTIC HAND CLEANER..12 / 800 ML PACKS	\$ 63.90
-----------	--	----------

GoJo Antibacterial Soap And Hand Sanitizer

G/J:5962-12	LUXURY ANTIBACTERIAL FOAM SOAP..12 / 6.7 OZ BOTTLES	\$ 52.29
G/J:9651	PURELL HAND SANITIZER..24 / 4 OZ BOTTLES	\$ 49.50

Other Brands

LAG-STOCK:DIA84014	ANTIMICROBIAL DAIL SOAP..12 / 7.5 OZ PUMP BOTTLES	\$ 36.53
LAG-STOCK:DIA88047	ANTIMICROBIAL DIAL SOAP..4 / 1 GAL	\$ 49.99

HAND WIPES

Kimberly-Clark Hand Wipes

One-step heavy-duty hand cleaning towels. Large, absorbent, non-woven towels are pre-moistened with orange formula and quickly remove grease and dirt right on the spot.

K/C:91371	WATERLESS HAND WIPES..6 BUCKETS / 75 WIPES PER BUCKET	\$ 72.99
-----------	---	----------

GoJo Hand Wipes

G/J:6398	FAST WIPES..170 PER BUCKET..1 BUCKET	\$ 30.92
G/J:6299	FAST WIPES..225 PER BUCKET..1 BUCKET	\$ 36.15



CALL PARKER BROTHERS
MONDAY - FRIDAY 8AM - 5PM
WE'LL BE GLAD TO HELP!

CLEANING SUPPLIES



SOAP DISPENSERS

Kimberly-Clark Dispensers

K/C:91180	800 MILLILITER SOAP DISPENSER..1 EACH	\$ 18.51
K/C:91011	800 MILLIMETER SOAP DISPENSER	\$ 14.70
K/C:92013	SOAP DISPENSER 3.5 OR 8 LITER	\$ 19.54

GoJo Dispensers

G/J:1204	4 1/2 LB CAN BLACK DISPENSER..1 EACH	\$ 21.99
G/J:9033	DERMA DISPENSER..1 EACH	\$ 19.06
G/J:9034	800 ML BLACK DISPENSER..1 EACH	\$ 22.61
G/J:7200	2000 ML BLACK DISPENSER..1 EACH	\$ 17.14

Poly-Scrub Dispenser

SPR:71500	POLY SCRUB DISPENSER..1 EACH	\$ 34.70
-----------	------------------------------	----------

ABC Dispenser

ABC:218500	HAND SOAP DISPENSER..1 EACH	\$ 54.58
ABC:218501	HAND SOAP DISPENSER..1 EACH	\$ 98.96
ABC:218519	FOAM HAND SOAP DISPENSER	\$ 15.02
ABC:218542	1000 ML BAG FOAMY HAND SOAP DISPENSER	\$ 16.05

Permatex Dispensers

PER:95140	UNIVERSAL HAND CLEANER DISPENSER..1 EACH	\$ 22.55
PER:90128	WALL MOUNT WIRE BRACKET FOR HAND CLEANER..1 EACH	\$ 19.97

Lagasse Dispensers

LAG-STOCK:UNS417	LAG-STOCK ECONO PUMP DISPENSER..FOR GAL. LIQ. SOAP/SOLVENT	\$ 3.31
------------------	--	---------

CLEANERS AND DISINFECTANTS

Spray-Nine

Spray-nine was America's first "spray on-wipe off" germicidal cleaner. It is formulated to tackle the toughest grime and kill germs in record time.(WOW!! 45 seconds)

SPR:26832	MULTI-PURPOSE CLEANER & DISINFECTANT..32 OZ PUMP BOTTLE	\$ 5.16
SPR:SPRAY-NINE-G	MULTI-PURPOSE CLEANER & DISINFECTANT..1 GAL	\$ 13.17
SPR:SPRAY-NINE-P	MULTI-PURPOSE CLEANER & DISINFECTANT..5 GAL	\$ 64.95
SPR:SPRAY-NINE-D	MULTI-PURPOSE CLEANER & DISINFECTANT..55 GAL	\$ 460.45

Other Brands

CLN:BLEACH-1G	BLEACH..1 GAL	\$ 2.22
LAG-STOCK:LYSOL-E	LYSOL DISINFECTANT..19 OZ AEROSOL	\$ 4.83
LAG-STOCK:CLO35418	PINE SOL ..3 / 144 OZ BOTTLES.	\$ 35.24

MULTI-PURPOSE CLEANERS

Parker Brothers Cleaner

Packaged by Spray Nine , this product contains the same fast acting grease and grime fighting formula as Spray-Nine. Parker Brothers Cleaner gives you a more economical choice when disinfecting is not an issue.

PBI:M 93201	MULTI-PURPOSE CLEANER..1 GAL	\$ 10.06
PBI:M 93232	MULTI-PURPOSE CLEANER..32 OZ	\$ 4.05
PBI:M 93255	MULTI-PURPOSE CLEANER..55 GAL	\$ 485.68

Other Brands

LAG-STOCK:CLO35604	TILEX SOAP SCUM REMOVER..9 / 32 OZ BOTTLES	\$ 49.54
LAG-STOCK:CLO35600	TILEX MILDEW REMOVER..9 / 32 OZ BOTTLES	\$ 49.45
CLN:AMMONIA-1G	AMMONIA..1 GAL	\$ 9.38
CLN:AMMONIA-D	AMMONIA..55 GAL	\$ 227.34

FURNITURE POLISH

Dusting Products

LAG-STOCK:PLEDGE	PLEDGE FURNITURE POLISH..12.5 OZ AEROSOL	\$ 6.50
CRC:05185	DUST REMOVAL SYSTEM ..10 OZ AEROSOL	\$ 5.57

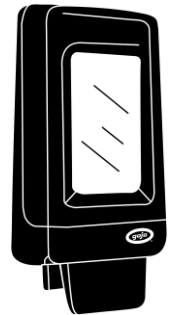



CLEANING SUPPLIES

GLASS CLEANER

Glass Plus

A light duty cleaner for cleaning glass, mirrors, and other hard surfaces.

LAG-STOCK:GLASSPLUS-QT	GLASS PLUS..1 QT	\$ 18.42
LAG-STOCK:GLASSPLUS-1G	GLASS PLUS..1 GAL	\$ 29.75

Other Brands

3M :08888	GLASS CLEANER ..19 OZ. AEROSOL CAN	\$ 3.24
PER :29450	SIMONIZ GLASS CLEANER ..18 OZ AEROSOL	\$ 2.17
PER :25544	FAST ORANGE GLASS CLEANER ..20 OZ AEROSOL	\$ 3.30
SSG:GC-1	FOAMY GLASS CLEANER ..19 OZ AEROSOL	\$ 2.64



ODOR CONTROL

Time Mist Air Freshener

When used with the Time Mist Dispenser, each can is a full 30 days supply of fresh clean fragrances. For use anywhere odor is a problem. The battery operated dispenser is set to freshen the air every 15 minutes 24 hours a day. (Batteries not included) Two D cell batteries will last 2 years.

LAG-STOCK:TMS2404	MICRO TIME MIST COUNTRY GARDEN AIR FRESHENER..12 PER CASE	\$ 87.45
LAG-STOCK:TMS2460	MICRO TIME MIST MANGO AIR FRESHENER..12 PER CASE	\$ 66.02
LAG-STOCK:TMS2509	TIME MIST HERBAL MIST AIR FRESHENER..30 DAY CAN	\$ 6.19
LAG-STOCK:TMS2512	TIME MIST BABY POWDER AIR FRESHENER..30 DAY CAN	\$ 4.61
LAG-STOCK:TMS2513	TIME MIST PINA COLADA AIR FRESHENER..30 DAY CAN	\$ 4.68
LAG-STOCK:TMS2516	TIME MIST GREEN APPLE AIR FRESHENER..30 DAY CAN	\$ 6.38
LAG-STOCK:TMS2517	TIME MIST CHERRY AIR FRESHENER..30 DAY CAN	\$ 4.61
LAG-STOCK:TMS2522	TIME MIST COUNTRY GARDEN AIR FRESHENER..30 DAY CAN	\$ 5.15
LAG-STOCK:TMS2553	TIME MIST SPRING FLOWERS AIR FRESHENER..30 DAY CAN	\$ 4.53
LAG-STOCK:TMS2965	TIME MIST VOODOO BERRY AIR FRESHENER..30 DAY CAN	\$ 4.93

Time Mist Dispensers

LAG-STOCK:TMS1111TM	GRAY TIME MIST DISPENSER..1 EACH	\$ 34.65
LAG-STOCK:TMS1131TM	BEIGE TIME MIST DISPENSER..1 EACH	\$ 34.02

Spray Nine Air Fresheners

These powerful products are designed to first mask odors with a light scent, then leave the area with a nice neutral smell.

SPR:23001	ODOR ELIMINATOR ..1 GAL	\$ 16.83
SPR:23032	ODOR ELIMINATOR ..32 OZ PUMP BOTTLE	\$ 5.50
SPR:23732	SUN BREEZE AIR FRESHENER ..32 OZ PUMP BOTTLE	\$ 5.51

Other Brands

ABC:LON-GONE-QT	BAN AIRE LON GONE..32 OZ	\$ 5.95
ABC:LON-GONE-1G	BAN AIRE LON GONE..1 GAL	\$ 19.62
ABC:CHERRY-DEOD-1G	CHERRY DEODORANT CONCENTRATE..1 GAL	\$ 9.25
CLN:PEACH-EA	PEACH DEODORIZER..32 OZ PUMP BOTTLE	\$ 5.27
CLN:CHERRY-EA	CHERRY DEODORIZER..32 OZ PUMP BOTTLE	\$ 4.99
CLN:Q-MELON-G	Q-MELON DEODORANT..1 GAL	\$ 10.38
LAG-STOCK:FRS1216HUCHRY	BERRY SCENTED DEODORANT CUPS..12 PER CASE	\$ 35.72
LAG-STOCK:FRS-6-16HU-CH	16OZ CHERRY WALL BLOCKS..6 PER BOX	\$ 6.64
LAG-STOCK:FRS12-4G-CH	4.6 OZ RE-FRESH GEL AIR FRESHENER..12 PER CASE	\$ 19.50

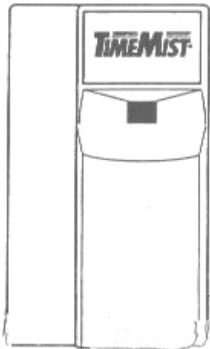

Parker Brothers
gladly accepts
Visa, Mastercard
Discover &
American Express

CLEANING SUPPLIES



BOWL CLEANERS

Bowl/Urinal Products

Parker Brothers carries a wide assortment of products for keeping your restrooms sanitary and odor free.

LAG-STOCK:BGD661	4 OZ HANGING TOILET DEODORANTS..12 PER BOX	\$ 24.87
LAG-STOCK:DRK90157	VANISH DISINFECTANT BOWL CLEANER..32 OZ BOTTLE	\$ 8.73
LAG-STOCK:FRS12-4-CH	4 OZ URINAL BLOCK..12 PER CASE	\$ 23.26
LAG-STOCK:FRS12-BBL	9 OZ BIG BLUE AUTOMATIC BOWL CLEANER..12 PER CASE	\$ 28.88
LAG-STOCK:FRS12-USPB	URINAL SCREENS WITH 4 OZ DEODORANT BLOCK..12 PER BOX	\$ 14.29
LAG-STOCK:FRS12DS-CH	CHERRY URINAL SCREENS..12 PER BOX	\$ 25.54
LAG-STOCK:TY-D-BOWL	TY-D-BOWL AUTOMATIC BOWL CLEANER..12 / 12 OZ BOTTLES	\$ 15.55



FRS-12-4-CH

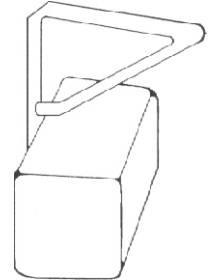

BGD661

FLOOR PRODUCTS

ABC Hound Dog Powdered Concrete Cleaner

A highly efficient concrete cleaner compounded with detergents and solvents for handling heavy duty jobs and for the everyday removal of dirt and grease from concrete surfaces.

ABC:HOUNDDOG-50LB	HOUND DOG POWDER CONCRETE CLEANER..50 LB DRUM	\$ 79.53
ABC:HOUNDDOG-100LB	HOUND DOG POWDER CONCRETE CLEANER..100 LB DRUM	\$ 112.41

CLN Degreaser

A highly economical, multi-purpose product. Dollar for dollar, the best degreaser on the market. It cleans up engines, floors, and everything else. Plus, it is a great wax stripper.

CLN:DEGREASER-P	HOT OR COLD DEGREASER..6 GAL	\$ 45.77
CLN:DEGREASER-D	HOT OR COLD DEGREASER..55 GAL	\$ 263.25

Other Brands

LAG-STOCK:SMP 13005	SIMPLE GREEN..6 / 1 GAL	\$ 84.99
SPR:27901	EARTH SOAP DEGREASER ..1 GAL	\$ 13.49

Neutra-Mop

This economical solution cleans most hard household and show room floors.

ABC:NEUTRA-CLEAN-1G	NEUTRAL CLEANER..1 GAL..	\$ 10.96
---------------------	--------------------------	----------

CLN Acid Concrete Cleaner

CLN:REDOX-D	ACID CONCRETE CLEANER..55 GAL	\$ 293.88
CLN:REDOX-P	ACID CONCRETE CLEANER..6 GAL	\$ 46.87

Sweeping Compound

NEW:OIL-BASE-100	OIL BASE SWEEPING COMPOUND WITH GRIT..100 LB	\$ 30.77
NEW:OIL-BASE-300	OIL BASE SWEEPING COMPOUND WITH GRIT..300 LB	\$ 93.58
NEW:WAX-BASE-100	WAX BASE SWEEPING COMPOUND..100LB	\$ 59.99
NEW:WAX-BASE-150	GREEN FLUFFY WAX BASE SWEEPING COMPOUND ..150LB	\$ 79.41

ABC Floor Wax

This floor finish dries to a very bright gloss and maintains easily with spray buffing. Even when completely dry, your floor will have a deep, even shine that resembles the appearance of a wet surface.

ABC:FLOORWAX-1GAL	CLASSIC RESILIENT FLOOR WAX..1 GAL	\$ 13.05
ABC:FLOORWAX-P	CLASSIC RESILIENT FLOOR WAX..5 GAL	\$ 79.89
ABC:FLOORWAX-D	CLASSIC RESILIENT FLOOR WAX..55 GAL	\$ 64.18

ABC Wax Stripper

This is an ammoniated, soap-based wax remover ideal for the stripping and removal of waxes and polymer floor finishes.

ABC:WAX-STRIPPER-1G	ZAP-O WAX STRIPPER AND DEGREASER..1 GAL	\$ 8.69
ABC:WAX-STRIPPER-P	ZAP-O WAX STRIPPER AND DEGREASER..5 GAL	\$ 41.52

ABC Carpet Cleaning

This carpet cleaner is formulated to remove grease, oil, and soils from older and easily soiled carpets

ABC:CARPET-CLNR-1G	FIBRE ZONE CARPET SHAMPOO..1 GAL	\$ 13.81
--------------------	----------------------------------	----------

SPECIALTY CLEANERS

Stainless Steel Cleaner

LAG-STOCK:SHEILA-SHINE	STAINLESS STEEL CLEANER..12 OZ AEROSOL	\$ 8.46
------------------------	--	---------

Screen Cleaner

SPR:52308	LCD / PLASMA SCREEN CLEANER..8 OZ PUMP BOTTLE	\$ 4.99
-----------	---	---------



FRS12-BBLS-F

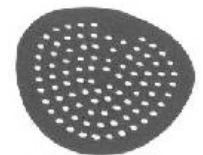

FRS12DS-CH

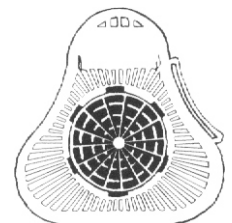

FRS12-USPB





CLEANING SUPPLIES

BROOMS

Parker Brothers Push Brooms

These fine brooms are made with hardwood blocks and come complete with head, metal tip handle and stabilizing brace. The black brooms have 3in Tampico bristles for fine and medium sweeping. The green brooms have 3in plastic bristles for moving heavy piles and scrubbing



PBO B1-24

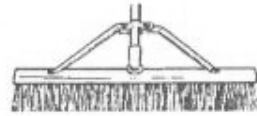

PBO G1-24

PBO:B1-18	18" COMPLETE PUSH BROOM..HEAD - HANDLE - BRACE..1 EACH	\$ 17.39
PBO:B1-24	24" COMPLETE PUSH BROOM..HEAD - HANDLE - BRACE..1 EACH	\$ 18.50
PBO:S1-24-SOFT	24" COMPLETE PUSH BROOM..HEAD - HANDLE - BRACE..1 EACH	\$ 22.99
PBO:B1-36	36" COMPLETE PUSH BROOM..HEAD - HANDLE - BRACE..1 EACH	\$ 24.75
PBO:S1-36-SOFT	36" COMPLETE PUSH BROOM..HEAD - HANDLE - BRACE..1 EACH	\$ 36.00
PBO:M1-24	24" COMPLETE SCRUBBING BROOM..HEAD - HANDLE - BRACE..1 EACH	\$ 18.50
PBO:S1-24-COARSE	24" COMPLETE SCRUBBING BROOM..HEAD - HANDLE - BRACE..1 EACH	\$ 22.99
PBO:S1-36-COARSE	36" COMPLETE SCRUBBING BROOM..HEAD - HANDLE - BRACE..1 EACH	\$ 36.00

Push Brooms

Bru 100224 is a 24in hardwood block filled with 3in black Tampico bristles. It is for fine to medium sweeping.

BRU:100224	24" BLACK PUSH BROOM HEAD..1 EACH	\$ 14.68
------------	-----------------------------------	----------

Household Style Brooms

Lag-stock Stick-broom is made of high quality broom corn. The handle is 1.12in in diameter. It is economical and long lasting

LAG-STOCK:STICK-BROOM	CORN BROOM ..1 EACH	\$ 7.32
-----------------------	---------------------	---------



Bru 854

Bru 854 is two brooms in one. It has two holes; one upright for regular sweeping and the other angled for sweeping along baseboards and in corners.

BRU:854	DUO-SWEEP BROOM ..1 EACH	\$ 6.25
---------	--------------------------	---------

Bru 81 has a 24in handle and 10in corn bristles. It is perfect for use with a lobby dust pan in parking lots or lobbies

BRU:81	BABY BROOM ..1 EACH	\$ 3.91
--------	---------------------	---------

Bru 860 has 2 threaded handle holes, one angled, and one upright. The black stiff filament sweeps heavier debris.

BRU:860	DUO-SWEEP LOBBY BROOM ..1 EACH	\$ 3.99
---------	--------------------------------	---------

Lag-stock 932a is an angled broom for making quick work of light sweeping jobs.

LAG-STOCK:932A	LARGE ANGLER BROOM ..1 EACH	\$ 10.01
----------------	-----------------------------	----------



Stick-Broom

Plastic Bristle Brooms

These brooms are designed for moving heavy piles or scrubbing. They all are tough and long wearing.

Bru 130216 is a 16in hardwood block filled with 5.12in Polybass bristles.

BRU:130216	16" POLY STREET BROOM ..1 EACH	\$ 13.79
------------	--------------------------------	----------



Bru 130216

DUST PANS

Steel Dust Pans

BRU:236	12" STEEL DUSTPAN..1 EACH	\$ 7.40
BRU:237	16" STEEL DUST PAN..1 EACH	\$ 13.96

Plastic Dust Pans

BRU:1437	12" BLACK PLASTIC DUST PAN..1 EACH	\$ 3.55
----------	------------------------------------	---------

Lobby Dust Pans

BRU:410112	LOBBY DUST PAN..1 EACH	\$ 14.34
------------	------------------------	----------

Lobby Dust Pan/Baby Broom Combo

BRU:410212	LOBBY DUST PAN / BABY BROOM COMBO..1 EACH	\$ 21.40
------------	---	----------



BRU 410112

RAGS, PADS, AND SPONGES

Micro Fiber Cloths

BRU:380116B	16" X 16 " BLUE MICRO FIBER CLOTH	\$ 1.50
BRU:380116G	16" X 16 " GREEN MICRO FIBER CLOTH	\$ 1.50
BRU:380116R	16" X 16 " RED MICRO FIBER CLOTH	\$ 1.50
BRU:380116Y	16" X 16 " YELLOW MICRO FIBER CLOTH	\$ 1.50

CLEANING SUPPLIES



RAGS, PADS, AND SPONGES

Clothes Rags

RAG:8383-50	15" X 15" COTTON SHOP RAGS..50 PER BAG	\$ 22.49
RAG:8383	15" X 15" COTTON SHOP RAGS..100 PER BAG	\$ 25.29
RAG:TERRY-TOWEL-48	TERRY CLOTH RAGS ..48 PER PACK	\$ 19.99
RAG:TERRY-60PK	TERRY CLOTH RAGS ..60 PER PACK	\$ 30.66
RAG:TERRY-CLOTH	TERRY CLOTH & TURKISH TOWELS..50 LB BOX	\$ 66.00
RAG:WHITE-WIPERS	COTTON WIPERS..50 LB BOX	\$ 74.14
RAG:WHITE-KNIT	T-SHIRT RAGS..50 LB BOX	\$ 82.23
RAG:COLOR-WIPERS	ASST COLOR WIPERS..50 LB BOX	\$ 60.23
RAG:MIXED-FLEECE	COLOR AND WHITE FLEECE RAGS..50 LB BOX	\$ 50.28
RAG:MICRO-30PK	MICRO-FIBER RAGS..30 PER BAG	\$ 22.47

Sponges

LAG-STOCK:CS2	MEDIUM SPONGE..1EACH	\$ 1.36
LAG-STOCK:CS3	LARGE SPONGE..1EACH	\$ 2.35

Buffing Pads

LAG-STOCK:PAD4020BLA	20" BLACK FLOOR STRIPPING ..5 PER BOX	\$ 32.95
----------------------	---------------------------------------	----------

MOPPING EQUIPMENT

Cotton Mop Heads

Economical, long lasting, heavy duty mop heads for general mopping jobs. They are available in two sizes, 24oz and 32oz, and two styles, clamp-on and screw-on.

LAG-STOCK:MOP-HEAD-24	24 OZ CLAMP ON COTTON MOP HEAD..1EACH	\$ 4.32
LAG-STOCK:MOP-HEAD-32	32 OZ CLAMP ON COTTON MOP HEAD..1EACH	\$ 6.93

One Piece Mop

LAG-STOCK:REG-MOP	24 OZ COTTON MOP..1EACH	\$ 9.39
-------------------	-------------------------	---------

Mop Handles

Bru 93w is a wing-nut style clamp-on mop handle. The metal head is double-riveted for extra strength.

BRU:93W	CLAMP ON MOP HANDLE..1EACH	\$ 8.85
---------	----------------------------	---------

Lag-stock 84 is a fiberglass clamp-on style handle with one corner hinged for quick mop head replacement.

LAG-STOCK:84	FIBERGLASS QUICK CHANGE MOP HANDLE..1EACH	\$ 13.80
--------------	---	----------

Mop Bucket

Made of heavy duty plastic, this bucket /wringer combo is designed for years of trouble free service.

LAG-STOCK:RCP7580-88YEL	35 QT. MOP BUCKET/SIDE WRINGER COMBO	\$ 93.82
-------------------------	--------------------------------------	----------

DUST MOPS

Dust Mop Frames and Heads

Heavy gauge rod frame and long fiber cotton yarn allows pick up and holding of large amounts of dirt and dust. The head is launderable, and the frames are rust resistant.

BRU:UNS1236	3" X 36" DUST MOP FRAME..1EACH	\$ 5.50
BRU:UNS1036	3" X 36" DUST MOP HEAD..1EACH	\$ 10.60
BRU:UNS1424	5" X 24" DUST MOP FRAME..1EACH	\$ 4.40
BRU:UNS1324	5" X 24" DUST MOP HEAD..1EACH	\$ 11.19
BRU:UNS1436	5" X 36" DUST MOP FRAME..1EACH	\$ 6.40
BRU:UNS1636	5" X 36" DUST MOP HEAD..1EACH	\$ 10.73
BRU:UNS1248	3" X 48" DUST MOP FRAME..1EACH	\$ 5.20
BRU:UNS1448	5" X 48" DUST MOP FRAME..1EACH	\$ 7.06
BRU:48X5DMS	5" X 48" DUST MOP HEAD..1EACH	\$ 12.34
LAG-STOCK:UNS1348	5" X 48" DUST MOP HEAD..1EACH	\$ 18.08

Dust Mop Handle

BRU:2015	5' CLIP ON DUST MOP HANDLE..1EACH	\$ 10.65
----------	-----------------------------------	----------

Parker Brothers
gladly accepts
Visa, Mastercard
Discover &
American Express

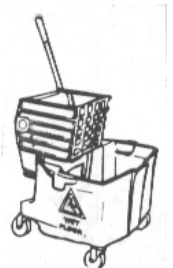

ABC RR_COMBO

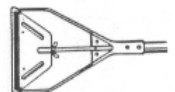

Bru 93w

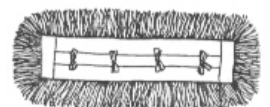



CLEANING SUPPLIES

SQUEEGEES

Window Squeegees

These squeegees make quick work of windows. The brass frame and precision cut rubber blade are designed for long life.

BRU:280-18	18" WINDOW SQUEEGEE..1 EACH	\$ 11.69
BRU:284-12	12" WINDOW SQUEEGEE..1 EACH	\$ 10.11
BRU:284-16	16" WINDOW SQUEEGEE..1 EACH	\$ 11.11
BRU:284-18	18" WINDOW SQUEEGEE..1 EACH	\$ 16.85
BRU:284H	WINDOW SQUEEGEE HANDLE..1 EACH	\$ 5.23
BRU:284CR-18	18" WINDOW SQUEEGEE REFILL..1 EACH	\$ 6.42

Floor Squeegees

Bru 40 Series and 61 Series are aluminum frames with gray, vinyl, non-marking blades. They are durable and long lasting

BRU:4024C	24" VINYL CURVED END FLOOR SQUEEGEE..1 EACH	\$ 22.98
BRU:4030C	30" VINYL CURVED END FLOOR SQUEEGEE..1 EACH	\$ 25.72
BRU:4036C	36" VINYL CURVED END FLOOR SQUEEGEE..1 EACH	\$ 29.03
BRU:270324	24" VINYL STRAIGHT FLOOR SQUEEGEE..1 EACH	\$ 18.75
BRU:6124R	24" VINYL STRAIGHT FLOOR SQUEEGEE REFILL..1 EACH	\$ 3.90
BRU:270336	30" VINYL STRAIGHT FLOOR SQUEEGEE..1 EACH	\$ 27.52
BRU:6136	36" VINYL STRAIGHT FLOOR SQUEEGEE..1 EACH	\$ 25.35

Bru 63 Series has a steel frame and a black foam blade. They are very absorbent and do not chatter.

BRU:6318	18" FOAM FLOOR SQUEEGEE..1 EACH	\$ 5.03
BRU:270530	30" REINFORCE FOAM FLOOR SQUEEGEE..1 EACH	\$ 14.65

BRUSHES

Floor Brushes

Bru 230710 is a 10in plastic block with a threaded hole, 2in crimped plastic bristles and a squeegee. It serves the dual purpose of scrubbing and removing water. (Handle not included)

BRU:230710	10" DUAL SURFACE SCRUBBING BRUSH WITH SQUEEGEE..1 EACH	\$ 10.69
------------	--	----------

Bru 230110 is a 10in hardwood block with a threaded hole, a tapered hole, and 2in Tampico fibers. It is for scrubbing, etching, or acid cleaning. (Handle not included)

BRU:230110	10" WHITE SCRUBBING BRUSH..1 EACH..193	\$ 6.16
------------	--	---------

Bru 5300 made with a special u joint design, this scrubber is ideal for multi-level floors. It is a plastic block filled with Dupont Tynex fiber for cleaning tile and grout. (Handle not included)

BRU:5300	GENERAL SWIVEL SCRUBBER..1 EACH	\$ 31.24
----------	---------------------------------	----------

Hand Brushes

Bru 277 made in a 9in pointed hardwood block filled with 1.12in white tampico bristles.

BRU:277	9" WHITE SCRUBBING BRUSH..1 EACH	\$ 3.56
---------	----------------------------------	---------

Bru 540210 1.12in wide steel bristle brush with a metal scraper.

BRU:540210	STEEL WIRE BRUSH WITH SCRAPER..1 EACH	\$ 3.20
------------	---------------------------------------	---------

Bru 239 Get your hands super clean. This nail brush will remove the worst grime from the smallest places.

BRU:239	NAIL OR HAND BRUSH..1 EACH..	\$ 2.99
---------	------------------------------	---------

Bru P5 brush

BRU:P5	TOILET BOWL BRUSH..1 EACH	\$ 0.84
--------	---------------------------	---------

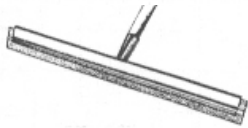
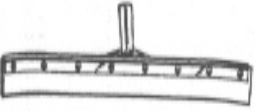

Bru 230710



Bru 230110



Bru 5300



Bru 84



Bru 277



Bru 540210



Bru 239



Bru P5

CLEANING SUPPLIES



HANDLES

Threaded Handles

BRU:140160	5' WOOD THREADED WOOD HANDLE..1EACH	\$ 4.29
BRU:140460	5' METAL THREADED WOOD HANDLE..1EACH	\$ 4.78
BRU:140860	5' FIBERGLASS THREADED HANDLE..1EACH	\$ 7.77
BRU:140596	8' METAL THREADED WOOD HANDLE..1EACH	\$ 12.64
BRU:RIDGID	RIDGID BRACE..1EACH	\$ 3.00
BRU:140630	2.5' PLASTIC THREADED HANDLE..1EACH	\$ 1.32
BRU:140360	5' TAPERED HANDLE..1EACH	\$ 7.71

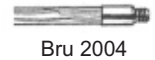
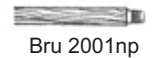

Mop Handles

LAG-STOCK:84	FIBERGLASS QUICK CHANGE MOP HANDLE..1EACH	\$ 13.80
BRU:2015	5' CLIP ON DUST MOP HANDLE..1EACH	\$ 10.65



Other Handles

BRU:140260	5' TAPERED SQUEEGEE HANDLE..1EACH	\$ 2.42
BRU:466FH	5' FLOW THROUGH HANDLE..1EACH	\$ 8.87

SPRAY BOTTLES

Bottles

LAG-STOCK:BOTTLE	CHEMICAL BOTTLE AND SPRAYER..1EACH	\$ 1.30
LAG-STOCK:SPRAYER	SPRAYER ONLY..1EACH	\$ 0.88

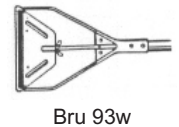

PARKER, BROTHERS, INC.
 PARKER, BROTHERS, INC.
 PARKER, BROTHERS, INC.
 PARKER, BROTHERS, INC.
 PARKER, BROTHERS, INC.
 PARKER, BROTHERS, INC.
 PARKER, BROTHERS, INC.

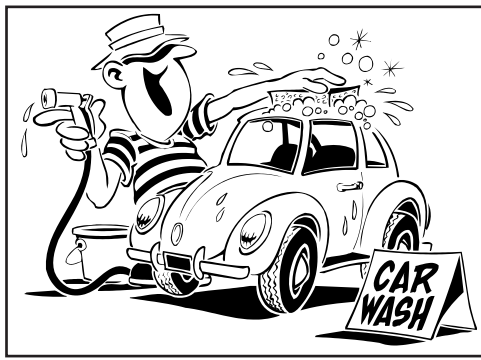

AUTO DETAIL SUPPLIES

SOAP
MULTI-PURPOSE CLEANER
DEGREASER
TIRE CLEANER
WHEEL CLEANER
SPECIALTY CLEANER
WINDSHIELD TREATMENTS
AIR FRESHENERS
TIRE AND VINYL DRESSING
WAX
POLISH
RUBBING COMPOUNDS/BUFFING PADS
WATER HOSES AND NOZZLES
BUCKETS AND CHAMOIS
BRUSHES
HANDLES

AUTO DETAIL SUPPLIES



SOAP

ABC Wash-N-Wax

The ultimate in car wash soap. It tackles the toughest dirt and grime while leaving a high wax shine.

ABC:WASH-WAX-1G	WASH AND WAX..1 GAL	\$ 9.98
ABC:WASH-WAX-P	WASH AND WAX..5 GAL	\$ 37.99
ABC:WASH-WAX-D	WASH AND WAX..55 GAL	\$ 409.00

Truck Wash Soap

This detergent based product is highly economical. It is ideal for keeping fleet vehicles clean.

CLN:TRUCK-WASH-P	TRUCK WASH SOAP..6 GAL	\$ 43.79
CLN:TRUCK-WASH-D	TRUCK WASH SOAP..55 GAL	\$ 263.25
CLN:TRUCKWASH-T	TRUCK WASH SOAP..275 GAL	\$ 680.11

Other Brands

CLN:TMT-D	BRUSHLESS TRUCK & TRAILER WASH..55 GAL	\$ 272.00
CLN:WASH-WAX-D	TRUCK WASH SOAP PLUS WAX..55 GAL	\$ 244.00
CLN:WASH-WAX-P	TRUCK WASH SOAP PLUS WAX..6 GAL	\$ 40.64
SPR:21101	NO SPOT NO STREAKS CAR WASH SOAP..1 GAL	\$ 14.61
SSG:VW-1	CAR WASH POWDER..9 OZ CAN	\$ 3.41
SSG:VW-4	CAR WASH POWDER..25 LB BUCKET	\$ 57.71
SSG:VW-5	CAR WASH SOAP..1 GAL	\$ 5.76
WAX:T75	ZIP WAX CAR WASH..16 OZ BOTTLE	\$ 3.33



MULTI-PURPOSE CLEANER

Parker Brothers Cleaner

Parker Brothers cleaner is designed to handle your toughest cleaning jobs, including degreasing engines, and cleaning wheels and tires. However, it is gentle enough to use on all interior surfaces, including vinyl, rubber, and fabrics.

PBI:M 93201	MULTI-PURPOSE CLEANER..1 GAL	\$ 10.06
PBI:M 93232	MULTI-PURPOSE CLEANER..32 OZ	\$ 4.05
PBI:M 93255	MULTI-PURPOSE CLEANER..55 GAL	\$ 485.68

Other Brands

SPR:26832	MULTI-PURPOSE CLEANER & DISINFECTANT..32 OZ PUMP BOTTLE	\$ 5.16
SPR:SPRAY-NINE-G	MULTI-PURPOSE CLEANER & DISINFECTANT..1 GAL	\$ 13.17
SPR:SPRAY-NINE-P	MULTI-PURPOSE CLEANER & DISINFECTANT..5 GAL	\$ 64.95
SPR:SPRAY-NINE-D	MULTI-PURPOSE CLEANER & DISINFECTANT..55 GAL	\$ 460.45
SSG:GOB-33	ORANGE CLEANER..33 OZ PUMP BOTTLE	\$ 3.00
SSG:GGC-33	GREEN CONCENTRATED CLEANER..33 OZ PUMP BOTTLE	\$ 3.38
SSG:GGC-5	GREEN CONCENTRATED CLEANER..5 GAL	\$ 67.50



DEGREASER

CLN Degreaser

Economical and concentrated, this degreaser will cut the heaviest grease on engines and equipment.

CLN:DEGREASER-P	HOT OR COLD DEGREASER..6 GAL	\$ 45.77
CLN:DEGREASER-D	HOT OR COLD DEGREASER..55 GAL	\$ 263.25

Other Brands

CLN:X25-P	EXTRA HEAVY DUTY DEGREASER..6 GAL	\$ 43.79
CLN:X25-D	EXTRA HEAVY DUTY DEGREASER..55 GAL	\$ 244.75
SPR:22732	GREZ-OFF DEGREASER..32 OZ PUMP BOTTLE	\$ 5.37
SPR:22701	GREZ-OFF DEGREASER..1 GAL	\$ 14.05
SPR:22705	GREZ-OFF DEGREASER..5 GAL	\$ 65.41
SPR:22755	GREZ-OFF DEGREASER..55 GAL	\$ 551.91
SPR:22555	ENGINE DEGREASER..55 GAL	\$ 730.92
SSG:EB-1	ENGINE BRITE ENGINE DEGREASER..16 OZ AEROSOL	\$ 3.68
SSG:EB-2A	ENGINE BRITE ENGINE DEGREASER..32 OZ BOTTLE	\$ 2.96
SSG:EB-5	ENGINE BRITE ENGINE DEGREASER..5 GAL	\$ 125.13
SSG:FEB-1	FOAMY ENGINE BRITE ENGINE DEGREASER..18 OZ AEROSOL	\$ 3.68
SSG:CEB-1	CITRUS ENGINE BRITE..15 OZ AEROSOL	\$ 4.53
SSG:CL-32	CONCENTRATED CLEANER / DEGREASER..32 OZ PUMP BOTTLE	\$ 3.83





AUTO DETAIL SUPPLIES

TIRE CLEANER

White Wall Cleaners

ABC:WHEEL-GRILL-1G	WHEEL AND GRILL CLEANER..1 GAL	\$ 9.70
ABC:WHEEL-GRILL-P	WHEEL AND GRILL CLEANER..5 GAL	\$ 53.98
CLN:WHITE-WALL-P	WHITE WALL CLEANER..6 GAL	\$ 36.42
SSG:WW-32	TIRE WHITE..32 OZ PUMP BOTTLE	\$ 2.73
SSG:WW-1	WHITE WALL CLEANER..16 OZ CAN	\$ 1.85



WHEEL CLEANER

Coated Wheel Cleaner

WAX:10 10 6 12	EAGLE MAG CLEANER..12 OZ BOTTLE	\$ 3.18
WAX:10 10 6 18	EAGLE MAG CLEANER..18 OZ BOTTLE	\$ 4.28
WAX:10 50 6 08	EAGLE ONE WHEEL CLEANER KIT..12 OZ BOTTLE	\$ 5.46
ARM:78012	QUICK SILVER II..25 OZ SPRAY	\$ 6.36
SSG:FWC-22	FOAMING WHEEL CLEANER..22 OZ AEROSOL	\$ 3.38

ABC Wheel and Grill Cleaner

Cleans and restores the shine to wire, chrome and mag wheels, wheel covers, and auto grills. DO NOT USE on clear coated chrome wheels, anodized, or painted wheels.

ABC:WHEEL-GRILL-1G	WHEEL AND GRILL CLEANER..1 GAL	\$ 9.70
ABC:WHEEL-GRILL-P	WHEEL AND GRILL CLEANER..5 GAL	\$ 53.98

SPECIALTY CLEANERS

Glass Cleaner

Please see GLASS CLEANER in the CLEANING SUPPLIES section.

Aluminum Cleaner

CLN:ALUM-CLN-P	ALUMINUM BRIGHTENER..6 GAL	\$ 58.10
CLN:ALUM-CLN-D	ALUMINUM BRIGHTENER..55 GAL	\$ 294.10

Exhaust Remover

CLN:DEW-BRIGHT-P	EXHAUST REMOVER..6 GAL	\$ 53.84
CLN:DEW-BRIGHT-D	EXHAUST REMOVER..55 GAL	\$ 268.15

Asphalt Release Agent

CLN:SUPER-SLIP-D	ASPHALT RELEASE AGENT...55 GAL DRUM	\$ 599.00
------------------	-------------------------------------	-----------

WINDSHIELD TREATMENTS

Rain Repellent

WAX:RAIN-X	WINDSHIELD WATER REPELLENT..3.5 OZ BOTTLE	\$ 2.79
------------	---	---------

Anti-Fog Treatment

NAC:NA128	NEVER FOG WIPES..24 WIPES PER CASE	\$ 18.50
-----------	------------------------------------	----------

AIR FRESHENERS

Air Fresheners

NAC:NA301	CHERRY VENT SCENTS..1EACH	\$ 0.66
SSG:DEOD-33	AUTOMOBILE INTERIOR DEODORIZER..33 OZ PUMP BOTTLE	\$ 3.12

FOR 50+ YEARS,
PARKER
BROTHERS
HAS BEEN
SERVING ATLANTA.
THANK YOU FOR
YOUR CONTINUED
SUPPORT!!

AUTO DETAIL SUPPLIES



TIRE AND VINYL DRESSING

ARM :110 10	ARMOR ALL PROTECTANT..10 OZ SPRAY	\$ 4.93
ARM :10160	ARMOR ALL PROTECTANT..16 OZ SPRAY	\$ 7.91
ARM :10326	ARMOR ALL PROTECTANT..32 OZ SPRAY	\$ 12.52
ARM :107 10	ARMOR ALL PROTECTANT..1 GAL	\$ 40.67
ARM :10861	ARMOR ALL WIPES..25 WIPES PER PACK	\$ 5.42
ARM :10861-6	ARMOR ALL WIPES..6 PACKS / 25 WIPES PER PACK	\$ 32.34
STP :65254	SON OF GUN PROTECTANT..10 OZ PUMP BOTTLE	\$ 3.84
ABC:TIRE-BRIGHT-1G	TIRE BRIGHT..1 GAL	\$ 19.24
ABC:TIRE-BRIGHT-P	TIRE BRIGHT..5 GAL	\$ 78.99
ABC:PROTECTOR-QT	VINYL-LEATHER-RUBBER PROTECTOR..532 OZL	\$ 6.70
ABC:PROTECTOR-1G	VINYL-LEATHER-RUBBER PROTECTOR..1 GAL	\$ 24.33
ABC:PROTECTOR-P	VINYL-LEATHER-RUBBER PROTECTOR..5 GAL	\$ 142.87
SSG:TS-17	TIRE SHINE..17 OZ AEROSOL	\$ 5.01
PER:NTBP 15	NO TOUCH TIRE CARE..18 OZ AEROSOL	\$ 4.05



WAX

Regular Wax

WAX:2667	KIT LIQUID CAR WAX..16 OZ BOTTLE	\$ 4.05
WAX:T 123	LIQUID TURTLE WAX..18 OZ BOTTLE	\$ 5.21
WAX:T222	SUPER HARD SHELL PASTE WAX..14 OZ CAN	\$ 5.67
WAX:T 360	EMERALD LIQUID WAX..16 OZ BOTTLE	\$ 12.47
WAX:M 0616	M EGUIARS #6 LIQUID WAX & CLEANER..16 OZ BOTTLE	\$ 8.81
3M :39026	LIQUID WAX..16 OZ. BOTTLE	\$ 10.85

POLISH

Car Polish

WAX:NF 76	NU FINISH LIQUID CAR POLISH 16 OZ BOTTLE	\$ 7.06
WAX:076 10	RAIN DANCE CAR POLISH..10 OZ BOTTLE	\$ 1.69
WAX:T241A	POLISHING COMPOUND..10.5 OZ BOTTLE	\$ 2.00

Chrome and Aluminum Polish

WAX:05100	MAG & ALUMINUM POLISH..5 OZ CAN	\$ 5.02
WAX:10120	RALLY CHROME POLISH..11 OZ BOTTLE..	\$ 1.72

RUBBING COMPOUNDS / BUFFING PADS

3M Perfect-It II Glaze

This medium cutting compound is used to remove 1200, 1500, and 2000 color sanding scratches. It's unique formulation produces minimal compound swirl marks.

3M :05974	PERFECT-IT 2 RUBBING COMPOUND..1 GAL	\$ 58.80
-----------	--------------------------------------	----------

3M Finesse It

Removes swirl marks while leaving a glazed finish. Designed for use on fully cured automotive paint.

3M :05928	FINESSE-IT FINISHING MATERIAL..1 QT	\$ 36.47
-----------	-------------------------------------	----------

Other Brands

WAX:086 10	#7 RUBBING COMPOUND..10 OZ BOTTLE	\$ 1.69
------------	-----------------------------------	---------

Buffing Pads

3M :05925	3" FINESSE-IT BUFFING PAD..20 PER BAG	\$ 57.69
3M :05700	9" SUPERBUFF BLUFFING PAD..1 EACH	\$ 23.13

Parker Brothers
gladly accepts
Visa, Mastercard
Discover &
American Express





AUTO DETAIL SUPPLIES

RUBBING COMPOUNDS / BUFFING PADS

Buffing Pads

3M :05713	9" HOOKIT SBS POLISHING PAD..1 EACH	\$ 18.24
3M :05721	3" WHITE COMPOUND PAD..1 EACH	\$ 13.29
3M :05723	8" PERFECT-IT FOAM COMPOUNDING PAD..2 EACH	\$ 26.19

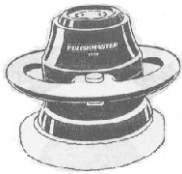

WATER HOSES AND NOZZLES

Gates Heavy-Duty Water Hose

These rugged hoses resist abrasions, weathering, and crushing. They have a working pressure of 200PSI. Under normal conditions, this should be the last hose you'll ever have to buy.

GAT :27107	SERVICE MASTER WATER HOSE..5/8" X 50'	\$ 95.00
GAT :27108	SERVICE MASTER WATER HOSE..3/4" X 50'	\$ 129.01

Other Brands

W/H:5/8X8FT	5/8" X 8' GOODYEAR WATER HOSE	\$ 18.90
W/H:5/8X75FT	5/8" X 75' GOODYEAR WATER HOSE	\$ 87.31
W/H:3/4X50FT	3/4" X 50' GOODYEAR WATER HOSE	\$ 60.10
W/H:3/4X75FT	3/4" X 75' GOODYEAR WATER HOSE	\$ 92.55
W/H:3/4X100FT	3/4" X 100' GOODYEAR WATER HOSE	\$ 143.22

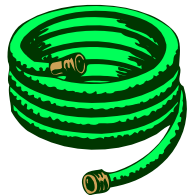

Water Nozzles

CAR :90016	7" BLACK WATER NOZZLE..1 EACH	\$ 6.76
MIL :S300	HANDY BEND WATER NOZZLE..GARDEN HOSE THREAD..1 EACH	\$ 26.58



MIL S300

Pressure Washer Accessories

CLN:GUN-ASSEMBLY	GUN ASSEMBLY WITHOUT WAND..1 EACH	\$ 35.00
CLN:WAND	GUN AND LANCE ASSEMBLY..1 EACH	\$ 52.50
CLN:50FT-HOSE	50' HIGH PRESSURE HOSE..1 EACH	\$ 79.75
CLN:100FT-HOSE	100' HIGH PRESSURE HOSE..1 EACH	\$ 171.05
CLN:AP 386188	3/8" X 50" STEAM CLEANER HOSE REEL..1 EACH	\$ 101.95
CLN:NOZZLE	COLOR CODED NOZZLE..1 EACH	\$ 9.36
CLN:NOZZLE-BLK	BLACK STEAM CLEANER NOZZLE..1 EACH	\$ 8.50
CLN:NOZZLE-BLUE	BLUE STEAM CLEANER NOZZLE..1 EACH	\$ 8.50
CLN:NOZZLE-GRN	GREEN STEAM CLEANER NOZZLE..1 EACH	\$ 7.08
CLN:NOZZLE-ORG	ORANGE STEAM CLEANER NOZZLE..1 EACH	\$ 8.50
CLN:NOZZLE-RED	RED STEAM CLEANER NOZZLE..1 EACH	\$ 7.08
CLN:NOZZLE-WHT	WHITE STEAM CLEANER NOZZLE..1 EACH	\$ 7.08
CLN:NOZZLE-YEL	YELLOW STEAM CLEANER NOZZLE..1 EACH	\$ 7.08
CLN:1/4M COUPLING	1/4" MALE COUPLING..1 EACH	\$ 9.15
CLN:1/4FM COUPLING	1/4" FEMALE QUICK COUPLING..1 EACH	\$ 3.81
CLN:COUPLING-M	3/8 MALE STEAM CLEANER COUPLERS..1 SET	\$ 7.80
CLN:COUPLING-FM	3/8 FEMALE STEAM CLEANER COUPLERS..1 SET	\$ 10.93
CLN:SWIVEL	3500 PSI PRESSURE WASHER SWIVEL..1 EACH	\$ 45.77
CLN:PROPORTIONER	PROPORTIONER VALVE..1 EACH	\$ 125.00
CLN:RT12	RAYCO PRESSURE WASHER FUEL FILTER..1 EACH	\$ 26.11
CLN:TANK-ASSEMBLY	PRESSURE WASHER TANK CONNECTOR ASSEMBLY..1 EACH	\$ 46.50



MONDAY-FRIDAY
8am-5pm a helpful
HUMAN voice will
always answer the
phone
(770)474-1286

BUCKETS AND CHAMOIS

Wash Bucket

SWC:EMPTY-PAIL	EMPTY 5 GAL PAIL..1 EACH	\$ 9.12
----------------	--------------------------	---------

Chamois

The ultimate car drying towel.

WAX:FS30	2 SQ FT CHAMOIS..1 EACH	\$ 10.28
WAX:FS36	2 1/2 SQ FT CHAMOIS..1 EACH	\$ 14.49
WAX:FS66	5 SQ FT CHAMOIS..1 EACH	\$ 17.63
WAX:TW222	TURTLE WAX CHAMOIS..WAX & CLEANER	\$ 4.37

Waterblade

This soft rubber squeegee is the quickest and easiest way to dry a car. It is safe on paint.

BRU:WATERBLADE	12" CAR DRYING SQUEEGEE..1 EACH	\$ 42.62
----------------	---------------------------------	----------

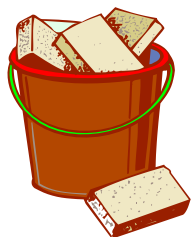

AUTO DETAIL SUPPLIES



BRUSHES

Body Brushes

BRU 400122 - Made of synthetic fleece wool. Cannot scratch the finest finishes.

BRU:400122	CAR WASH MITT..1 EACH	\$ 4.46
------------	-----------------------	---------

BRU 444FX - A 12in plastic block with 2.5in black horse hair and nylon bristles.

BRU:444FX	12" BLACK BODY BRUSH..1 EACH	\$ 17.29
-----------	------------------------------	----------

BRU 180210 - A 10in block with one threaded hole. It has 2.5in Nylex bristles.

BRU:180210	10" GREEN BODY BRUSH..1 EACH	\$ 17.35
------------	------------------------------	----------

PBO:468-Y 10" YELLOW TRUCK WASH BRUSH..1 EACH

PBO:468-Y	10" YELLOW TRUCK WASH BRUSH..1 EACH	\$ 19.50
-----------	-------------------------------------	----------

BRU 181009 - A 9in block with two threaded holes. It has soft white bristles.

BRU:181009	9" WHITE BODY BRUSH..1 EACH	\$ 12.42
------------	-----------------------------	----------

BRU 1214 - A 14in block with two threaded holes. It has 2.25in Nylex bristles.

BRU:181214	14" GREEN BODY BRUSH..1 EACH	\$ 21.53
------------	------------------------------	----------

BRU 180510 - A 10in block with one threaded hole. It features a split brush shape with two position 2.3in Nylex bristles

BRU:180510	10" GREEN DUAL SURFACE BODY BRUSH..1 EACH	\$ 18.28
------------	---	----------

PBO:1297-Y	DOUBLE SIDED YELLOW TRUCK WASH BRUSH..1 EACH	\$ 25.56
------------	--	----------

BRU 181010 - A 10in block with one threaded hole. It has 2.5in Prolene bristles. It can be used with phosphoric acid brightener solutions.

BRU:181010	10" WHITE ACID WASH BRUSH..1 EACH	\$ 12.45
------------	-----------------------------------	----------

BRU:180920	20" SOFT UTILITY BRUSH..1 EACH	\$ 4.67
------------	--------------------------------	---------

BRU:ACIDBRUSH	3/8" METAL HANDLE ACID BRUSH..1 EACH	\$ 0.20
---------------	--------------------------------------	---------

BRU 110432 - A flexible semi-circle shaped plastic block with two threaded holes at different angles filled with 3.7in Tampico bristles. It is designed to clean chrome exhaust stacks on large trucks

BRU:110432	EXHAUST STACK BRUSH..1 EACH	\$ 24.75
------------	-----------------------------	----------

Window Brushes

BRU:447	GREEN WINDOW BRUSH..1 EACH	\$ 13.16
---------	----------------------------	----------

BRU:200908	8" BLENDED WINDOW BRUSH..1 EACH	\$ 7.77
------------	---------------------------------	---------

Sidewall Brushes

BRU:290185	BLACK NYLON SIDEWALL BRUSH..1 EACH	\$ 5.02
------------	------------------------------------	---------

BRU:290285	BRASS SIDEWALL BRUSH..1 EACH	\$ 5.84
------------	------------------------------	---------

BRU:290385	STEEL SIDEWALL BRUSH..1 EACH	\$ 4.37
------------	------------------------------	---------

Utility Brushes

BRU:509L	LONG HANDLE NATURAL FIBER UTILITY BRUSH..1 EACH	\$ 6.29
----------	---	---------

BRU:200708	NYLON UTILITY BRUSH..1 EACH	\$ 6.98
------------	-----------------------------	---------

BRU:200720	LON HANDLED NYLON UTILITY BRUSH..1 EACH	\$ 8.39
------------	---	---------

Spoke Brushes

BRU:3614	10.5" WHITE SPOKE BRUSH..1 EACH	\$ 3.00
----------	---------------------------------	---------

BRU:530110	SMALL SPOKE BRUSH	\$ 2.46
------------	-------------------	---------

BRU:530216	SPOKE BRUSH..1 EACH	\$ 5.21
------------	---------------------	---------

CAR:93012	MAG WHEEL BRUSH..1 EACH	\$ 2.73
-----------	-------------------------	---------

Detail Brushes

BRU:490107	BRASS TOOTHBRUSH STYLE BRUSH..1 EACH	\$ 1.76
------------	--------------------------------------	---------

BRU:490307	NYLON TOOTHBRUSH STYLE BRUSH..1 EACH	\$ 1.37
------------	--------------------------------------	---------

BRU:490407	STEEL TOOTHBRUSH STYLE BRUSH..1 EACH	\$ 1.14
------------	--------------------------------------	---------

BRU:350206	VENT DUSTER BRUSH..1 EACH	\$ 1.65
------------	---------------------------	---------

CAR:93043	VENT/DASH BRUSH..1 EACH	\$ 1.30
-----------	-------------------------	---------

Wisk Brooms

BRU:440112	WHISK BROOM..1 EACH	\$ 2.76
------------	---------------------	---------

HANDLES

Threaded Handles

BRU:140160	5' WOOD THREADED WOOD HANDLE..1 EACH	\$ 4.29
------------	--------------------------------------	---------

BRU:140460	5' METAL THREADED WOOD HANDLE..1 EACH	\$ 4.78
------------	---------------------------------------	---------

BRU:140860	5' FIBERGLASS THREADED HANDLE..1 EACH	\$ 7.77
------------	---------------------------------------	---------

BRU:140596	8' METAL THREADED WOOD HANDLE..1 EACH	\$ 12.64
------------	---------------------------------------	----------

BRU:RIDGID	RIDGID BRACE..1 EACH	\$ 3.00
------------	----------------------	---------

BRU:140630	2.5' PLASTIC THREADED HANDLE..1 EACH	\$ 1.32
------------	--------------------------------------	---------

BRU:140360	5' TAPERED HANDLE..1 EACH	\$ 7.71
------------	---------------------------	---------



Bru 2004



Bru 2001np

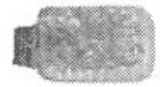

Bru 400122



Bru 444FX



Bru 180210



Bru 1214



Bru 180510

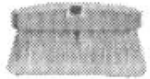

Bru 181010

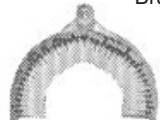

Bru 110432



Bru 200908
& 447



Bru 290185,
290285, 290385



Bru 200708



Bru 509L & 200720



Bru 3614



Bru 490107
Bru 490307
Bru 490407



Bru 440112



AUTO//INDUSTRIAL CHEMICALS

PENETRANTS
LUBRICANTS
SPRAY CARBURETOR CLEANER
DIP CARBURETOR CLEANER
FUEL INJECTOR CLEANER SYSTEM
INTAKE SYSTEM CLEANER
GAS TREATMENT
DIESEL FUEL CONDITIONER
BRAKE SUPPLIES
CONTACT/ELECTRIC MOTOR CLEANER
PARTS WASHING FLUID
VAT STRIPPERS
STARTING FLUID
WINDSHIELD WASHER SOLVENT
BATTERY PRODUCTS
COOLING SYSTEM PRODUCTS
TRANSMISSION PRODUCTS
ENGINE TREATMENTS
AIR CONDITIONING PRODUCTS
MISCELLANEOUS AUTOMOTIVE PRODUCTS
INDUSTRIAL CLEANERS AND DEGREASERS
MISCELLANEOUS INDUSTRIAL PRODUCTS

AUTO//INDUSTRIAL CHEMICALS



PENETRANTS

PB Blaster

This is the most cost effective, high performance product on the market today. It has a powerful, concentrated formula which uses capillary action to pull itself uphill into the most remote cracks and crevices. It frees rusted nuts and bolts by breaking the surface tension which hold them together. It also lubricates and protects.

P/B:16PB	PENETRATING CATALYST..12 OZ AEROSOL	\$ 3.99
P/B:PB128	PENETRATING CATALYST..1 GAL	\$ 31.84
P/B:PB5-P	PENETRATING CATALYST..5 GAL	\$ 103.38

Other Brands

W/D:8OZ	WD-40..8OZ	\$ 4.15
W/D:11OZ	WD-40..11 OZ	\$ 5.98
W/D:10032	WD-40 WITH SMART STRAW..12 OZ	\$ 6.21
W/D:1GALLON	WD-40..1 GAL	\$ 22.44
W/D:5GALLON	WD-40..5 GAL	\$ 115.66
W/D:DRUM	WD-40..55 GAL	\$ 986.94
W/D:PUMP-BOTTLE	EMPTY WD-40 APPLICATOR..1 EACH	\$ 3.30
SSG:L1-04	LIQUID WRENCH #1 PENETRANT..4 OZ BOTTLE	\$ 2.37
SSG:L1-06	LIQUID WRENCH #1 PENETRANT..6 OZ AEROSOL	\$ 3.27
SSG:L1-12	LIQUID WRENCH #1 PENETRANT..11 OZ AEROSOL	\$ 3.96
SSG:L1-16	LIQUID WRENCH #1 PENETRANT..16 OZ BOTTLE	\$ 5.55
SSG:L1-34	LIQUID WRENCH #1 PENETRANT..1 GAL	\$ 29.70



LUBRICANTS

LPS Greaseless Lubricant

This product lubricates even the most delicate mechanisms without picking up dust or dirt. It also penetrates to carry lubrication and corrosion inhibitors to hard to reach places. It also displaces moisture and will not stain.

LPS:00116	LPS#1 GREASELESS LUBRICANT..11 OZ AEROSOL	\$ 12.30
-----------	---	----------

LPS 2 General Purpose Lubricant

This product lubricates and loosens. It penetrates light dirt and rust. It is harmless to rubber, plastic, paint and finishes.

LPS:00216	LPS#2 INDUSTRIAL STRENGTH LUBRICANT..11 OZ AEROSOL	\$ 13.57
LPS:02128	LPS#2 INDUSTRIAL STRENGTH LUBRICANT..1 GAL	\$ 35.64

Other Brands

SSG:L2-04	LIQUID WRENCH #2 LUBRICANT..4 OZ BOTTLE	\$ 2.09
SSG:L2-12	LIQUID WRENCH #2 LUBRICANT..11 OZ AEROSOL	\$ 3.19
SSG:L2-34	LIQUID WRENCH #2 LUBRICANT..1 GAL	\$ 12.68
SSG:L4-12	LIQUID WRENCH #4 FOAMING PENETRANT / LUBRICANT..9 OZ AEROSOL	\$ 5.93
P/B:PB50	ALL PURPOSE LUBE..8OZ AEROSOL	\$ 3.59
LPS:02016	TXK PENETRANT, LUBRICANT, & PROTECTANT..11 OZ AEROSOL	\$ 5.12

Solder Seal/Gunk Liquid Wrench 3 w/Teflon

This product is non-flammable and does it all. It frees rusted and corroded parts and seized joints. It also lubricates, dispenses moisture, inhibits corrosion, and stops squeaks and squeals.

SSG:L3-04CD	LIQUID WRENCH #3 LUBRICANT WITH TEFLON..4 OZ AEROSOL	\$ 1.31
-------------	--	---------

Other Brands

SSG:L5-08	SPRAY LUBRICANT WITH PTFE..6 OZ AEROSOL	\$ 5.07
SSG:L5-12	SPRAY LUBRICANT WITH PTFE..11 OZ AEROSOL	\$ 5.07
P/B:16-TDL	TEFLON DRY LUBE..11 OZ AEROSOL	\$ 5.41





AUTO//INDUSTRIAL CHEMICALS

LUBRICANTS

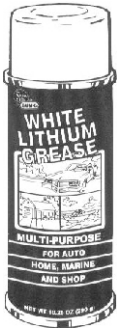

Solder Seal/Gunk Silicone Spray

This product has a high viscosity formula which eliminates squeaks and lubricates all kinds of household and mechanical equipment. It is compatible with all metals, rubber, plastic, and wood.

SSG:M 9-14	SILICONE LUBRICANT..11 OZ AEROSOL	\$ 3.35
------------	-----------------------------------	---------

Other Brands

PER:80070	SILICONE SPRAY LUBRICANT..16 OZ AEROSOL	\$ 3.49
3M:08877	SILICONE LUBRICANT PLUS (WET)..16 OZ. AEROSOL CAN	\$ 4.68
3M:08897	SILICONE LUBRICANT (DRY)..8 OZ. AEROSOL CAN	\$ 4.49
3M:08946	CLEAR SILICONE PASTE..8 OZ. CAN	\$ 18.44

Solder Seal/Gunk White Lithium Grease

This product reduces friction in all metal-to-metal and metal-to-plastic applications. It protects against rust and corrosion and will not melt, run, freeze, or wash off.

SSG:L6-16	WHITE LITHIUM GREASE..10.25 OZ AEROSOL	\$ 4.01
SSG:L6-66	WHITE LITHIUM GREASE..1LB TUB	\$ 5.21

Other Brands

PER:81981	WHITE LITHIUM GREASE..16 OZ AEROSOL	\$ 4.63
PER:80345	WHITE LITHIUM GREASE..1.5 OZ TUBE	\$ 1.97
LP S:03816	WHITE LITHIUM GREASE WITH TEFLON ..10 OZ AEROSOL	\$ 7.37
P/B:16LG	WHITE LITHIUM GREASE..11 OZ AEROSOL	\$ 4.75
AGS:WL8	WHITE LITHIUM GREASE..8 OZ TUBE	\$ 5.13
AGS:WL15	WHITE LITHIUM GREASE..1LB	\$ 4.13
3M:08875	WHITE LITHIUM GREASE..10.5 OZ. AEROSOL CAN	\$ 6.51

Solder Seal/Gunk Chain Lube

This product penetrates, lubricates, and clings to all types of open chains and flexible cables. The heavy duty version (SSG L7-16) is formulated with Moly to withstand high temperatures and adhere to surfaces under high RPM's.

SSG:L7-11	INDUSTRIAL CHAIN LUBE WITH MOLY..15 OZ AEROSOL	\$ 3.51
SSG:M L-2S	CYCLE CHAIN LUBE..14 OZ AEROSOL	\$ 2.75

Other Brands

PER:80075	CHAIN LUBE..6 OZ AEROSOL	\$ 3.15
LP S:02416	CHAIN AND WIRE ROPE LUBRICANT..11 OZ AEROSOL	\$ 9.72
P/B:8TCL	TRACK & CABLE LUBE..7 OZ AEROSOL	\$ 3.77
P/B:16-GDL	GARAGE DOOR LUBE..16 OZ AEROSOL	\$ 4.88

Moly

LP S:02516	FORCE 842 DRY MOLY LUBRICANT..11 OZ AEROSOL	\$ 18.43
------------	---	----------

Permatex Anti-Seize Lubricant

This product is a highly refined blend of aluminum, copper, and graphite lubricants. It is used during assembly to prevent galling, corrosion, and seizing, and to assure easier disassembly (temperature range -60F to 1200F).

PER:80078	ANTI-SEIZE LUBRICANT..8 OZ BOTTLE	\$ 9.61
PER:81343	ANTI-SEIZE LUBRICANT..1 OZ TUBE	\$ 2.59
PER:81464	ANTI-SEIZE LUBRICANT..12 OZ AEROSOL	\$ 11.43

Other Brands

PER:81950	ULTRA SLICK ENGINE ASSEMBLY LUBE..4 OZ BOTTLE	\$ 3.78
L/G:31295	RED ASSEMBLY LUBE..1LB TUB	\$ 10.95
CRC:SL3331	ENGINE ASSEMBLY LUBE..10 OZ TUBE	\$ 6.88

Household Lubricants

MAR:005	LUBRICATING OIL..4 OZ CAN..	\$ 1.19
MAR:012	MARVEL MYSTERY OIL..16 OZ CAN	\$ 3.95
MAR:013	MARVEL MYSTERY OIL..1 QT	\$ 6.30
MAR:014	MARVEL MYSTERY OIL..1 GAL	\$ 21.27
W/D:3IN1	MULTI-PURPOSE LUBRICANT..3 OZ DRIP CAN	\$ 2.49

FOR 50+ YEARS,
PARKER
BROTHERS
HAS BEEN
SERVING ATLANTA.
THANK YOU FOR
YOUR CONTINUED
SUPPORT!!

Parker Brothers
gladly accepts
Visa, Mastercard
Discover &
American Express

AUTO//INDUSTRIAL CHEMICALS



SPRAY CARBURETOR CLEANER

Solder Seal/Gunk Carb Medic

This product removes dirt, varnish, gum, carbon deposits, and sludge from carburetors and combustion chambers of gasoline engines.

SSG:M 48-14H	CARB MEDIC CARBURETOR CLEANER..13 OZ AEROSOL	\$ 2.64
--------------	--	---------

Other Brands

P/B: FIC 16	FUEL INJECTOR CLEANER..16 OZ BOTTLE	\$ 4.00
CRC:05079	CARBURETOR CLEANER..12 OZ AEROSOL	\$ 3.90
SSG:M 47-12	FUEL INJECTOR AIR INTAKE CLEANER..12 OZ AEROSOL	\$ 3.47
BER:0117	B-12 CHEM TOOL CARBURETOR CLEANER..16.25 OZ AEROSOL	\$ 3.18
3M:08796	CHOKE AND CARB. CLEANER..12.5 OZ. CAN	\$ 4.10
3M:08866	THROTTLE PLATE & CARB CLEANER..8.5 OZ. AEROSOL CAN	\$ 4.78
GUM:2230	CARB/CHOKE CLEANER..19 OZ AEROSOL	\$ 7.03
GUM:2231	CARB/CHOKE CLEANER..13 OZ AEROSOL	\$ 3.58
GUM:7459	CARB/CHOKE CLEANER..16.25 OZ AEROSOL	\$ 2.47
KRY:K1333	TUNER CLEANER..12 OZ CAN	\$ 10.36



DIP CARBURETOR CLEANER

Berryman Carburetor Dip

This product is a powerful, heavy-duty, hard parts cleaning compound.

BER:0901	CARBURETOR / PARTS CLEANER..1 GAL	\$ 30.32
BER:BASKET	1 GAL CARBURETOR / PARTS CLEANER BASKET..1 EACH	\$ 5.88
BER:0905	CARBURETOR / PARTS CLEANER..5 GAL	\$ 135.98
BER:0996	CARBURETOR / PARTS CLEANER WITH BASKET..96 OZ	\$ 23.98
BER:0950	5 GAL CARBURETOR / PARTS CLEANER BASKET..1 EACH	\$ 14.86

Other Brands

SSG:HS5-LB	HYDRO-SEAL CARBURETOR CLEANER..5 GAL	\$ 125.13
SSG:HS-8D	HYDRO-SEAL CARBURETOR CLEANER..50 GAL	\$ 102.50
SSG:B-5	PARTS BASKET FOR 5 GALLON HYDRO-SEAL..1 EACH	\$ 13.71



FUEL INJECTOR CLEANER SYSTEM

3M Fuel Injector Cleaner

This product is designed to quickly remove varnish, gum, and other deposits from fuel injectors. It is conveniently dispensed through 3M's fuel injector cleaner hose. It restores injector efficiency and improves fuel atomization. Recommended for professional use on gasoline engines.

3M:08840	FUEL SYSTEM HARDWARE/ADAPTERS..1 KIT	\$ 525.00
3M:08912	FUEL INJECTOR CLEANER..16 OZ. AEROSOL CAN	\$ 17.27

Hardware And Accessories

3M:08828	PRESSURE GAUGE/REGULATOR FOR INJECTOR KIT..1 EACH	\$ 129.78
3M:08837	FUEL INJECTOR CLEANER CAN HANGER..1 EACH	\$ 9.38
3M:08917	FUEL SYSTEM CLEANER ADAPTER..7/16" X 20 THREADED RIGHT ANGLE..1 EACH	\$ 27.50
3M:08920	FUEL SYSTEM CLEANER ADAPTER..5/16" HOSE..1 EACH	\$ 19.25
3M:08922	FUEL SYSTEM CLEANER ADAPTER..5/8" X 18 THREADED TBI..1 EACH	\$ 28.82
3M:08931	FUEL SYSTEM CLEANER ADAPTER..5/16" X 32 THREADED SCHRADER..1 EACH	\$ 42.17
3M:08838	CLEANER HOSE FOR FUEL INJECTION KIT..1 EACH	\$ 69.42
3M:08845	14MM X 1.5 THREAD PLUG..1 EACH	\$ 14.58
3M:08854	FUEL SYSTEM CLEANER ADAPTER..5/16 ID FEMALE QUICK CONNECT..1 EACH	\$ 28.50
3M:08855	FUEL SYSTEM CLEANER ADAPTER..LOOP 7/16 & 9/16 ID FEMALE QUICK CONNECT 1 EACH	\$ 53.18
3M:08856	FUEL SYSTEM CLEANER ADAPTER..LOOP 1/4 & 5/16 OD MALE QUICK CONNECT 1 EACH	\$ 43.65
3M:08857	FUEL SYSTEM CLEANER ADAPTER..12-1.5 MM THREADED SWIVEL NUT..1 EACH	\$ 23.36
3M:08858	FUEL SYSTEM CLEANER ADAPTER..12-1.5 MM THREADED BANJO BOLT..1 EACH	\$ 18.03
3M:08862	FUEL SYSTEM CLEANER ADAPTER..LOOP 1/4 & 5/16 OD MALE SLIP-FIT HOSE END..1 EACH	\$ 30.29

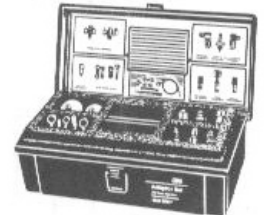



AUTO//INDUSTRIAL CHEMICALS

GAS TREATMENTS

Chevron Techron

This concentrated formula is designed to improve the performance of modern fuel systems. It's high detergent formula cleans clogged fuel injectors, increasing fuel economy and reducing emissions

CHE:TECHRON-12OZ	FUEL INJECTOR CLEANER..12 OZ BOTTLE	\$ 8.06
CHE:TECHRON-20OZ	FUEL INJECTOR CLEANER..20 OZ BOTTLE	\$ 12.01

Other Brands

STP:78573	GAS TREATMENT 5.25 OZ	\$ 2.18
STP:65045	GAS TREATMENT..8 OZ BOTTLE	\$ 3.09
STP:78575	FUEL INJECTION CLEANER ..5.25 OZ	\$ 4.18
STP:00515	FUEL INJECTOR CLEANER ..12 OZ BOTTLE	\$ 2.59
STP:78340	GAS TREATMENT..12 OZ BOTTLE	\$ 2.79
STP:78342	CONCENTRATED INJECTOR CLEANER..12OZ BOTTLE	\$ 3.14
SSG:M 48-16	CARB MEDIC CARBURETOR CLEANER..12 OZ BOTTLE	\$ 2.15
SSG:M 23-12	GAS TREATMENT..12 OZ BOTTLE	\$ 2.01
SSG:M 52-12	CONCENTRATED FUEL INJECTOR CLEANER..12 OZ BOTTLE	\$ 2.91
SSG:M 49-12	FUEL INJECTOR & CARBURETOR CLEANER..12 OZ BOTTLE	\$ 2.09
P/B:FIC 16	FUEL INJECTOR CLEANER..16 OZ BOTTLE	\$ 4.00
LOP :10020	LUCAS FUEL INJECTOR CLEANER..5.25 OZ BOTTLE	\$ 3.45
GUM :1373	CARB/ FUEL INJECTOR CLEANER..12 OZ BOTTLE	\$ 2.05
GUM :7918	XTRA FUEL INJECTION CLEANER..12 OZ BOTTLE	\$ 3.57
BER:0113	B 12 FUEL TREATMENT..13 OZ	\$ 3.18
BER:0116	CHEM TOOL FUEL TREATMENT..16 OZ	\$ 3.12
BER:1112	CHEM TOOL FUEL INJECTOR CLEANER..12 OZ	\$ 2.86



Fuel Additives

ANT:ISO-HEET	FUEL SYSTEM DRIER AND ANTIFREEZE..12 OZ BOTTLE	\$ 2.28
ANT:GAS-LINE	HEET GAS LINE ANTIFREEZE..12 OZ BOTTLE	\$ 1.99
LOP:10003	LUCAS FUEL STABILIZER..1 QT	\$ 8.93
PRI:104	104 PLUS OCTANE BOOST..16 OZ BOTTLE	\$ 4.99
PRI:SF 16	SEA FOAM MOTOR TUNE UP..16 OZ BOTTLE	\$ 7.89
PRI:22208	STA BIL FUEL STABILIZER..8 OZ BOTTLE	\$ 5.58
PRI:14308	STARTRON FUEL ADDITIVE..8 OZ BOTTLE	\$ 6.89
SSG:M 51-12	OCTANE BOOSTER..12 OZ BOTTLE	\$ 2.85
SSG:M 50-12	LEAD SUBSTITUTE..12 OZ BOTTLE	\$ 2.64
SSG:M 58-08	FUEL STABILIZER..8 OZ BOTTLE	\$ 6.12
SSG:GS-3	TWIN PAK MILEAGE IMPROVER..10 OZ OIL TREATMENT & 12 OZ FUEL TREATMENT	\$ 8.03

DIESEL FUEL CONDITIONER

Diesel Fuel Conditioner

This product keeps injectors clean by dissolving gum and varnish. It helps to prevent rust and corrosion build up and enhance combustion.

SSG:M 71-40	DIESEL FUEL CONDITIONER..5 GAL	\$ 46.40
SSG:M 24-12	DIESEL TONE FUEL CONDITIONER..12 OZ BOTTLE	\$ 2.15
SSG:M 73-08	DIESEL FUEL DRYER..8 OZ BOTTLE	\$ 4.67



PARKER, BROTHERS, INC.
 PARKER, BROTHERS, INC.
 PARKER, BROTHERS, INC.

AUTO//INDUSTRIAL CHEMICALS



DIESEL FUEL CONDITIONER

Other Brands

P/S:3025	DIESEL KLEEN ..32OZ BOTTLE	\$ 7.99
P/S:8025	DIESEL FUEL WATER REMOVER.32 OZ BOTTLE	\$ 36.69
P/S:9016	BIO KLEEN BIOCID..TREATS 320 GALLONS..16 OZ BOTTLE	\$ 96.23
P/S:9225P	DIESEL CLEAN + PETRO FRESH..32 OZ BOTTLE	\$ 9.95
P/S:9041	BIO KLEEN BIOCID..TREATS 2000 GALLONS..96 OZ BOTTLE	\$ 9.95

Diesel Fuel Anti-Gel

Diesel Fuel with Anti-Gel helps to retard wax and gelling during cold weather. It also lowers the pour point of diesel fuel and reduces the risk of fuel filter icing.

SSG:M 72-34	DIESEL FUEL CONDITIONER WITH ANTI-GEL..1 GAL	\$ 27.90
SSG:M 72-40	DIESEL FUEL CONDITIONER WITH ANTI-GEL..5 GAL	\$ 77.24
SSG:M 22-16	DIESEL FUEL ANTI-GEL..15 OZ BOTTLE	\$ 5.42
SSG:M 69-12	DIESEL FUEL CONDITIONER WITH ANTI-GEL..12 OZ BOTTLE	\$ 4.73
SSG:M 69-32	DIESEL FUEL CONDITIONER WITH ANTI-GEL..32 OZ BOTTLE	\$ 9.32
SSG:M 69-96	DIESEL FUEL CONDITIONER WITH ANTI-GEL..96 OZ BOTTLE	\$ 22.80

Other Brands

P/S:1016	DIESEL FUEL CONDITIONER WITH ANTIGEL...16 OZ BOTTLE	\$ 7.09
P/S:1025	DIESEL FUEL SUPPLEMENTS WITH ANTI-GEL..TREATS 100 GAL..32 OZ BOTTLE	\$ 14.39
P/S:1080	DIESEL FUEL SUPPLEMENTS WITH ANTI-GEL..TREATS 250 GAL..80 OZ BOTTLE	\$ 7.79

BRAKE SUPPLIES

Solder Seal/Gunk Brake Cleaner

Designed to quickly remove brake dust, brake fluid, grease, oil, and other contaminants, this aerosol cleaner is ideal for brake clean up and small parts washing.

SSG:M 7-20	BRAKE CLEANER ..20 OZ AEROSOL	\$ 3.21
SSG:M 7-15	NON-CHLORINATED BRAKE CLEANER..15 OZ AEROSOL	\$ 2.78

Other Brands

SSG:BRK-CLN-E	NEXT DIMENSION BRAKE CLEANER..14 OZ AEROSOL	\$ 2.92
SSG:BRK-CLN-P	NEXT DIMENSION BRAKE CLEANER..5 GAL	\$ 82.49
SSG:BRK-CLN-D	NEXT DIMENSION BRAKE CLEANER..55 GAL	\$ 912.90
CRC:05089	BRAKLEEN..19 OZ AEROSOL	\$ 4.69
CRC:05088	NON-CHLORINATED BRAKLEEN..14 OZ AEROSOL	\$ 2.92
CLN:BRK-CLN-D	BLAST OFF BRAKE CLEANER..55 GAL	\$ 551.56
3M:08880	BRAKE CLEANER..14 OZ. AEROSOL CAN	\$ 3.00
3M:08895	NON-CHLORINATED BRAKE CLEANER..14 OZ. AEROSOL CAN	\$ 2.09

Permatex Disc Brake Quiet

This product stops brake squeal by dampening vibration at the caliper/brake pad interface. It also provides for a better fit, makes for easier disassembly, and protects against corrosion.

PER:82017	DISC BRAKE QUIET..4 OZ BOTTLE	\$ 2.88
PER:80729	DISC BRAKE QUIET..2 / .25 OZ POUCHES	\$ 2.44
PER:80077	DISC BRAKE QUIET..12 OZ AEROSOL	\$ 5.76

Other Brands

SSG:M 6-04	DISC BRAKE QUIET..4 OZ BOTTLE	\$ 2.64
SSG:M 7-25	SQUEAL MEDIC BRAKE CURE..11.25 OZ AEROSOL	\$ 5.00

Permatex Ultra Disc Brake Caliper Lube

This environmentally friendly, non-melting, pure synthetic lubricant is formulated to prevent long bolt and sleeve seizing and galling.

PER:24110	DISC BRAKE LUBE..8 OZ BOTTLE WITH BRUSH	\$ 13.35
-----------	---	----------

Other Brands

SSG:L6-07	SYNTHETIC CALIPER GREASE..2 / 7 GRAM PACKS	\$ 3.12
3M:08945	BRAKE LUBRICANT AND ANTI SEIZE..8OZ CAN	\$ 13.65

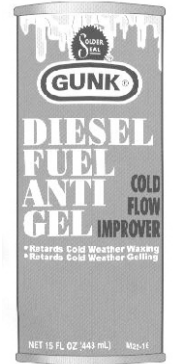



AUTO//INDUSTRIAL CHEMICALS

BRAKE SUPPLIES

Permatex Ceramic Extreme Brake Parts Lube

This 100% synthetic lubricant coupled with real synthetic solids makes this ur longest lasting, most temperature resistant way to silence brake noise. (-65F - 2800f)

PER:24125	EXTREME CERAMIC BRAKE LUBE..8 OZ BOTTLE WITH BRUSH	\$ 11.31
-----------	--	----------

Solder Seal/Gunk Air Brake Antifreeze

SSG:M 28-32	AIR BRAKE ANTI-FREEZE..32 OZ BOTTLE	\$ 4.31
SSG:M 28-34	AIR BRAKE ANTI-FREEZE..1GAL	\$ 15.99

CONTACT/ELECTRIC MOTOR CLEANER

Solder Seal/Gunk Electric Motor Contact Cleaner

This non-flammable, non-conductive cleaning solvent is for use on alternators, generators, starters, contact relays, and other electrical components

SSG:NM -1	ELECTRIC MOTOR / CONTACT CLEANER..20 OZ AEROSOL	\$ 5.27
SSG:NM -4	ELECTRONICS CLEANER..4.5 OZ AEROSOL	\$ 3.38

Other Brands

PER:82588	ELECTRICAL CONTACT CLEANER..15 OZ AEROSOL	\$ 12.58
LP S:03116	CFC FREE ELECTRIC CONTACT CLEANER..11 OZ AEROSOL	\$ 16.17
LP S:04016	NO FLASH ELCTRO CONTACT CLEANER..15 OZ AEROSOL	\$ 31.58

PARTS WASHING FLUID

142 Flash Parts Washing Fluid

This is a non flammable product. It is very effective at cutting the toughest grease and grime and is much safer than mineral spirits or kerosene.

CLN:PARTS-WASH-P	142 FLASH PARTS WASHER SOLVENT..5 GAL	\$ 73.25
CLN:PARTS-WASH-D	142 FLASH PARTS WASHER SOLVENT..55 GAL	\$ 618.60

Other Brands

SPR:37801	BIODEGRADABLE PARTS WASHER FLUID..1 GAL	\$ 12.75
SSG:SS-22	SUPER SPRAY PARTS & SURFACE CLEANER..22 OZ AEROSOL	\$ 5.00

Parts Cleaning Brush

BRU:530710	PARTS CLEANING BRUSH..1 EACH	\$ 6.52
------------	------------------------------	---------

VAT STRIPPER

ABC Aluminum Safe Vat Stripper

Designed to be used in a hot vat or recirculating wash unit, Aluminum Safe Vat Stripper removes grease, oil and dirt from aluminum, zinc, their alloys, and babbitt metals

ABC:ALKA 150-P	ALKA 150 ALUM SAFE VAT STRIPPER...5 GAL	\$ 74.65
ABC:ALKA 150-D	ALKA 150 ALUM SAFE VAT STRIPPER ..55 GAL	\$ 557.86

STARTING FLUID

Solder Seal/Gunk Thrust Starting Fluid

Provides quick starting of all gas engines and diesel engines without glow plugs. It is effective to -65F.

SSG:M 38-15	STARTING FLUID..11 OZ AEROSOL	\$ 2.48
SSG:M 39-11	LIQUID FIRE STARTING FLUID..7.5 OZ AEROSOL	\$ 2.57



AUTO//INDUSTRIAL CHEMICALS



WINDSHIELD WASHER SOLVENT

Windshield Washer Solvent

This product is specially formulated to clear windshields of dirt, bug stains, ice and frost. It contains antifreeze components for maximum protection

P/G:WS-SOLVENT-C	WINDSHIELD WASHER SOLVENT..6 / 1 GAL	\$ 13.99
P/G:WS-SOLVENT-D	WINDSHIELD WASHER SOLVENT..55 GAL	\$ 136.50

Other Brands

PRI:KIN 16	16 OZ TO 135 GAL WINDSHIELD WASHER CONCENTRATE..16 OZ	\$ 24.66
SSG:M 5-06	CONCENTRATED WINDSHIELD WASHER SOLVENT..6 OZ BOTTLE	\$ 1.17
SSG:M 5-16	CONCENTRATED WINDSHIELD WASHER SOLVENT..16 OZ BOTTLE	\$ 2.57
CLN:SHIMMER-P	WIND SHIELD SOLVENT CONCENTRATE..6 GAL	\$ 41.00
CLN:SHIMMER-D	WIND SHIELD SOLVENT CONCENTRATE..55 GAL	\$ 203.55

BATTERY PRODUCTS

Permatex Battery Cleaner

Spray it on and just three minutes later wash corrosion away.

PER:80369	BATTERY CLEANER..6 OZ AEROSOL	\$ 3.02
-----------	-------------------------------	---------

Other Brands

SSG:BTC4	BATTERY TERMINAL CLEANER..5 OZ AEROSOL	\$ 2.70
KRY:K51336	BATTERY CLEANER..12 OZ CAN	\$ 5.04

Permatex Battery Protector

This product stops terminal corrosion and increases battery life. Spray it on batteries in use or in storage.

PER:80370	BATTERY PROTECTOR AND SEALER..6 OZ AEROSOL	\$ 3.07
-----------	--	---------

Other Brands

SSG:BTP4	BATTERY TERMINAL PROTECTOR..4.5 OZ AEROSOL	\$ 2.70
KRY:K51307	BATTERY PROTECTOR..12 OZ CAN	\$ 4.71
BAT:NCP2	BATTERY TERMINAL PROTECTORS..100 PER CAN	\$ 15.71

Ignition Sealer

KRY:K1304	IGNITION SEALER..12 OZ CAN	\$ 4.71
-----------	----------------------------	---------

Battery Acid

BAT:5G.ACID	BATTERY ACID..5 GAL	\$ 22.00
-------------	---------------------	----------

COOLING SYSTEM PRODUCTS

Bars Leaks Radiator Repair

Bars Leaks seals radiator leaks fast. It is specially formulated to work in all cooling systems. It lubricates as it circulates. O.E. in Ford and GM.

BAR:1194	BARS LEAK..5.5 OZ BOTTLE	\$ 2.00
BAR:1196	BARS LEAK..10 OZ BOTTLE	\$ 3.78
BAR:HDC	BARS LEAK CONCENTRATE..2.1 OZ	\$ 1.65

Other Brands

SSG:C1-05	M-P RADIATOR SEALANT..5.5 OZ BOTTLE	\$ 2.43
SSG:C5-51B	POWDERED RADIATOR REPAIR..2 OZ CAN	\$ 1.80
SSG:C5-51D	POWDERED RADIATOR REPAIR DISPLAY..12 / 2 OZ CANS	\$ 10.04
SSG:C6-16	HEAVY DUTY BLOCK SEAL..15 OZ BOTTLE	\$ 2.51
SSG:C12-53	RADIATOR PRESSURE SEAL..2 OZ CAN	\$ 1.19
PER:09104	RADIATOR REPAIR KIT..1 KIT	\$ 8.58

Solder Seal/Gunk Water Pump Lube

This product mixes with all ethylene glycol based antifreeze. It prevents evaporation and formation of rust and corrosion while lubricating and protecting all metals.

SSG:C10-12	ANTI-RUST WATER PUMP LUBE..11 OZ BOTTLE	\$ 1.62
------------	---	---------

Solder Seal/Gunk 10 Minute Flush

This product quickly removes grease, scum, rust, and scale. It is a one step process which will allow antifreeze to flow efficiently to all parts of the cooling system.

SSG:C14-12	10 MINUTE RADIATOR FLUSH..11 OZ BOTTLE	\$ 1.79
------------	--	---------

Other Brands

SSG:C21-24	SUPER RADIATOR FLUSH..22 OZ BOTTLE	\$ 4.31
SSG:C22-32	HEAVY DUTY RADIATOR CLEANER..32 OZ BOTTLE	\$ 6.45





AUTO//INDUSTRIAL CHEMICALS

COOLING SYSTEM PRODUCTS

Solder Seal/Gunk Engine Coolant

Recommended for all air conditioned vehicles, Liquid Cool Engine Coolant prevents overheating, vapor lock, acid formation, corrosion, and rust.

SSG:C 15-32	LIQUID KOOL ENGINE COOLANT..30 OZ CAN	\$ 3.15
-------------	---------------------------------------	---------

Baldwin Supplemental Cooling Additives

Supplemental Cooling Additives (SCA's) are added to diesel cooling systems to neutralize acids created by the combustion process. They also provide a special chemical barrier around wet sleeve liner which greatly reduces pitting.

BMC:CS5008	BMC COOLANT ADDITIVE..1 PINT	\$ 4.10
BMC:CS5009	BMC COOLANT ADDITIVE..1/2 GAL	\$ 15.06
BMC:CS5058	BMC BTA PLUS ADDITIVE..1/2 GAL	\$ 16.17

Baldwin SCA's Test Strips

BMC:CTK5029	BMC COOLANT TEST KIT..1 EACH	\$ 66.41
-------------	------------------------------	----------

TRANSMISSION PRODUCTS

Solder Seal/Gunk TransMedic

While reducing friction, TransMedic helps eliminate slippage, down-shifting, rough shifting, sluggish action and gear whine

SSG:M 36-16	TRANS-MEDIC TRANSMISSION CONDITIONER..12 OZ BOTTLE	\$ 4.31
-------------	--	---------

Other Brands

SSG:M 14-32	AUTOMATIC TRANSMISSION SEALER & CONDITIONER..32 OZ BOTTLE	\$ 6.45
SSG:M 15-12	TRANSMISSION SEALER & CONDITIONER..12 OZ BOTTLE	\$ 2.57
LOP:10009	LUCAS TRANSMISSION FIX..24 OZ BOTTLE	\$ 11.01
L/G:96001	KOOL IT COOLANT TREATMENT..16OZ BOTTLE	\$ 12.00
L/G:19001	KOOLER KLEEN TRANSMISSION FLUSH..13.25 OZ BOTTLE	\$ 10.14

Transmission Fluid Supplements

L/G:60902	RED ATF TRANSMISSION FLUID SUPPLEMENT..10 OZ BOTTLE	\$ 8.76
L/G:61910	BLACK ATF TRANSMISSION FLUID..SUPPLEMENT..10 OZ BOTTLE	\$ 11.76
L/G:62005	MERCON 5 TRANSMISSION FLUID SUPPLEMENT..10 OZ BOTTLE	\$ 10.26
L/G:63010	PLATINUM ATF TRANSMISSION FLUID SUPPLEMENT..10 OZ BOTTLE	\$ 16.52

Transmission Assembly Lube

L/G:19260	TRANSMISSION ASSEMBLY LUBE..1 LB TUB	\$ 7.60
-----------	--------------------------------------	---------

ENGINE TREATMENTS

Solder Seal/Gunk Motor Flush

Motor Flush cleans internal engine parts by removing gums, varnishes, and sludge. It also releases sticky valves and piston rings allowing oil to circulate freely.

SSG:M F-3	5 MINUTE MOTOR FLUSH..32 OZ BOTTLE	\$ 4.73
-----------	------------------------------------	---------

Solder Seal/Gunk Valve Medic

Valve Medic quickly quiets noisy lifters by dissolving gum, sludge, and dirt deposits from valve lifters.

SSG:M 37-12	VALVE-MEDIC..12 OZ BOTTLE	\$ 1.95
-------------	---------------------------	---------

Solder Seal/Gunk Motor Medic

Motor Medic reduces friction and wear, while keeping moving parts clean.

SSG:M 18-15	MOTOR MEDIC OIL TREATMENT..15 OZ AEROSOL	\$ 4.16
-------------	--	---------

Other Brands

SSG:M 62-32	NU POWER ENGINE TREATMENT..32 OZ BOTTLE	\$ 10.07
SSG:M 16-16	BEARIN' SEAL ENGINE SEALER..12 OZ BOTTLE	\$ 3.05
STP:66079	OIL TREATMENT..15 OZ BOTTLE	\$ 3.92
LOP:10001	LUCAS OIL STABILIZER..1 QT	\$ 11.45
LOP:10002	LUCAS OIL STABILIZER..1 GAL	\$ 26.94



AUTO//INDUSTRIAL CHEMICALS



AIR CONDITIONING PRODUCTS

Refrigerants

FRE:134-C	SUVA 134A FREON..12 / 12 OZ CANS	\$ 67.57
FRE:SD-134-EZ	134A WITH OIL AND STOP LEAK..12 OZ CAN	\$ 15.47
FRE:6537	134A MAX CHARGE..11 OZ 134A / 2 OZ OIL CHARGE / 10Z LEAK SEAL..14 OZ CAN	\$ 10.27
FRE:6313	134A WITH UV DYE..12 OZ CAN	\$ 7.87
FRE:134-30LB	SUVA 134A FREON..30 LB CYLINDER	\$ 146.69
FRE:134IMP ORT	IMPORT 134A FREON..30 LB CYLINDER	\$ 114.75

134A Fittings

FRE:S19322A	3/8" HIGH SIDE FITTING..5 PER PACK	\$ 13.70
-------------	------------------------------------	----------

Freeze 12 Fittings

FRE:S19020B	FREEZE 12 SERVICE LABELS..10 PER PACK	\$ 8.27
FRE:S19020A	FREEZE 12 SERVICE LABELS..50 PER PACK	\$ 39.96
FRE:S19000A	3/8" HIGH SIDE FITTING	\$ 12.60
FRE:S19001A	7/16" HIGH SIDE FITTING	\$ 3.99
FRE:S19002	7/16" LOW SIDE FITTING	\$ 2.99
FRE:S19013	7/16" 90 DEGREE HGHI SIDE FITTING..1 EACH	\$ 5.79
FRE:S19014	3/8" 90 DEGREE HIGH SIDE FITTING..1 EACH	\$ 5.79
FRE:S19016	7/16" 90 DEGREE LOW SIDE FITTING..1 EACH	\$ 5.79

Oils And Solvents

FRE:6001	FREEZE 12 OIL CHARGE..4 OZ CAN	\$ 4.99
FRE:OC-1	R 12 OIL CHARGE..4 OZ CAN	\$ 8.48
FRE:6002J	R12 / FREEZE 12 STOP LEAK .4 OZ CAN	\$ 5.65
FRE:6536	134A LEAK STOP WITH RED DYE..4 OZ CAN	\$ 3.34
FRE:6535	134A OIL CHARGE WITH UV DYE..12 OZ CAN	\$ 9.05
FRE:6416	PAG OIL CHARGE WITH UV DYE..4 OZ CAN	\$ 5.09
FRE:9145	134A UNIVERSAL PAG OIL CHANGER..1 EACH	\$ 5.15
FRE:6812	ISO 46 PAG OIL..12 OZ BOTTLE	\$ 8.65
FRE:6813	ISO 46 PAG OIL..32 OZ BOTTLE	\$ 13.85
FRE:6816	ISO 100 PAG OIL..8 OZ BOTTLE	\$ 4.33
FRE:6823	ISO 150 PAG OIL..32 OZ BOTTLE	\$ 18.06
FRE:6822	PAG OIL..12 OZ BOTTLE	\$ 6.89
FRE:6415	PAG OIL CHARGE..4 OZ CAN	\$ 5.55
FRE:6817	PAG OIL..32 OZ BOTTLE	\$ 16.24
FRE:2443	ESTER OIL WITH UV DYE..8 OZ BOTTLE	\$ 10.34
FRE:2445	ESTER OIL WITH UV DYE..32 OZ BOTTLE	\$ 32.25
FRE:6715	ESTER OIL CHARGE..4 OZ BOTTLE	\$ 3.15
FRE:6710	ISO 100 ESTER OIL..32 OZ BOTTLE	\$ 15.66
FRE:6710UV	ISO 100 ESTER OIL WITH UV DYE..32 OZ BOTTLE	\$ 23.18
FRE:6808	ISO 100 ESTER OIL..8 OZ BOTTLE	\$ 4.95
FRE:6708	ISO 100 ESTER OIL..12 OZ BOTTLE	\$ 4.22
FRE:6544	A/C FLUSH..1 GAL	\$ 16.87
FRE:6915	SERCON VACUUM PUMP OIL..32 OZ BOTTLE	\$ 4.08
FRE:6912	REFRIGERANT OIL..32 OZ BOTTLECH	\$ 4.14

A/C Tools and Adapters

FRE:8000	R12 EZ CAN TAPPER..1 EACH	\$ 9.99
FRE:6040	134A / R12 SIDE CAN TAP ..1 EACH	\$ 11.55
FRE:S19008A	7' R12 / FREEZE12 MANIFOLD HOSE KIT W/SHUTOFF VALVE..1 EACH	\$ 47.34
FRE:S19031	12 OZ CAN DISPENSING VALVE..1 EACH	\$ 11.05
FRE:90081	UNIV EZ CAN TAPPER WITH INSERTS..1 EACH	\$ 9.38
FRE:S19054	FREEZE 12 TO R12 ADAPTER..1 EACH	\$ 6.00
FRE:S19010A	FREEZE 12 CONVERSION KIT..5 FITTINGS	\$ 22.71



MONDAY-FRIDAY
8am-5pm a helpful
HUMAN voice will
always answer the
phone
(770)474-1286



FOR 50+ YEARS,
PARKER
BROTHERS
HAS BEEN
SERVING ATLANTA.
THANK YOU FOR
YOUR CONTINUED
SUPPORT!!



AUTO//INDUSTRIAL CHEMICALS

MISCELLANEOUS AUTOMOTIVE PRODUCTS

Air Tool Oil

MAR:085	AIR TOOL OIL..1 QT	\$ 7.10
P/B:16ATC	AIR TOOL CONDITIONER..12 OZ AEROSOL	\$ 6.29
P/B:16ETL	TOOL LIFE EXTENDER..12 OZ AEROSOL	\$ 4.64

Tune Up Grease

PER:22058	DIELECTRIC TUNE UP GREASE..3 OZ TUBE	\$ 6.98
-----------	--------------------------------------	---------

Belt Dressing

SSG:M 2-06	STOP SLIP BELT DRESSING..6 OZ AEROSOL	\$ 2.51
PER:80074	BELT DRESSING..6 OZ AEROSOL	\$ 2.43

Door and Lock Lubes

AGS:DE3	DOOR EASE STICK..3 OZ STICK	\$ 6.50
AGS:LE5	GRAPHITE LOCK EASE..3 OZ BOTTLE	\$ 4.13
AGS:M Z2	EXTRA FINE GRAPHITE MR. ZIP..21OZ TUBE	\$ 1.90

Head Light Restoration Kit

PER:09135	HEADLIGHT RESTORATION KIT	\$ 10.47
-----------	---------------------------	----------

Windshield Repair Kit

PER:16067	BULLSEYE WINDSHIELD REPAIR KIT...1 EACH	\$ 9.14
-----------	---	---------

Rust Inhibitors

PER:75448	RUST TREATMENT..1 GAL	\$ 56.75
LPS:00316	LPS#3 HEAVY DUTY RUST INHIBITOR..11 OZ AEROSOL	\$ 15.78
3M:08898	4 WAY LUBRICANT & PENETRANT..10.5 OZ. AEROSOL CAN	\$ 4.38
P/B:16CSP	CORROSIVE STOP GREASE..11 OZ AEROSOL	\$ 4.49

Rubber Coating

3M:08883	BLACK RUBBERIZED UNDERCOATING..19.75 OZ. AEROSOL CAN	\$ 10.88
3M:08864	BLACK BODY SCHUTZ RUBBERIZED COATING..32 OZ. CAN	\$ 22.11
3M:05917	WELD THRU II..12.75 OZ AEROSOL	\$ 19.88

Metal Working Compounds

PER:80036	VALVE GRINDING COMPOUND..1.5 OZ TUBE	\$ 2.64
PER:80038	PRUSSIAN BLUE...7.5 OZ TUBE	\$ 3.13

Windshield De-icer

SSG:DE-1	WINDSHIELD DE-ICER..12 OZ AEROSOL	\$ 2.09
PRI:AS242	DE-ICER WITH SCRAPER..12 OZ AEROSOL	\$ 2.91

Power Steering Sealer

LOP:10008	LUCAS POWER STEERING STOP LEAK..12 OZ BOTTLE	\$ 8.88
-----------	--	---------

Rear End Limited Slip Additive

L/G:31904	LIMITED SLIP SUPPLEMENT..4 OZ TUBE	\$ 6.69
-----------	------------------------------------	---------

Mass Air Flow System Cleaner

CRC:05110	MASS AIRFLOW SENSOR CLEANER..11OZ AEROSOL	\$ 6.80
-----------	---	---------

INDUSTRIAL CLEANERS AND DEGREASERS

Industrial Degreasers

LPS:720	INSTANT SUPER CLEANER..20 OZ AEROSOL	\$ 20.45
LPS:01420	PERSOLVE CLEANER DEGREASER..15 OZ AEROSOL	\$ 11.99
LPS:02705	CONCENTRATED PRECISION CLEAN CLEANER DEGREASER..5 GAL	\$ 133.64

ABC Conquest

Made from 100% natural, active, citrus products, this cleaner can be used for a variety of cleaning jobs. Diluted or undiluted, it does a wonderful job on tasks ranging from oven cleaner ,to ink remover, to laundry pre-spotter, to heavy duty degreaser.

ABC:CONQUEST-SPRAY	CONQUEST D-LIM ONENE DEGREASER AERSOL..20 OZ	\$ 3.75
ABC:CONQUEST-QT	CONQUEST D-LIM ONENE DEGREASER..1 QT	\$ 12.60
ABC:CONQUEST-1G	CONQUEST D-LIM ONENE DEGREASER..1 GAL	\$ 47.24
ABC:CONQUEST-P	CONQUEST D-LIM ONENE DEGREASER..5 GAL	\$ 275.55

Other Brands

CLN:D-LIM ONENE-P	D-LIM ONENE..5 GAL	\$ 232.94
CLN:D-LIM ONENE-D	D-LIM ONENE..55 GAL	\$ 1482.00
P/B:16CBD	CITRUS DEGREASER..12 OZ AEROSOL	\$ 6.78
SPR:15717	CITRUS DEGREASER..32 OZ PUMP BOTTLE	\$ 5.50



AUTO//INDUSTRIAL CHEMICALS



MISCELLANEOUS INDUSTRIAL PRODUCTS

Release Agent

LPS:02616	MR550 MOLD RELEASE & LUBRICANT..12 OZ AEROSOL	\$ 8.32
3M:08879	RELEASE AGENT..16 OZ. AEROSOL CAN	\$ 3.99

Kerosene

CLN:KEROSENE-D	K-1 KEROSENE ..55 GAL	\$ 389.15
----------------	-----------------------	-----------

Mineral Spirits

CLN:MIN-SPIRIT-P	MINERAL SPIRITS..5 GAL	\$ 70.11
CLN:MIN-SPIRIT-D	MINERAL SPIRITS..55 GAL	\$ 506.84
CLN:ODORLESS-D	ODORLESS MINERAL SPIRITS..55 GAL	\$ 577.32

Lacquer Thinner and Reducer

CLN:LACQ-THIN-P	#51 LACQUER THINNER..5 GAL	\$ 86.71
CLN:LACQ-THIN-D	#51 LACQUER THINNER..55 GAL	\$ 779.95
CLN:REDUCER33-D	#33 ACRYLIC ENAMEL REDUCER..55 GAL	\$ 330.26
CLN:NO-11	#11 LACQUER THINNER..55 GAL	\$ 342.43

Acetone

CLN:ACETONE-P	ACETONE..5 GAL	\$ 64.08
CLN:ACETONE-D	ACETONE..55 GAL	\$ 663.73

Caustic Soda

CLN:SODA-ASH	BICARBONATE SODA ASH..50 LB	\$ 29.25
CLN:CAUSTIC	CAUSTIC SODA BEADS..50 LB	\$ 49.17
CLN:CAUSTIC-400	CAUSTIC SODA FLAKES..400 LB	\$ 272.83

Alcohol

CLN:ALCOHOL-P	190 PROOF DENATURED ETHANOL..5 GAL	\$ 87.19
CLN:ALCOHOL-D	190 PROOF DENATURED ETHANOL..55 GAL	\$ 634.41
CLN:ETHANOL200-P	200 PROOF DENATURED ETHANOL 5 GAL	\$ 74.58
CLN:ETHANOL200-D	200 PROOF DENATURED ETHANOL..55 GAL	\$ 548.78
CLN:ISOPROPYL-P	99% ISOPROPYL ALCOHOL..5 GAL	\$ 69.29
CLN:ISOPROPYL-D	99% ISOPROPYL ALCOHOL..55 GAL	\$ 1032.34
CLN:METHANOL-P	METHANOL WOOD ALCOHOL..5 GAL	\$ 51.40
CLN:METHANOL-D	METHANOL WOOD ALCOHOL..55 GAL	\$ 421.94

Antifreeze Bases

CLN:ETHYL-GLY-D	ETHYLENE GLYCOL ..55 GAL	\$ 762.30
CLN:PROP-GLY-D	PROPYLENE GLYCOL..55 GAL	\$ 755.19
CLN:PROP-GLY-FGD	FOOD GRADE PROPYLENE GLYCOL..55 GAL	\$ 1,130.41

Toluene

CLN:TOLUENE-P	AROMATIC HYDRO CARBON FAMILY..5 GAL	\$ 103.17
CLN:TOLUENE-D	AROMATIC HYDRO CARBON FAMILY..55 GAL	\$ 695.02

Xylene

CLN:XYLENE-P	AROMATIC HYDRO CARBON FAMILY..5 GAL	\$ 86.94
CLN:XYLENE-D	AROMATIC HYDRO CARBON FAMILY..55 GAL	\$ 620.04

Specialty Products

CLN:111-TRI-P	111 TRICHLOROETHANE..5 GAL	\$ 117.36
CLN:MEK-P	METHYL ETHYL KETONE..5 GAL	\$ 119.75
CLN:MEK-D	METHYL ETHYL KETONE..55 GAL	\$ 810.52

Coil Cleaner

CLN:COIL-CLEAN	FOAMBRITE COIL CLEANER..1 GAL	\$ 8.20
----------------	-------------------------------	---------

FOR 50+ YEARS,
PARKER
BROTHERS
HAS BEEN
SERVING ATLANTA.
**THANK YOU FOR
YOUR CONTINUED
SUPPORT!!**

MONDAY-FRIDAY
8am-5pm a helpful
HUMAN voice will
always answer the
phone
(770)474-1286

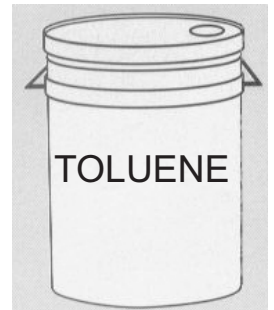

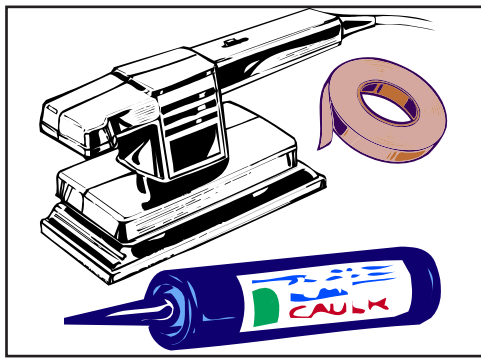

ADHESIVES & ABRASIVES

GASKET MAKERS AND SEALANTS
GASKET REMOVERS
THREADLOCKERS
PIPE AND THREAD SEALANTS
SPECIALIZED REPAIR
GLUES AND EPOXIES
AUTOMOTIVE ADHESIVES
ADHESIVE REMOVERS
DECAL REMOVERS
AUTOMOTIVE SEALERS
APPLICATOR GUNS
TAPE
PLASTIC WRAP
SAND PAPER
ABRASIVE ROLLS
GRINDING DISC
MISCELLANEOUS ABRASIVES
SCOTCH-BRITE PADS
SPECIALTY CLEANING AND STRIPPING DISC
CUT OFF WHEELS

ADHESIVES & ABRASIVES

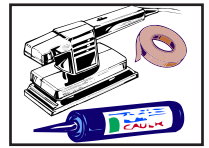

GASKET MAKERS & SEALANTS

Permatex The Right Stuff

This is the only product you will need for all your gasketing and sealant needs. This revolutionary formula is guaranteed not to leak. It resists shop fluids, protects against leaks due to vibration, and covers a wide temperature range

Permatex

PER:25229	1 MINUTE RIGHT STUFF GASKET MAKER..3OZ AEROSOL	\$ 9.81
PER:29208	RIGHT STUFF GASKET MAKER..5 OZ CARTRIDGE	\$ 15.43
PER:25223	RIGHT STUFF GASKET MAKER..4 OZ AUTOMATIC TUBE	\$ 16.96
PER:25224	RIGHT STUFF GASKET MAKER..7 OZ AUTOMATIC TUBE	\$ 18.64
PER:85224	THE RIGHT STUFF BLACK GASKET MAKER..7.5 OZ POWERBEAD CAN	\$ 21.70
PER:99070	THE RIGHT STUFF BLACK GASKET MAKER..2 - 5 OZ CARTRIDGES	\$ 26.76



Permatex Import The Right Stuff

The same reliable service as the original !! In addition Import The Right Stuff has been specially formulated for high torque loads caused by engines with closely spaced bolt patterns (typically found on import cars).

PER:34311	THE RIGHT STUFF GREY GASKET MAKER..5 OZ CARTRIDGE	\$ 15.48
PER:85144	THE RIGHT STUFF GREY GASKET MAKER..7.5 OZ POWERBEAD CAN	\$ 18.67
PER:99071	THE RIGHT STUFF GREY GASKET MAKER..2 - 5 OZ CARTRIDGES	\$ 24.96

Permatex Ultra Gasket Makers

Permatex Ultra silicones were developed to meet today's technology changes. These silicones are sensor-safe, low odor, non-corrosive, and have outstanding oil resistance, joint movement value, temperature range, and resistance to auto and shop fluids.

Per 598 Ultra Black - Fast-curing formula.

PER:82180	ULTRA BLACK GASKET MAKER..3.35 OZ TUBE	\$ 5.78
PER:40463	ULTRA BLACK GASKET MAKER..6.4 OZ POWERBEAD CAN	\$ 11.33
PER:24105	ULTRA BLACK GASKET MAKER..13 OZ CARTRIDGE	\$ 15.56
PER:85080	ULTRA BLACK GASKET MAKER..9.5 OZ POWERBEAD CAN	\$ 20.49
PER:82080	ULTRA BLACK GASKET MAKER..8.75 OZ AUTOMATIC TUBE	\$ 18.79

PER 82194 Ultra Gray - Designed for high torque applications.

PER:82194	ULTRA GREY GASKET MAKER..3.35 OZ TUBE	\$ 6.93
PER:82195	ULTRA GREY GASKET MAKER..13 OZ CARTRIDGE	\$ 12.63
PER:85084	ULTRA GREY GASKET MAKER..9.5 OZ POWERBEAD CAN	\$ 18.86

PER 77 Ultra Blue - General purpose

PER:81724	ULTRA BLUE RTV SILICONE GASKET MAKER..3.35 OZ TUBE	\$ 5.47
PER:81725	ULTRA BLUE RTV SILICONE GASKET MAKER..13 OZ CARTRIDGE	\$ 15.93
PER:85519	ULTRA BLUE RTV SILICONE GASKET MAKER..9.5 OZ POWERBEAD CAN	\$ 17.16

PER 101 Ultra Copper - The most advanced high temperature RTV silicone available.

PER:81878	ULTRA COPPER RTV SILICONE GASKET MAKER..3 OZ TUBE	\$ 5.50
PER:80697	COPPER HIGH TEMPERATURE SPRAY A GASKET..12 OZ AEROSOL	\$ 6.16
PER:85088	ULTRA COPPER RTV SILICONE GASKET MAKER..9.5 OZ POWERBEAD CAN	\$ 16.56



Other Brands

K/W:1504	COPPER COAT GASKET COMPOUND..4 OZ CAN	\$ 3.60
K/W:1612	COPPER COAT GASKET COMPOUND..11 OZ AEROSOL	\$ 4.78

Permatex Automatic Transmission RTV Sealant

This RTV sealant is designed to resist transmission fluid. It is a "form in place" gasket maker designed in conjunction with the major U.S. Auto makers.

PER:81180	AUTOMATIC TRANSMISSION RTV SEALANT..3 OZ TUBE	\$ 5.09
-----------	---	---------

Permatex Gasket Makers

These "form-in-place" gasket makers resist cracking, shrinking, and migrating. They also increase reliability of cut gaskets.

PER 6 Blue - Sensor safe and good up to 500F

PER:80022	SENSOR SAFE BLUE RTV SILICONE GASKET..3 OZ TUBE	\$ 4.20
PER:80628	SENSOR SAFE BLUE RTV SILICONE GASKET..11 OZ CARTRIDGE	\$ 12.79
PER:80023	SENSOR SAFE BLUE RTV SILICONE GASKET..12 OZ TUBE	\$ 13.60
PER:81860	SENSOR SAFE BLUE RTV SILICONE GASKET..7.25 AUTOMATIC TUBE	\$ 11.91

Other Brands

SSG:T5-03V	BLUE RTV SILICONE..3 OZ TUBE	\$ 2.01
------------	------------------------------	---------

PER 26 Hi Temp - Designed for heavy duty applications, this product stands up to temperatures of 650F.

PER:81160	RED HIGH TEMPERATURE RTV SILICONE GASKET..3 OZ TUBE	\$ 5.01
PER:81409	RED HIGH TEMPERATURE RTV SILICONE GASKET..11 OZ CARTRIDGE	\$ 13.02
PER:81915	RED HIGH TEMPERATURE RTV SILICONE GASKET..7.25 AUTOMATIC TUBE	\$ 13.79
PER:85915	RED HIGH TEMPERATURE RTV SILICONE GASKET..7.25 POWERBEAD CAN	\$ 18.18



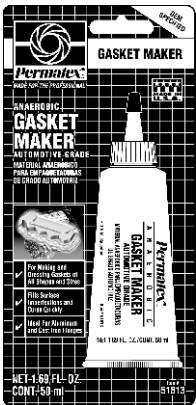
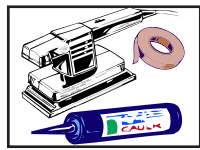

ADHESIVES & ABRASIVES

GASKET MAKERS & SEALANTS

PER 27 Hi Temp - Designed for heavy duty applications, this product stands up to temperatures of 650F plus is oxygen sensor safe.

PER:81422	HIGH TEMPERATURE RTV SILICONE GASKET..3 OZ TUBE	\$ 4.73
PER:81686	HIGH TEMPERATURE RTV SILICONE GASKET..11 OZ CARTRIDGE	\$ 14.30

Other Brands

SSG:T7-03V	RED HI TEMP RTV SILICONE..3 OZ TUBE	\$ 2.01
3M:08672	BLACK HI TEMP SILICONE GASKET..3 OZ. TUBE	\$ 7.26

3M Super Silicone Sealant

This rapid curing adhesive/sealant is formulated to solve repair and maintenance problems. It is an excellent "form-in-place" gasket and adheres to a wide variety of automotive surfaces.

3M:08661	CLEAR SUPER SILICONE SEALANT..3 OZ. TUBE	\$ 8.13
3M:08663	CLEAR SUPER SILICONE SEALANT..1/10 GAL CARTRIDGE GUN	\$ 12.15
3M:08664	BLACK SUPER SILICONE SEALANT..1/10 GAL CARTRIDGE GUN	\$ 12.15

Permatex Super 300 Form-A-Gasket

This non-hardening sealant is designed to resist heat transfer fluids such as oil or antifreeze (-65F-425F).

PER:80057	SUPER 300 FORM A GASKET SEALANT..4 OZ BOTTLE	\$ 3.81
-----------	--	---------

Permatex Form-A-Gasket #1

This fast drying, hard setting sealant is designed for sealing rigid materials and flanges, or patching holes and joints where permanent assembly is desired (-65F-400F).

PER:80008	FORM-A GASKET NO. 1 SEALANT..3 OZ TUBE	\$ 3.12
-----------	--	---------

Permatex Form-A-Gasket #2

This slow drying, non-hardening sealant is designed for sealing cut gaskets and stamped parts. It allows for easy disassembly (-65F-400F).

PER:80009	FORM-A GASKET NO. 2 SEALANT..1.5 OZ TUBE	\$ 2.26
PER:80016	FORM-A GASKET NO. 2 SEALANT..3 OZ TUBE	\$ 2.95
PER:80011	FORM-A GASKET NO. 2 SEALANT..11 OZ TUBE	\$ 6.86

Permatex Aviation Form-A-Gasket

This slow drying, non-hardening, brush top sealant is approved for use in aviation as well as automotive applications (-65F-400F).

PER:80019	AVIATION FORM A GASKET NO. 3 SEALANT..4 OZ BOTTLE	\$ 3.74
PER:80017	AVIATION FORM A GASKET NO. 3 SEALANT..16 OZ BOTTLE	\$ 7.92

Permatex Anaerobic Gasket Maker 518

This non-corrosive gasketing material is designed primarily for aluminum, iron, and steel flanged mating surfaces. It fills a gap of .015". It allows for easy disassembly and cures to a solvent resist seal that will not tear or decay during service.

PER:51817	ANAEROBIC GASKET MAKER..6 ML TUBE	\$ 3.13
PER:51813	ANAEROBIC GASKET MAKER PRI..50 ML TUBE	\$ 10.63

Permatex Anaerobic Gasket Maker 515

This flexible gasketing material is for use on rigid machine flanges with less than .015" gap. It flexes with flanges that move in service and eliminates performed gaskets.

PER:51531	ANAEROBIC FLANGE SEALANT..50 ML TUBE	\$ 19.70
-----------	--------------------------------------	----------

Permatex Tack & Seal Gasket Sealant

This non-hardening gasket sealant holds large gaskets in place during positioning and assembly, while allowing for easy disassembly.

PER:80938	TACK AND SEAL GASKET SEALANT..1.25 OZ TUBE	\$ 3.16
-----------	--	---------

Permatex Ultra Rubber Gasket Sealant and Dressing

This non-hardening gasket sealant and dressing is formulated specially for rubber gaskets. It conditions gaskets for longer life and seals potential leak paths. Oil and fluid resistant. (-65F - 400F).

PER:85409	RUBBER GASKET SEALANT AND DRESSING..1 OZ TUBE	\$ 3.31
-----------	---	---------

Permatex High Tack Gasket Sealant

This fast drying sealant dries to a highly tacky, non-brittle film. It is a reliable general adhesive.

PER:80063	HIGH TACK GASKET SEALANT..16 OZ CAN	\$ 9.32
PER:80065	HIGH TACK SPRAY A GASKET SEALANT..12 OZ AEROSOL	\$ 8.43

Permatex Gasket Shellac

This hard setting, economical sealant seals all common gasketing materials in low temperature and low pressure applications.

PER:80021	INDIAN HEAD GASKET SHELLAC COMPOUND..2 OZ BOTTLE	\$ 1.14
-----------	--	---------

ADHESIVES & ABRASIVES

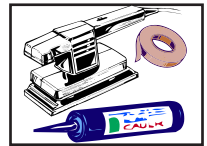

GASKET MAKERS & SEALANTS

Permatex Hylomar Flange Sealant

This exceptional high tack gel sealant is non-hardening and allows for easy disassembly of flanged components even after long term use.

PER:25249	GASKET DRESSING AND FLANGE SEALANT..1OZ TUBE	\$ 4.11
-----------	--	---------

GASKET REMOVERS

Permatex Aerosol Gasket Remover

This aerosol quickly removes even baked on gaskets and all types of gasketing adhesives and sealants. It also prepares the metal for new gasket.

PER:80646	GASKET REMOVER..16 OZ AEROSOL	\$ 9.90
-----------	-------------------------------	---------

Permatex Silicone Stripper Gel Gasket Remover

This OEM approved, patented gel easily removes silicone residue. Safe on plastic.

PER:80647	SILICONE STRIPPER GEL..2 OZ TUBE	\$ 21.41
-----------	----------------------------------	----------

3M Conditioning Discs

Used to quickly remove gaskets and gasketing material prior to assembly. They are ideal for cleaning light oxidation and removing gasketing residue.

3M:07453	2" CONDITIONING DISC COARSE..25 PER BAG	\$ 24.30
3M:07457	2" CONDITIONING DISC MEDIUM..25 PER BAG	\$ 18.44
3M:07508	2" MEDIUM ALUMINUM CONDITIONING DISC..25 PER BOX	\$ 20.87
3M:07705	2" MEDIUM CONDITIONING DISC..6 PER BOX	\$ 4.32
3M:07455	3" CONDITIONING DISC COARSE..25 PER BAG	\$ 46.50
3M:07456	3" CONDITIONING DISC MEDIUM..25 PER BAG	\$ 40.80
3M:07450	4" CONDITIONING DISC COARSE..10 PER BAG	\$ 20.87
3M:07451	4" CONDITIONING DISC MEDIUM..10 PER BAG	\$ 23.18
3M:07700	4" COURSE CONDITIONING DISC..6 PER BOX	\$ 12.08
3M:07701	4" MEDIUM CONDITIONING DISC..6 PER BOX	\$ 10.61

3M Conditioning Disc Holder

3M:07494	2" CONDITIONING DISC HOLDER..1 EACH	\$ 3.80
3M:07493	3" CONDITIONING DISC HOLDER..1 EACH	\$ 5.18
3M:07492	4" CONDITIONING DISC HOLDER..1 EACH	\$ 6.33

3M Roloc Conditioning Disc

The same great performance of 3M conditioning disc with the added security of the Roloc fastening system.

3M:07480	2" COARSE ROLOC CONDITIONING DISC..25 PER BOX	\$ 29.40
3M:07481	2" MEDIUM ROLOC CONDITIONING DISC..25 PER BOX	\$ 28.89
3M:07515	2" MEDIUM ALUMINUM ROLOC CONDITIONING DISC..25 PER BOX	\$ 29.74
3M:07516	2" MEDIUM ALUMINUM ROLOC CONDITIONING DISC..25 PER BOX	\$ 26.55
3M:07485	3" COARSE ROLOC CONDITIONING DISC..25 PER BOX	\$ 55.61
3M:07486	3" MEDIUM ROLOC CONDITIONING DISC..25 PER BOX	\$ 54.15
3M:07513	3" MEDIUM ALUMINUM ROLOC CONDITIONING DISC..25 PER BOX	\$ 55.61
3M:07514	3" FINE ALUMINUM ROLOC CONDITIONING DISC..25 PER BOX	\$ 49.67
3M:07482	4" COARSE ROLOC CONDITIONING DISC..10 PER BOX	\$ 26.69
3M:07483	4" MEDIUM ROLOC CONDITIONING DISC..10 PER BOX	\$ 26.69

3M Roloc Bristle Disc

These super tough plastic bristle brushes are embedded with abrasives and wear as they clean, continually exposing fresh abrasives. They are the ideal tool to replace scrapers, wire wheels and chemical gasket strippers

3M:07524	2" 50 GRIT ROLOC BRISTLE DISCS..10 PER BOX	\$ 71.34
3M:07525	2" 80 GRIT ROLOC BRISTLE DISCS..10 PER BOX	\$ 69.46
3M:07526	3" 50 GRIT ROLOC BRISTLE DISCS..10 PER BOX	\$ 98.43
3M:07527	3" 80 GRIT ROLOC BRISTLE DISCS..10 PER BOX	\$ 102.86
3M:07529	3" 120 GRIT ROLOC BRISTLE DISCS..10 PER BOX	\$ 98.43

3M Roloc Disc Holder

3M:05539	2" ROLOC DISC PAD ASSEMBLY..1 EACH	\$ 17.42
3M:05540	3" ROLOC DISC PAD ASSEMBLY..1 EACH	\$ 23.03
3M:05541	4" ROLOC DISC PAD ASSEMBLY..1 EACH	\$ 18.59

THREADLOCKERS

Permatex Purple Low Strength Threadlocker

This threadlocker is designed for precision aluminum fasteners under ¼ inch (6mm) that require occasional adjustments.

PER:22200	LOW STRENGTH PURPLE THREADLOCKER..10 ML BOTTLE	\$ 8.27
-----------	--	---------



FOR 50+ YEARS,
PARKER
BROTHERS
HAS BEEN
SERVING ATLANTA.
THANK YOU FOR
YOUR CONTINUED
SUPPORT!!

Permatex®



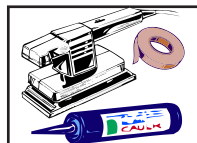

ADHESIVES & ABRASIVES

THREADLOCKERS

Permatex Blue Removable Strength Threadlocker

This all purpose threadlocker is ideal for preventing all nuts and bolts from loosening due to vibration. It eliminates the need to stock expensive lock washers and lock nuts.

PER:24005	MEDIUM STRENGTH BLUE GEL THREADLOCKER..5 G TUBE	\$ 5.94
PER:24010	MEDIUM STRENGTH BLUE GEL THREADLOCKER..10 G TUBE	\$ 14.45
PER:24206	MEDIUM STRENGTH BLUE THREADLOCKER..2.5 ML TUBE	\$ 2.44
PER:24200	MEDIUM STRENGTH BLUE THREADLOCKER..6 ML TUBE	\$ 6.08
PER:24240	MEDIUM STRENGTH BLUE THREADLOCKER..36 ML TUBE	\$ 26.34

Permatex Blue Medium Strength Threadlocker

This threadlocker is especially well suited for fasteners between ¼ inch and 1 inch (6mm to 25mm) that have been coated with DRI-LOC adhesive. It is oil resistant and prevents loosening due to vibration.

PER:24300	SURFACE INSENSITIVE THREADLOCKER..10 ML BOTTLE	\$ 10.19
-----------	--	----------

Other Brands

PRI:24250	MEDIUM STRENGTH BLUE THREADLOCKER..50 ML TUBE	\$ 10.45
-----------	---	----------

Permatex Red Hi- Strength Threadlocker

This threadlocker is designed for heavy-duty applications. It is especially well suited for permanently locking studs and press fits. It adds 3000 PSI holding power, and replaces set screws and snap rings. It requires extra effort or a special tool for removal.

PER:27005	HIGH STRENGTH RED GEL THREADLOCKER..5 G TUBE	\$ 10.39
PER:27010	HIGH STRENGTH RED GEL THREADLOCKER..10 G TUBE	\$ 11.43
PER:27100	HIGH STRENGTH RED THREADLOCKER..6 ML TUBE	\$ 5.85
PER:27140	HIGH STRENGTH RED THREADLOCKER..36 ML TUBE	\$ 22.00

Other Brands

PRI:27150	HIGH STRENGTH RED THREADLOCKER..50 ML TUBE	\$ 10.99
-----------	--	----------

Permatex Red Hi-Temp/Hi- Strength Threadlocker

This threadlocker is designed for heavy-duty applications. It prevents nuts and bolts from loosening due to shock, severe vibration, or heat stress. It is removable with heat and hand tools.

PER:27200	HIGH TEMPERATURE RED THREADLOCKER..10 ML TUBE	\$ 9.01
PER:27240	HIGH TEMPERATURE RED THREADLOCKER..36 ML TUBE	\$ 28.43

Permatex Green Wicking Threadlocker

This threadlocker is designed to be used on pre-assembled parts. It's unique low viscosity formula wicks along the threads securing them in place. Localized heating and hand tools are required for removal.

PER:29000	PENETRATING GREEN THREADLOCKER..6 ML TUBE	\$ 5.44
PER:29040	PENETRATING GREEN THREADLOCKER..36 ML TUBE	\$ 22.14

Permatex Bearing Mounts For Relaxed Fits

This high strength, anaerobic adhesive secures slip fit assemblies. In 10 minutes, it provides 4000 PSI shear strength on steel. Replaces set screws, clamp rings, snap rings, wheel bearings, idler shafts, and press fit bearings.

PER:68040	BEARING MOUNT FOR RELAXED FIT..36 ML TUBE	\$ 26.75
-----------	---	----------

Permatex Sleeve Retainer

This high strength, anaerobic adhesive secures slip and press fit assemblies. It adds 3000 PSI of holding power. Special tools required for removal.

PER:64000	HIGH TEMPERATURE SLEEVE RETAINER..6 ML TUBE	\$ 6.25
PER:64040	HIGH TEMPERATURE SLEEVE RETAINER..36 ML TUBE	\$ 26.75

Permatex Klean'N Prime Primer

This cleaning solvent is designed to prepare parts for the use of Permatex Threadlockers. It increase threadlocker strength and speeds curing time by 50%. It is recommended for use during cold weather.

PER:24163	KLEAN-N-PRIME ACTIVATOR..6 OZ AEROSOL	\$ 13.99
-----------	---------------------------------------	----------

PIPE AND THREAD SEALANT

Permatex Pipe Sealant w/ Teflon

Industrial Grade - It is formulated specifically for metal, tapered pipe thread fittings. It replaces Teflon tape, cures rapidly, and can withstand 10,000 PSI.

PER:56521	THREAD SEALANT..50 ML TUBE	\$ 10.34
-----------	----------------------------	----------

High Performance - This sealant lubricates threads for easy assembly and disassembly. It resists leakage, vibration loosening, moisture, hydraulic fluids and diesel fuels.

PER:59235	HIGH TEMPERATURE THREAD SEALANT..50 ML TUBE	\$ 9.79
-----------	---	---------

Permatex Pipe Joint Compound

PER:80045	PIPE JOINT COMPOUND..16 OZ BOTTLE	\$ 6.94
-----------	-----------------------------------	---------

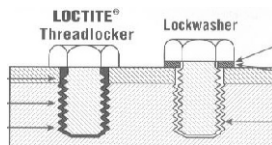

Permatex[®]

MONDAY-FRIDAY
8am-5pm a helpful
HUMAN voice will
always answer the
phone
(770)474-1286

(770)474-1286

ADHESIVES & ABRASIVES

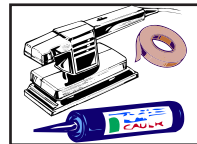

PIPE AND THREAD SEALANT

Permatex Thread Sealant w/ Teflon

This economical general purpose fitting sealant outperforms tapes and pipe dope. It seals and resists pressure in air, oils, diesel fuels, and hydraulic fluids.

PER:80631	THREAD SEALANT WITH TEFLON ..1 OZ TUBE	\$ 3.27
PER:80632	THREAD SEALANT WITH TEFLON..4 OZ CAN	\$ 5.89
PER:80633	THREAD SEALANT WITH TEFLON..16 OZ CAN	\$ 10.83

Teflon Tape

TAP:1442	1/2" X 520" TEFLON TAPE	\$ 1.06
----------	-------------------------	---------

SPECIALIZED REPAIR

Permatex Muffler Bandage and Sealer

Muffler bandages are epoxy impregnated fiberglass which chemically weld mufflers and tailpipes. It saves costly parts replacement by repairing holes and leaks in exhaust systems.

PER:80332	MUFFLER TAILPIPE BANDAGE..120 SQ IN BANDAGE	\$ 2.40
-----------	---	---------

Muffler sealer seals holes and leaks around joints. It also makes installation more secure.

PER:80335	MUFFLER TAILPIPE SEALER..3 OZ TUBE	\$ 1.56
-----------	------------------------------------	---------

Permatex Instant Gas Tank Repair

Instantly seals small gas tank holes without tank removal. This permanent, easy to use, two part epoxy ribbon dries to a hard seal in 60 minutes. It ven sticks to "gasoline wet" metal.

PER:12020	INSTANT GAS TANK REPAIR..1 EACH	\$ 4.27
PER:09101	FUEL TANK REPAIR KIT	\$ 6.89

Permatex Form-a-Thread

This unique product allows for the repair of worn, stripped, or damaged threads without the need for drills, taps, tools, or inserts. It is effective up to 128ft.lbs of torque, and it helps eliminate future corrosion, galling, seizing, and rust.

PER:81668	STRIPPED THREAD REPAIR...44 OZ KIT	\$ 8.48
-----------	------------------------------------	---------

Permatex Form-a-Seal

This product provides a quick, easy solution for those annoying little leaks. Without removing any parts, clean the leaking area and spray a durable rubber barrier that will resist common shop fluids.

PER:82096	FORM A SEAL LEAK REPAIR..6 OZ AEROSOL	\$ 6.41
PER:82099	FORM A SEAL LEAK REPAIR..12 OZ AEROSOL	\$ 5.55

LPS Metal Repair

These products plug leaks and fill gaps in many products. They harden like metal and can be machined, drilled, and painted.

LPS:60159	STRONG STEEL RENEWAL COMPOSITE..4 OZ STICK	\$ 12.95
-----------	--	----------

GLUES AND EPOXIES

Permatex Super Bonder

This instant adhesive is for general purpose bonding of metals, alloys, rubbers, etc.

PER:49450	PERMATEX SUPER GLUE..1 OZ BOTTLE	\$ 12.49
-----------	----------------------------------	----------

Other Brands

PER:01810	SUPER GLUE..2 G TUBE	\$ 1.43
PER:82190	SUPER GLUE..2 G TUBE	\$ 1.51
PER:82191	SUPER GLUE QUICK GEL..2 G TUBE	\$ 1.70
PER:21309	ULTRA BOND SUPER GLUE..5 G BOTTLE	\$ 2.14

Permatex Cold Weld

A 15 minute, 2 part adhesive and filler system that will eliminate the need for welding or brazing. Once cured it can be drilled, sanded, painted, or filed. It resists most automotive and shop fluids

PER:14600	COLD WELD BONDING COMPOUND..2-1 OZ TUBE	\$ 4.12
-----------	---	---------

Permatex Fast Cure Epoxy

This convenient, pre-measured epoxy is ideal for bonding glass, hard plastics, rubber, and metal. It bonds in 5 to 15 minutes with no mess, no guess work, and no waste.

PER:21425	FAST CURE EPOXY..10 / 4 G CUPS	\$ 15.78
-----------	--------------------------------	----------

Other Brands

PER:82516	1 MINUTE EPOXY 2 PART EPOXY	\$ 2.89
PER:82517	5 MINUTE EPOXY 2 PART EPOXY	\$ 2.94
PER:84101	5 MINUTE GENERAL PURPOSE EPOXY...84 OZ DUAL SYRINGE	\$ 2.91
PER:84115	PER 5 MINUTE PLASTIC WELD...8.4 DUAL SYRINGE	\$ 3.93
PER:84209	4 MINUTE MULTI-METAL EPOXY..2 - 1 OZ TUBES	\$ 4.22



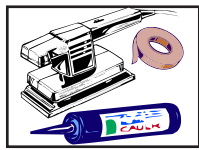

ADHESIVES & ABRASIVES

GLUES AND EPOXIES

Permatex®



Other Brands

JBW:8212S	MINI DUAL SYRINGE EPOXY	\$ 2.49
JBW:8265-S	2 PART COLD WELD COMPOUND DISPLAY BOX..1 SET	\$ 4.21
JBW:8265-TT	2 PART COLD WELD COMPOUND DISPLAY BOX..6 SETS	\$ 3.75
JBW:8267-S	COLD WELD COMPOSITE..2 OZ STICK	\$ 4.15
JBW:8276	2 PART KWIK WELD COMPOUND..1 SET	\$ 4.33
JBW:8277	WATERWELD..2 OZ STICK	\$ 5.49
JBW:8272	2 PART MARINE WELD..1 SET	\$ 4.43

AUTOMOTIVE ADHESIVES

3M Super Weatherstrip Adhesive

This adhesive bonds all types of gaskets to painted or unpainted metal surfaces. It is easy to brush and spread, extremely fast-drying, waterproof, flexible, and has exceptional bonding strength

3M :08001	YELLOW WEATHERSTRIP ADHESIVE..5 OZ. TUBE	\$ 7.10
3M :08008	BLACK WEATHERSTRIP ADHESIVE..5 OZ. TUBE	\$ 8.57
3M :08011	BLACK WEATHERSTRIP ADHESIVE..5 OZ. TUBE	\$ 7.76

Other Brands

SSG:T 14-05	TITISEAL WEATHERSTRIP ADHESIVE..5 OZ TUBE	\$ 1.76
-------------	---	---------

Permatex Contact Cement

It make a tough, permanent bond. Bonds to metal, wood, ceramic, leather, rubber and many other surfaces Heat and water resistant.

PER:25905	CONTACT CEMENT..1.5 OZ TUBE	\$ 2.02
-----------	-----------------------------	---------

Permatex Rearview Mirror Adhesive

Approved and used by GM, Ford, and Chrysler, rearview mirror adhesive permanently remounts mirrors to windshields.

PER:81844	REAR VIEW MIRROR ADHESIVE..2 PART KIT	\$ 2.32
-----------	---------------------------------------	---------

3M Trim Adhesives

General trim adhesive is for bonding automotive materials (carpeting, jute pads, fabrics, and plastics) to metal and other surfaces. It has excellent heat and water resistance.

3M :08088	CLEAR GENERAL TRIM ADHESIVE..16.25 OZ. AEROSOL CAN	\$ 15.02
3M :08031	AMBER FAST TACK TRIM ADHESIVE..5 OZ. TUBE	\$ 8.19
3M :08074	CLEAR SPRAY TRIM ADHESIVE..24 OZ. CAN	\$ 12.03

Other Brands

PER:82019	ALL PURPOSE SPRAY ADHESIVE..16 OZ AEROSOL	\$ 5.86
-----------	---	---------

3M Super Trim Adhesive

This contact adhesive is designed for bonding vinyl tops, heavyweight headliners, and hood silencer pads where high strength and heat resistance are needed.

3M :08090	YELLOW SUPER TRIM ADHESIVE..18 OZ. AEROSOL CAN	\$ 22.27
-----------	--	----------

3M Spray Disc Adhesive

A transparent, instant tack adhesive for bonding automotive feathering discs.

3M :08054	SPRAY DISC ADHESIVE..6 OZ. CAN	\$ 9.56
-----------	--------------------------------	---------

3M Emblem and Plastic Adhesive

An excellent clear adhesive for plastic repair and emblem application. It may be used for interior and exterior bonding.

3M :08061	CLEAR PLASTIC AND EMBLEM ADHESIVE..5 OZ. TUBE	\$ 8.18
-----------	---	---------

3M Structure Adhesive

A 2-part, general purpose, gray structural adhesive that may be used for bonding metal, glass, and plastic.

3M :08101	STRUCTURAL ADHESIVE KIT..2 PART - 2 OZ. EACH..1 KIT	\$ 20.52
-----------	---	----------

ADHESIVE REMOVER

3M Adhesive Remover

This fast acting remover is used to remove adhesive residue from all acrylic enamel painted metal surfaces

3M :08908	ADHESIVE REM OVER..24 OZ. AEROSOL CAN	\$ 25.82
-----------	---------------------------------------	----------

3M General Purpose Adhesive Remover

This specially blended solvent blend provides quick east clean up of most adhesives. It also removes waxes, road tar, grease, oil and other similar products.

3M :08984	GENERAL PURPOSE ADHESIVE CLEANER..1QT. CAN	\$ 15.87
-----------	--	----------

3M Release Agent

This special solvent blend works quickly to soften bond between auto glass and rubber grommets, as well as between metal and weatherstripping

3M :08879	RELEASE AGENT..16 OZ. AEROSOL CAN	\$ 3.99
-----------	-----------------------------------	---------

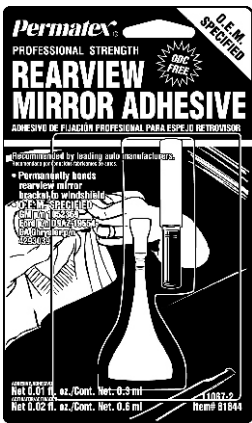

ADHESIVES & ABRASIVES

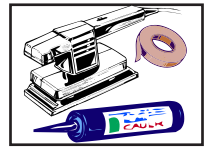

DECAL REMOVER

3M Adhesive And Stripe Removal Disc

These discs are designed to remove decals, graphics, and stripping tape from acrylic enamel and urethane paints

3M:07501	4" X 3/8" MOLDING ADHESIVE/STRIPE REMOVAL DISC..10 PER BAG	\$ 15.00
3M:07502	6" X 3/8" MOLDING ADHESIVE/STRIPE REMOVAL DISC..10 PER BAG	\$ 19.58
3M:07517	8" X 5/8" STRIPE REMOVAL DISC..1 EACH	\$ 70.40
3M:07500	ROLOC HOLDER..1 EACH	\$ 12.06
3M:07519	STRIPE REMOVAL ADAPTOR..1 EACH	\$ 7.08

3M Stripe Remover

Quickly removes stripes from acrylic enamel surfaces.

3M:08907	WOODGRAIN & STRIPE REMOVER..24 OZ. AEROSOL CAN	\$ 25.08
----------	--	----------

Permatex Decal and Paint Stripper

Quickly strips and removes decals and paint from bumpers and truck bodies.

PER:80577	DECAL AND PAINT STRIPPER..16 OZ AEROSOL	\$ 7.10
-----------	---	---------

Permatex®



AUTOMOTIVE SEALERS

3M Heavy Drip-Check Sealer

Heavy Drip-Check Sealer is designed for use on vertical seams. It has a heavier bodied consistency which allows for a 1/8" bead to be applied easily. It has excellent adhesion to glass, metal, rubber, etc. It also resists gas and oil.

3M:08531	GREY HEAVY DRIP-CHECK SEALER..5 OZ. TUBE	\$ 11.28
----------	--	----------

Permatex Multi-Purpose Silicone Trailer Repair

This multi-purpose silicone repairs leaky trailer with a durable, paintable seal.

PER:31339	WHITE SILICONIZED MULTI-PURPOSE SEALANT..11 OZ CARTRIDGE	\$ 2.99
PER:31340	ALMOND SILICONIZED MULTI-PURPOSE SEALANT..11 OZ CARTRIDGE	\$ 2.99
PER:31341	CLEAR SILICONIZED MULTI-PURPOSE SEALANT..11 OZ CARTRIDGE	\$ 2.99



Permatex Silicone Adhesive Sealant

This general purpose indoor/outdoor sealant seals, bonds, repairs, mends and secures glass, metal, plastic, fabric, vinyl and weatherstripping. It also protects and repairs electrical wiring.

PER:81158	BLACK SILICONE ADHESIVE SEALANT..3 OZ TUBE	\$ 3.91
PER:81173	BLACK SILICONE ADHESIVE SEALANT..11 OZ CARTRIDGE	\$ 12.26
PER:80050	CLEAR RTV SILICONE ADHESIVE SEALANT..3 OZ TUBE	\$ 3.82
PER:80855	CLEAR RTV SILICONE ADHESIVE SEALANT..11 OZ CARTRIDGE	\$ 12.92
PER:85913	CLEAR RTV SILICONE ADHESIVE SEALANT..7.25 OZ POWERBEAD CAN	\$ 14.17
PER:81913	CLEAR RTV SILICONE ADHESIVE SEALANT..7.25 OZ AUTOMATIC TUBE	\$ 13.36



Other Brands

PRI:80046	BLACK SILICONE ADHESIVE SEALANT..3 OZ TUBE	\$ 1.65
-----------	--	---------

3M Auto Sealer

This sealer is used to seal windshields, backlites, truck ornaments, taillights, and other small seams on the auto body. It is clear, flexible, and will not harden or become brittle

3M:08551	CLEAR AUTO SEALER..5 OZ. TUBE	\$ 10.17
3M:08302	CLEAR ULTRAPRO AUTOBODY SEALANT..5 OZ. TUBE	\$ 13.05

3M Strip Caulk

These 1ft caulking strips are for use in all types of seams, joints, and openings. They adhere to metal, paint, rubber, and glass. After being thumbed into place and smoothed with a finger, they are ready for painting.

3M:08578	1" BLACK STRIP CAULK..60 PER BOX	\$ 18.28
----------	----------------------------------	----------

3M Urethane Adhesive/Sealer

This rapid curing adhesive/sealant is designed for use on all flush mounted and bonded windshields and backlites. It is black, odorless, and easily applied.

3M:08609	BLACK WINDO-WELD SUPER FAST URETHANE..10 OZ. CARTRIDGE	\$ 21.51
----------	--	----------

3M Windo-Weld Resealant

This flow grade sealant was designed to stop leaks by easily flowing into pin holes on gasketless windshields and backlites. It dries fast into a flexible, rubbery seal. It adheres to glass and metal.

3M:08633	BLACK WINDO-WELD RESEALANT..1 PINT CAN	\$ 14.84
3M:08634	BLACK WINDO-WELD RESEALANT..10.3 OZ CARTRIDGE	\$ 10.95

3M Windo-Weld Sealer Black

This one part polysulfide adhesive sealant was designed for use in replacement of bonded windshields and backlites. It is ideal for providing a supplementary seal for windshields installed with butyl tape. Requires no primire

3M:08606	BLACK WINDO-WELD SEALER..10.3 OZ CARTRIDGE	\$ 22.82
----------	--	----------



FOR 50+ YEARS,
PARKER
BROTHERS
HAS BEEN
SERVING ATLANTA.
THANK YOU FOR
YOUR CONTINUED
SUPPORT!!

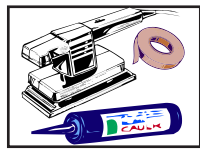

ADHESIVES & ABRASIVES

APPLICATOR GUNS

3M Cartridge Applicator Gun

For use on 3M .1 gallon cartridges

3M :08992	1/10 GALLON CARTRIDGE GUN..1 EACH	\$ 9.45
-----------	-----------------------------------	---------

3M Applicator Gun

For use with 3M automotive sealers and adhesives, it comes with two tips : windshield tip and all purpose tip.

3M :08994	ADHESIVE / SEALANT APPLICATOR GUN..1 EACH	\$ 31.13
-----------	---	----------

3M Mixing Nozzle

For use with 3M Atomix Heavy Duty 2oz applicator gun.

3M :08197	CLEAR MIXING NOZZLES-CLEAR..6 PER BAG	\$ 6.99
-----------	---------------------------------------	---------

3M Body Schutz Applicator Gun

For use with 3M rubberized Body Schutz Coating and Rocker Schutz.

3M :08997	BODY SCHUTZ APPLICATOR GUN..1 EACH	\$ 88.47
-----------	------------------------------------	----------



TAPE

Box Sealing Tape

3M :91764	48M M X 50 METERS CLEAR BOX SEALING TAPE..1 ROLL	\$ 5.23
3M :06642	48MM X 50 METERS TAN BOX SEALING TAPE..1 ROLL	\$ 4.71
TAP :6100-CLR	2" X 110 YD CLEAR CARTON SEALING TAPE	\$ 2.57
TAP :6100-TAN	2" X 110 YD TAN CARTON SEALING TAPE	\$ 1.50

Tape Guns

3M :06927	ATG 752 TAPE DISPENSER..1 EACH	\$ 41.15
TAP :H60	2" TAPE DISPENSER	\$ 7.99

Masking Tape

3M :26332	12M M X 55M GREEN MASKING TAPE..1 ROLL	\$ 3.18
3M :26334	18M M X 55M GREEN MASKING TAPE..1 ROLL	\$ 3.92
3M :26338	36MM X 55M GREEN MASKING TAPE..1 ROLL	\$ 7.63
3M :26340	48MM X 55M GREEN MASKING TAPE..1 ROLL	\$ 11.32
3M :06334	3/4" X 60 YARDS REFINISH MASKING TAPE..1 ROLL	\$ 3.92
3M :06338	1 1/2" X 60 YARDS REFINISH MASKING TAPE..1 ROLL	\$ 6.95
3M :06340	2" X 60 YARDS REFINISH MASKING TAPE..1 ROLL	\$ 11.72
TAP :1121-60	3/4" X 60 YD M MASKING TAPE	\$ 1.17
TAP :1122-60	1" X 60 YD MASKING TAPE	\$ 1.05
TAP :1124-60	2" X 60 YD MASKING TAPE	\$ 3.06

Electrical Tape

3M :06132	3/4" X 66" SUPER 33 ELECTRICAL TAPE..1 ROLL	\$ 4.86
3M :06133	3/4" X 52" SUPER 33 ELECTRICAL TAPE..1 ROLL	\$ 4.19
3M :06143	3/4" X 66" SUPER 88 ELECTRICAL TAPE..1 ROLL	\$ 5.49
3M :49656	3/4" X 60" TARTAN ELECTRICAL TAPE..1 ROLL	\$ 0.96
TAP :20122	3/4" X 60' ELECTRICAL TAPE	\$ 0.70

Duct Tape

3M :06975	2" X 60 YARDS SILVER DUCT TAPE..1 ROLL	\$ 10.78
TAP :155-SP	2" X 60 YD DUCT TAPE	\$ 5.53
TAP :DUCT-TAPE-B	2" X 60 YD BLACK DUCT TAPE	\$ 7.33

Filament Tape

3M :06897	18MM X 55 METERS SCOTCH FILAMENT TAPE..1 ROLL	\$ 10.07
3M :06898	24MM X 55 METERS SCOTCH FILAMENT TAPE..1 ROLL	\$ 8.33
TAP :1220	1/2" X 60 YD FILAMENT TAPE	\$ 0.92
TAP :1221	18 MM X 55 MM FILAMENT TAPE	\$ 1.41
TAP :1222	1" X 60 YD FILAMENT TAPE	\$ 1.86
TAP :1224-788	2" X 60 YD FILAMENT TAPE	\$ 3.77

Double Sided Tape

3M :65603	2" X 36 YDS. DOUBLE COATED PAPER TAPE..1 ROLL	\$ 22.19
-----------	---	----------

Foam Tape

3M :06380	1/2" X 20 YARDS WHITE DOUBLE COATED FOAM TAPE..1 ROLL	\$ 44.91
3M :06383	7/8" X 20 YARDS GREY DOUBLE COATED FOAM TAPE..1 ROLL	\$ 63.31
3M :06370	3/4" X 18 YARDS BLACK VINYL FOAM TAPE	\$ 34.22



ADHESIVES & ABRASIVES

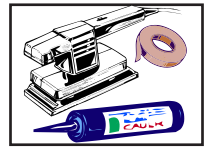

TAPE

Velcro Strips

3M :06481	1" X 4.9 YARD HOOK AND LOOP FASTENING SYSTEM ..1 ROLL	\$ 44.09
-----------	---	----------

Automotive Attachment Tape

3M :03609	1/2" X 60" AUTOMOTIVE ATTACHMENT TAPE..1 ROLL	\$ 3.92
-----------	---	---------

PLASTIC WRAP

Shrink Wrap

TAP :70GA -18X1850	70 GAUGE SHRINK WRAP..4 ROLLS / 18" X 1850'	\$ 61.17
TAP :80GA -3X1000	80 GAUGE SHRINK WRAP..18 ROLLS / 3" X 1000'	\$ 59.10
TAP :80GA -5X1500	80 GAUGE SHRINK WRAP..4 ROLLS / 5" X 1500'	\$ 54.75
TAP :80GA -12X1500	80 GAUGE SHRINK WRAP..4 ROLLS / 12" X 1500'	\$ 37.89
TAP :80GA -15X1500	80 GAUGE SHRINK WRAP..4 ROLLS / 15" X 1500'	\$ 59.61
TAP :80GA -18X1500	80 GAUGE SHRINK WRAP..4 ROLLS / 18" X 1500'	\$ 62.16
TAP :80GA -18X1500BLK	80 GAUGE BLACK SHRINK WRAP..4 ROLLS / 18" X 1500'	\$ 86.61
TAP :80GA -20X1000	80 GAUGE SHRINK WRAP..4 ROLLS / 20" X 1000'	\$ 76.95
TAP :90GA -15X1500	90 GAUGE SHRINK WRAP..4 ROLLS / 15" X 1500'	\$ 74.87
TAP :90GA -18X1500	90 GAUGE SHRINK WRAP..4 ROLLS / 18" X 1500'	\$ 73.72

Shrink Wrap Dispenser

TAP :12-18	SHRINK WRAP DISPENSER	\$ 53.22
------------	-----------------------	----------

SAND PAPER

3M Elek-Tro-Cut Cloth Sheets

This abrasive is designed for metal sanding, deburring, and quick clean ups by hand.

3M :02406	9"X11" ELEK-TRO-CUT CLOTH SHEETS 180 GRIT..50 SHEETS PER SLEEVE	\$ 80.54
3M :02407	9"X11" ELEK-TRO-CUT CLOTH SHEETS 150 GRIT..50 SHEETS PER SLEEVE	\$ 80.54

Other Brands

M IR :21-104-180	9" X 11" 180 GRIT FINISHING SHEET..50 SHEETS PER PACK	\$ 34.95
M IR :21-104-220	9" X 11" 220 GRIT FINISHING SHEET..50 SHEETS PER PACK	\$ 32.04
M IR :21-104-320	9" X 11" 320 GRIT FINISHING SHEET..50 SHEETS PER PACK	\$ 32.04
M IR :21-104-500	9" X 11" 500 GRIT FINISHING SHEET..50 SHEETS PER PACK	\$ 31.84

File Paper

M IR :23-364-080	2 3/4" X 16 1/2" 80 GRIT FILE PAPER..50 PER BOX	\$ 27.66
M IR :23-170-080	2 3/4" X 17 1/2" 80 GRIT FILE PAPER..50 PER BOX	\$ 21.87
M IR :23-170-036	2 3/4" X 17 1/2" 36 GRIT FILE PAPER..50 PER BOX	\$ 34.90

Dual Action Sander Paper

M IR :23-314-120	5" 120 GRIT SANDING DISC..100 PER BOX	\$ 27.80
M IR :23-341-036	6" 36 GRIT SANDING DISC..50 PER BOX	\$ 69.67
M IR :23-341-040	6" 40 GRIT SANDING DISC..50 PER BOX	\$ 72.45
M IR :23-342-080	6" 80 GRIT SANDING DISC..100 PER BOX	\$ 47.70
M IR :23-342-100	6" 100 GRIT SANDING DISC..100 PER BOX	\$ 42.34
M IR :23-342-120	6" 120 GRIT SANDING DISC..100 PER BOX	\$ 42.34
M IR :23-342-180	6" 180 GRIT SANDING DISC..100 PER BOX	\$ 46.75
M IR :23-342-220	6" 220 GRIT SANDING DISC..100 PER BOX	\$ 37.62
M IR :23-342-320	6" 320 GRIT SANDING DISC..100 PER BOX	\$ 42.49
M IR :23-622-320	6" 320 GRIT SANDING DISC..50 PER BOX	\$ 27.41
M IR :23-342-400	6" 400 GRIT SANDING DISC..100 PER BOX	\$ 43.09
M IR :23-252-024	8" 24 GRIT SANDING DISC..50 PER BOX	\$ 65.13
M IR :23-352-036	8" 36 GRIT SANDING DISC..50 PER BOX	\$ 99.12
M IR :23-352-080	8" 80 GRIT SANDING DISC..50 PER BOX	\$ 71.98

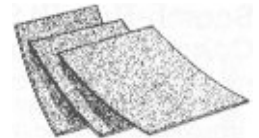
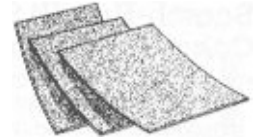

MONDAY-FRIDAY
8am-5pm a helpful
HUMAN voice will
always answer the
phone
(770)474-1286

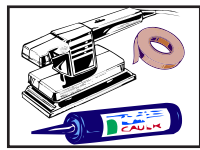

ADHESIVES & ABRASIVES

ABRASIVE ROLLS

3M Wet Or Dry Fabricut Rolls

Made from a flexible, synthetic open mesh screen type backing, this roll abrasive is coated on both sides with a tough aluminum oxide mineral. It is ideal for cleaning rusted or corroded surfaces. It can be used in or around water, oil, or axle grease without loading.

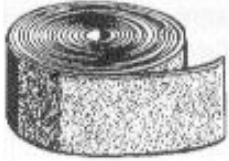

3M :05071	1 1/2" X 50 YARD WET OR DRY FABRICUT ROLLS 180 GRIT..1ROLL	\$ 39.35
3M :05072	1 1/2" X 50 YARD WET OR DRY FABRICUT ROLLS 120 GRIT..1ROLL	\$ 44.40
3M :05073	1 1/2" X 50 YARD WET OR DRY FABRICUT ROLLS 80 GRIT..1ROLL	\$ 74.58

3M Three-M-Ite Elek-Tro-Cut Cloth Utility Roll

This abrasive is used for smoothing rough spots, deburring and cleaning metal surfaces.



3M :05001	1" X 50 YARD ELEK-TRO CUT ROLL ABRASIVE 400 GRIT..1ROLL	\$ 48.69
3M :05002	1" X 50 YARD ELEK-TRO CUT ROLL ABRASIVE 320 GRIT..1ROLL	\$ 35.42
3M :05003	1" X 50 YARD ELEK-TRO CUT ROLL ABRASIVE 280 GRIT..1ROLL	\$ 34.86
3M :05004	1" X 50 YARD ELEK-TRO CUT ROLL ABRASIVE 240 GRIT..1ROLL	\$ 34.86
3M :05005	1" X 50 YARD ELEK-TRO CUT ROLL ABRASIVE 220 GRIT..1ROLL	\$ 34.86
3M :05006	1" X 50 YARD ELEK-TRO CUT ROLL ABRASIVE 180 GRIT..1ROLL	\$ 38.01
3M :05007	1" X 50 YARD ELEK-TRO CUT ROLL ABRASIVE 150 GRIT..1ROLL	\$ 34.86
3M :05008	1" X 50 YARD ELEK-TRO CUT ROLL ABRASIVE 120 GRIT..1ROLL	\$ 34.86
3M :05009	1" X 50 YARD ELEK-TRO CUT ROLL ABRASIVE 100 GRIT..1ROLL	\$ 38.00
3M :05010	1" X 50 YARD ELEK-TRO CUT ROLL ABRASIVE 80 GRIT..1ROLL	\$ 39.32
3M :05011	1" X 50 YARD ELEK-TRO CUT ROLL ABRASIVE 60 GRIT..1ROLL	\$ 48.69
3M :05021	1 1/2" X 50 YARD ELEK-TRO CUT ROLL ABRASIVE 400 GRIT..1ROLL	\$ 48.69
3M :05022	1 1/2" X 50 YARD ELEK-TRO CUT ROLL ABRASIVE 320 GRIT..1ROLL	\$ 49.46
3M :05026	1 1/2" X 50 YARD ELEK-TRO CUT ROLL ABRASIVE 180 GRIT..1ROLL	\$ 51.59
3M :05028	1 1/2" X 50 YARD ELEK-TRO CUT ROLL ABRASIVE 120 GRIT..1ROLL	\$ 44.39
3M :05030	1 1/2" X 50 YARD ELEK-TRO CUT ROLL ABRASIVE 80 GRIT..1ROLL	\$ 53.49
3M :05048	2" X 50 YARD ELEK-TRO CUT ROLL ABRASIVE 120 GRIT..1ROLL	\$ 56.43
3M :05050	2" X 50 YARD ELEK-TRO CUT ROLL ABRASIVE 80 GRIT..1ROLL	\$ 59.18

Other Brands

FAC :1-1/2X25180G	180 GRIT MESH EMERY CLOTH..25 YD ROLL	\$ 29.86
FAC :1-1/2X25-120G	120 GRIT MESH EMERY CLOTH..25 YD ROLL	\$ 28.24
FAC :1-1/2X25-80G	80 GRIT MESH EMERY CLOTH..25 YD ROLL	\$ 29.86

Mechanics Abrasive Roll

Designed for general purpose deburring, sanding, and clean up work, this abrasive can be used on metal as well as many other surfaces. It is resistant to humidity and makes it comfortable to sand hard to get places.



FAC :1X50ZX40G	40 GRIT BLUE ZIRCONIUM RESIGN CLOTH..50 YD ROLL	\$ 84.01
FAC :1X50Z60Y	60 GRIT BLUE ZIRCONIUM RESIGN CLOTH..50 YD ROLL	\$ 65.11
3M :05107	1 1/2" X 20 YARD MECHANICS ABRASIVE ROLL 400 GRIT..1ROLL	\$ 16.20
3M :05150	1" X 20 YARD MECHANICS ABRASIVE ROLL 320 GRIT..1ROLL	\$ 11.00
PAC :SR1060	60 GRIT ABRASIVE ROLL..1" X 50 YD	\$ 24.34
PAC :SR1080	80 GRIT ABRASIVE ROLL..1" X 50 YD	\$ 16.15
PAC :SR1100	100 GRIT ABRASIVE ROLL..1" X 50 YD	\$ 18.88
PAC :SR1120	120 GRIT ABRASIVE ROLL..1" X 50 YD	\$ 21.48
PAC :SR1150	150 GRIT ABRASIVE ROLL..1" X 50 YD	\$ 22.66
PAC :SR1180	180 GRIT ABRASIVE ROLL..1" X 50 YD	\$ 22.66

PARKER, BROTHERS, INC.

PARKER, BROTHERS, INC.

PARKER, BROTHERS, INC.

ADHESIVES & ABRASIVES

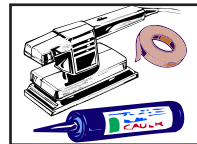

ABRASIVE ROLLS

Mechanics Abrasive Roll

Designed for general purpose deburring, sanding, and clean up work, this abrasive can be used on metal as well as many other surfaces. It is resistant to humidity and makes it comfortable to sand hard to get places.

PAC:SR1240	240 GRIT ABRASIVE ROLL..1" X 50 YD	\$ 22.66
PAC:SR1320	320 GRIT ABRASIVE ROLL..1" X 50 YD	\$ 22.66
PAC:SR2080	80 GRIT ABRASIVE ROLL..1 1/2" X 50 YD	\$ 40.08
PAC:SR2120	120 GRIT ABRASIVE ROLL..1 1/2" X 50 YD	\$ 32.19
PAC:SR2180	180 GRIT ABRASIVE ROLL..1 1/2" X 50 YD	\$ 40.12
PAC:SR2220	220 GRIT ABRASIVE ROLL..1 1/2" X 50 YD	\$ 40.28
PAC:SR2320	320 GRIT ABRASIVE ROLL..1 1/2" X 50 YD	\$ 42.22
PAC:SR2400	400 GRIT ABRASIVE ROLL..1 1/2" X 50 YD	\$ 40.28
PAC:SR3120	120 GRIT ABRASIVE ROLL..2" X 50 YD	\$ 35.87



GRINDING DISC

3M Green Corps Roloc Disc

These handy quick change discs are perfect for those small grinding jobs.

3M:01396	2" GREEN CORPS ROLOC DISC 50 GRIT..25 PER BOX	\$ 33.78
3M:01397	2" GREEN CORPS ROLOC DISC 36 GRIT..25 PER BOX	\$ 41.33
3M:01398	2" GREEN CORPS ROLOC DISC 24 GRIT..25 PER BOX	\$ 43.61
3M:01406	3" GREEN CORPS ROLOC DISC 50 GRIT..25 PER BOX	\$ 36.89
3M:01407	3" GREEN CORPS ROLOC DISC 36 GRIT..25 PER BOX	\$ 41.12
3M:01408	3" GREEN CORPS ROLOC DISC 24 GRIT..25 PER BOX	\$ 51.67



Other Brands

MIR:63-300-036	3" 36 GRIT GRINDING DISC..20 PER BOX	\$ 53.34
MIR:63-300-060	3" 60 GRIT GRINDING DISC..20 PER BOX	\$ 53.34
MIR:63-300-120	3" 120 GRIT GRINDING DISC..20 PER BOX	\$ 53.34
PAC:DC4030	4" X 1/4" X 5/8" GRINDING WHEEL..1 EACH	\$ 2.00
PAC:DC4510	4 1/2" X 1/4" X 7/8" GRINDING WHEEL..1 EACH	\$ 2.98
PAC:DC4510T	4 1/2" X 1/4" X 7/8" GRINDING WHEEL..1 EACH	\$ 1.61
PAC:DC7020TH	7" X 1/4" X 5/8-11 GRINDING WHEEL..1 EACH	\$ 2.99
FAC:4X1/4X5/8	GRINDING WHEEL..1 EACH	\$ 1.99
FAC:41/2X5/8-11	GRINDING WHEEL WITH NUT..1 EACH	\$ 3.48
FAC:41/2X1/4X7/8	GRINDING WHEEL..1 EACH	\$ 1.83
FAC:5X7/8X24	24 GRIT RESIN FIBER SANDING DISC..25 PER BOX	\$ 25.87
FAC:809775-00111	24 GRIT 5" RESIN FIBER GRINDING DISC..100 PER SLEEVE	\$ 59.75
FAC:05121	60 GRIT 6" X3/4" X 1" GRINDING WHEEL..1 EACH	\$ 19.34
FAC:05821	120 GRIT 8" X 1" X 1 1/4" GRINDING WHEEL	\$ 45.92
FAC:7X1/8X5/8-11	GRINDING WHEEL WITH NUT..1 EACH	\$ 9.59
FAC:7X1/4X5/8	GRINDING WHEEL..1 EACH	\$ 7.30
FAC:7X1/4X5/8-11	GRINDING WHEEL WITH NUT..1 EACH	\$ 5.71
FAC:7X1X1/4	GRINDING WHEEL..1 EACH	\$ 15.45
FAC:8X1X1/4-36G	GRINDING WHEEL WITH NUT..1 EACH	\$ 23.90
FAC:10INROCK-11/4X36G	36 GRIT 10" GRINDING WHEEL..1 EACH	\$ 27.98



MISCELLANEOUS ABRASIVES

3m Rotor Surfacing Disc

These premium 120 grit Roloc sanding discs are designed to create a non-directional scratch pattern on brake rotor surfaces after turning. The starter pack includes 1 3M Roloc disc pad holder.

3M:01410	3" ROLOC BRAKE ROTOR SURFACING DISCS STARTER PACK..9 DISCS / 1 DISC PAD HOLDER	\$ 39.95
3M:01411	3" ROLOC BRAKE ROTOR SURFACING DISCS ..12 DISCS	\$ 22.86

3M Clean And Polish Rolls

Designed to be used with 3M mini mandrel, these 3 inch abrasive strips allow for cleaning in dimensions of cylinders

3M:07479	1" X 10" COARSE CLEAN AND POLISH ROLL..1 ROLL	\$ 9.03
3M:07478	1" X 10" MEDIUM CLEAN AND POLISH ROLL..1 ROLL	\$ 9.03
3M:07490	MINI MANDREL..1 EACH	\$ 15.02

Flap Wheels And Discs

MIR:61-231-024	5" 24 GRIT GRINDING DISC..25 PER BOX	\$ 51.66
MIR:61-231-036	5" 36 GRIT GRINDING DISC..25 PER BOX	\$ 45.72
MIR:61-254-024	7" 24 GRIT GRINDING DISC..25 PER BOX	\$ 60.40
MIR:61-254-036	7" 36 GRIT GRINDING DISC..25 PER BOX	\$ 47.93



Parker Brothers
gladly accepts
Visa, Mastercard
Discover &
American Express

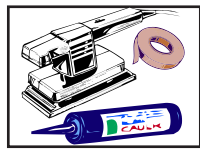

ADHESIVES & ABRASIVES

MISCELLANEOUS ABRASIVES

Flap Wheels And Discs

FAC:1X5/8X1/4-80G	80 GRIT FLAP WHEEL..1 EACH	\$ 2.31
FAC:1X3/4X1/4	80 GRIT FLAP WHEEL..10 PER BOX	\$ 18.90
FAC:1X1-80G	80 GRIT FLAP WHEEL..1 EACH	\$ 2.85
FAC:1X1X1/4-80G	80 GRIT FLAP WHEEL..1 EACH	\$ 2.99
FAC:1X1/2-80G	80 GRIT FLAP WHEEL..1 EACH	\$ 3.31
FAC:1-1/2X1X1/4-80G	80 GRIT FLAP WHEEL..1 EACH	\$ 3.06
FAC:2X3/4X1/4	80 GRIT FLAP WHEEL..1 EACH	\$ 3.09
FAC:3X1X1/4-80G	80 GRIT FLAP WHEEL..1 EACH	\$ 4.41
FAC:4X5/8AF-060	60 GRIT FLAP DISK..1 EACH	\$ 7.76
FAC:4-1/2X7/8	FIBERGLASS FLAP DISC..1 EACH	\$ 2.48
FAC:41/2FLAPDISC	60 GRIT FLAP DISC WITH NUT..1 EACH	\$ 9.87

3M Bench Motor Wheel

3M :07744	6" BENCH MOTOR WHEEL..1 EACH	\$ 31.94
3M :16544	6"X1"X1" 2A-MED.UNITIZED WHEEL..1 EACH	\$ 34.88

Other Abrasives

DRY:GLASS-BEADS	#8 GLASS BEADS..50 LB	\$ 60.67
DRY:WALNUT-SHELL	WALNUT SHELL..50 LB	\$ 37.85

SCOTCH-BRITE PADS

3M Scotch-Brite Pads

These re-useable pads have a wide variety of uses. White pads are light duty and for use on panels prior to clear coat blending. Maroon Pads are general purpose and for scuffing before applying paint and primer. They also can be used to clean upholstery, head liners, door pads, and white walls. Gray pads are ultra fine and for final sanding of primer..

3M :07445	SCOTCH-BRITE CLEANSING PAD..10 PER BOX	\$ 22.26
3M :07447	SCOTCH-BRITE GENERAL PURPOSE PAD..20 PER BOX	\$ 21.59
3M :07448	SCOTCH-BRITE ULTRA FINE PAD..20 PER BOX	\$ 25.04

SPECIALITY CLEANING & STRIPPING DISC

3M Rust And Paint Stripper

This tough, non-woven, synthetic material disc is designed to attach to an electric drill and remove rust, scale, and paint from metal surfaces. It is flexible and will not rust or splinter. It can also be used to sand wood, fiberglass and plastics.

3M :03171	RUST & PAINT STRIPPER WITH MANDREL..1 EACH	\$ 5.72
-----------	--	---------

3M Clean 'N Strip Disc

3M :07460	4" x 1/4" CLEAN & STRIP DISC-BLACK..1 EACH	\$ 70.80
3M :07466	4" x 1/2" CLEAN & STRIP ROLOC DISC-BLACK..1 EACH	\$ 9.72

3M Clean 'N Strip Disc Mandrel

3M :07491	DISC MANDREL..1 EACH	\$ 5.61
-----------	----------------------	---------

3M Coating Removal Utility Disc

This 3 dimensional abrasive disc conforms to your work area for removing paint and rust. It is the perfect tool in seams, door jams, drip moldings, and other difficult to reach places.

3M :07461	3" ROLOC CRUD REMOVER..1 EACH	\$ 6.29
-----------	-------------------------------	---------

CUT-OFF WHEELS

3M Green Corps Cut-Off Wheels

These long lived, high performance cut-off wheels are for use on utility cutting tools.

3M :01989	3" CUTOFF WHEELS 3X1/32X3/8..5 WHEELS PER PACK	\$ 29.90
3M :01990	3" CUTOFF WHEELS 3X1/16X3/8..5 WHEELS PER PACK	\$ 29.90

Other Brands

FAC:3X035X1/4	REINFORCED CUTOFF WHEEL..1 EACH	\$ 1.11
FAC:3X1/16X1/4	REINFORCED CUTOFF WHEEL..1 EACH	\$ 1.05
FAC:3X035X3/8	REINFORCED CUTOFF WHEEL..1 EACH	\$ 1.50
FAC:3X1/32X3/8	REINFORCED CUTOFF WHEEL..1 EACH	\$ 0.89
FAC:3X1/16X3/8	REINFORCED CUTOFF WHEEL..1 EACH	\$ 1.05
FAC:3X3/32X3/8	REINFORCED CUTOFF WHEEL..1 EACH	\$ 1.12
FAC:4X035X1/4	REINFORCED CUTOFF WHEEL..1 EACH	\$ 1.30
FAC:4X1/16X1/4	REINFORCED CUTOFF WHEEL..1 EACH	\$ 1.43
FAC:4X035X3/8	REINFORCED CUTOFF WHEEL..1 EACH	\$ 1.65
FAC:4X1/32X3/8	REINFORCED CUTOFF WHEEL..1 EACH	\$ 0.99

ADHESIVES & ABRASIVES

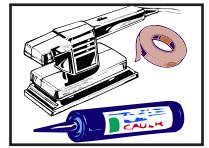

CHOP SAW BLADES

Chop Saw Blades

FAC:10X1/8X1	REINFORCED CUTOFF WHEEL..1 EACH	\$ 7.62
FAC:12X1/8X1	REINFORCED CUTOFF WHEEL..1 EACH	\$ 8.12
FAC:12X5/32X1	REINFORCED CUTOFF WHEEL..1 EACH	\$ 9.89
FAC:12X1/8X20MM	REINFORCED CUTOFF WHEEL..1 EACH	\$ 6.59
FAC:14X1/8X1	REINFORCED CUTOFF WHEEL..1 EACH	\$ 10.31
FAC:14X1/8X20MM	REINFORCED CUTOFF WHEEL..1 EACH	\$ 13.78
PAC:CW1420	14" X 1/8" X 1" CHOP SAW BLADES..1 EACH	\$ 6.27
PAC:CW1420SR	14" X 1/8" X 1" CHOP SAW BLADES..1 EACH	\$ 15.99
PAC:CW1420T	14" X 1/8" X 1" CHOP SAW BLADES..1 EACH	\$ 9.65

PARKER, BROTHERS, INC.

PARKER, BROTHERS, INC.

PARKER, BROTHERS, INC.

PARKER, BROTHERS, INC.

PARKER, BROTHERS, INC.

PARKER, BROTHERS, INC.

PARKER, BROTHERS, INC.

FOR 50+ YEARS,
PARKER BROTHERS
HAS BEEN SERVING ATLANTA. **THANK YOU FOR YOUR CONTINUED
SUPPORT!!**



TIRE SUPPLIES

PATCHES
PATCHING ACCESSORIES
PLUGS
PLUGGING ACCESSORIES
PLUG-N-PATCH
REPAIR KITS
TIRE VALVES, CORES, AND CAPS
VALVE TOOLS
AIR CHUCKS
TIRE PRESSURE GAUGES
INFLATOR GAUGES & REPAIR PARTS
FLAT REPAIR
MISCELLANEOUS TIRE SUPPLIES
ALIGNMENT SHIMS
WHEEL WEIGHT TOOL
WHEEL WEIGHTS

TIRE SUPPLIES



PATCHES

Camel Reinforced Boots

These heavy duty patches have right angle cord construction for high tension strength. They will not dry out or self cure

CAM :13-102	3 1/4" REINFORCED UNITIZED BOOT..20 PER BOX	\$ 25.52
-------------	---	----------

Other Brands

W/W:PN-1	2 1/2" TIRE PATCHES..30 PER BOX	\$ 22.25
W/W:PN-2	3 1/4" TIRE PATCHES..20 PER BOX	\$ 36.67
W/W:PN-3	3 1/2" TIRE PATCHES..10 PER BOX	\$ 32.26
W/W:PN-4	4 3/4" TIRE PATCHES..10 PER BOX	\$ 42.39
W/W:PN-5	6" TIRE PATCHES..10 PER BOX	\$ 62.32

Camel "Cam-Cure" Radial Repair Units

Each repair features our exclusive centerline construction to insure that the repair unit is placed center over the injury the first time. They meet or exceed all standards and out last many competitive products.

CAM :13-312	2 3/4" X 4 1/2" RADIAL REPAIR UNITS..20 PER BOX	\$ 43.72
-------------	---	----------

Camel "Cam-Cure" Bias Ply Repair Units

Each repair features our exclusive centerline construction to insure that the repair unit is placed center over the injury the first time. They meet or exceed all standards and out last many competitive products.

CAM :13-252	3 1/4" BIAS PLY REPAIR UNITS..20 PER BOX	\$ 27.25
CAM :13-254	5" BIAS PLY REPAIR UNITS..10 PER BOX	\$ 38.45

Camel Radial Repair Patches

These patches are used for nail holes in automobile and light truck tires. They are of heavier construction than Chembond patches.

CAM :14-137	SMALL RADIAL PATCHES..30 PER BOX	\$ 22.61
CAM :14-139	MEDIUM RADIAL PATCHES..20 PER BOX	\$ 26.53
CAM :14-140	LARGE RADIAL PATCHES..10 PER BOX	\$ 24.05

Camel Chembond Patches

These world famous patches use pure rubber to flow into the injury.

CAM :14-152	SMALL ROUND CHEMBOND PATCHES ..40 PER BOX	\$ 13.84
CAM :14-153	MEDIUM ROUND CHEMBOND PATCHES ..30 PER BOX	\$ 16.18
CAM :14-154	LARGE ROUND CHEMBOND PATCHES ..20 PER BOX	\$ 15.95
CAM :14-157	SMALL OVAL CHEMBOND PATCHES ..30 PER BOX	\$ 25.88
CAM :14-158	MEDIUM OVAL CHEMBOND PATCHES..20 PER BOX	\$ 16.67
CAM :14-159	LARGE OVAL CHEMBOND PATCHES..20 PER BOX	\$ 22.82

Camel Perma Strip Patches

These patches are used for bias and non-steel belted radial tires.

CAM :15-179	PERMA STRIP PATCH KIT	\$ 14.60
-------------	-----------------------	----------

PATCHING ACCESSORIES

Camel Boot Cement

This non-flammable cement is for use on boots and tire patches with inner tubes.

CAM :12-075	BOOT CEMENT..1/2 PT CAN	\$ 8.33
-------------	-------------------------	---------

Camel Universal Cement

This non-flammable cement can be used on any kind of patching job.

CAM :12-086	UNIVERSAL CEMENT..1/2 PT CAN	\$ 10.78
CAM :12-089	UNIVERSAL CEMENT..1 QT CAN	\$ 33.64

Camel Cam-Cure Heavy Duty Cement

This non-flammable cement, designed for heavy duty applications, must be used with Cam-Cure repair units to insure a permanent bond

CAM :12-087	HEAVY DUTY CEMENT..1/2 PT CAN	\$ 10.53
-------------	-------------------------------	----------

Camel Buffer /Cleaner

This product is designed to clean and prepare the rubber so patches adhere properly. It should be used before all power buffing.

CAM :12-092	LIQUID BUFFER..1 QT CAN	\$ 11.07
CAM :12-093	SPRAY BUFFER..16 OZ AEROSOL CAN	\$ 7.88

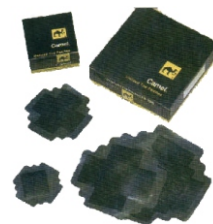

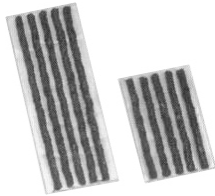

FOR 50+ YEARS,
PARKER
BROTHERS
HAS BEEN
SERVING ATLANTA.
THANK YOU FOR
YOUR CONTINUED
SUPPORT!!



TIRE SUPPLIES

PATCHING ACCESSORIES

Camel Manual Buffers And Stitchers

CAM :17-237	COMBINATION BUFFER/STITCHER	\$ 5.13
CAM :17-238	BUFFER STICK	\$ 1.13
CAM :17-244	HEAVY DUTY STITCHER	\$ 7.13
CAM :14-314	STITCHER	\$ 6.71

Buffing Cones

CAM :18-259	2 1/2" HEAVY DUTY AUTOMOTIVE BUFFING CONE	\$ 7.29
CAM :18-260	2" STANDARD AUTOMOTIVE BUFFING CONE	\$ 8.10
TMR :TI10	2 1/2" BUFFING WHEEL..1 EACH	\$ 2.42

Buffing Cone Arbor

TMR :TI15	THREADED ARBOR FOR BUFFING WHEEL..1 EACH	\$ 3.46
-----------	--	---------

PLUGS

Camel Radial Inserts

This is the most popular emergency repair for most auto and light truck radial tires.

CAM :15-184	4" RADIAL INSERTS..20 PER BOX	\$ 15.14
-------------	-------------------------------	----------

Other Brands

TMR :ST 1933	4" TIRE STRINGS..60 PER BOX	\$ 18.16
TMR :ST 1934	8" TIRE STRINGS..30 PER BOX	\$ 7.63

Camel Bias Ply Inserts

These inserts are used for emergency repairs on bias ply and tubeless tires.

CAM :15-206	7" STRING REPAIRS..50 PER BOX	\$ 21.71
-------------	-------------------------------	----------

Camel Truck Radial Inserts

These heavy duty inserts are excellent for emergency repair of nail holes in truck tires.

CAM :15-281	7" STEEL BELTED RADIAL TRUCK INSERTS..60 PER BOX	\$ 30.97
CAM :15-207	7 1/2" HEAVY DUTY STRING REPAIRS..50 PER BOX	\$ 22.97

Other Brands

CHC :CHEM -CURE	7" TIRE STRINGS..80 PER BOX	\$ 24.55
CHC :LT40	14" TIRE STRINGS..40 PER BOX	\$ 15.03
TMR :ST9	7" TIRE STRINGS..50 PER BOX	\$ 10.35

Camel Bias Ply Ribbed Gun Plugs

These plugs are designed to be used in off road tires only.

CAM :15-185	5/16" GUN PLUGS..25 PER BOX	\$ 13.07
-------------	-----------------------------	----------

PLUGGING ACCESSORIES

Camel Screwdriver Type Reamers

CAM :15-174	PROBE	\$ 4.41
-------------	-------	---------

T-Handle Reamers

CAM :14-211	SUPER GRIP TIRE PROBE	\$ 10.55
CAM :15-225	SUPER GRIP TIRE PROBE	\$ 10.78
CAM :15-232	SPIRAL GRIP CEMENT TOOL	\$ 11.99

Camel Screwdriver Type Tire Pluggers

CAM :15-172	OPEN EYE REPAIR NEEDLE INSERT TOOL	\$ 5.45
-------------	------------------------------------	---------

Camel T-Handle Tire Pluggers

CAM :15-224	SUPER GRIP OPEN EYE NEEDLE INSERT TOOL	\$ 9.92
CAM :15-226	SUPER GRIP CLOSED EYE NEEDLE INSERT TOOL	\$ 6.91
CAM :15-227	SUPER GRIP SPLIT EYE NEEDLE INSERT TOOL	\$ 10.33
CAM :15-231	HEAVY DUTY TRUCK NEEDLE INSERT TOOL	\$ 29.45

Other Brands

TMR :TI48	METAL T HANDLE SPIRAL PROBE AND INSERT TOOL..1 EACH	\$ 17.08
CHC :L150	INSERT TOOL..1 EACH	\$ 3.15
CHC :TT	TRUCK INSERT TOOL..1 EACH	\$ 5.44

Replacement Needles

CAM :15-072	OPEN EYE REPLACEMENT NEEDLE	\$ 4.03
TMR :TI48-B	REPLACEMENT OPEN-EYE NEEDLE..1 EACH	\$ 6.54

TIRE SUPPLIES



PLUG-N-PATCH

Camel Plug-N-Patch

These repair units will repair tires with nail hole injuries in the crown or sidewall, including speed rated radial tires. The repair unit is cemented on the inside of the tire and pushed through the injury hole.

CAM :15-290	SMALL REINFORCED PLUG AND PATCH..15 PER BOX	\$ 36.07
CAM :15-291	MEDIUM REINFORCED PLUG N PATCH..10 PER BOX	\$ 38.14
CAM :15-293	SMALL SIDEWALL PLUG N PATCH..20 PER BOX	\$ 29.81
CAM :15-295	SMALL ROUND MOLDED PLUG N PATCH..50 PER BOX	\$ 76.64
CAM :15-296	MEDIUM ROUND MOLDED PLUG N PATCH..20 PER BOX	\$ 34.79
CAM :15-297	LARGE ROUND MOLDED PLUG N PATCH..20 PER BOX	\$ 33.35



REPAIR KITS

Camel Cold Patch Rubber Repair Kit

Our most popular kit for home repairs. Each kit contains 10 square inches of rubber (for repairing tears), 3 1"x1" patches, .3oz of cement and 1 thumb buffer.

CAM :11-049	RUBBER REPAIR KIT	\$ 2.16
-------------	-------------------	---------

Camel Cam-Cure Professional Tire Repair Center

This repair center contains everything the busy tire repair shop or heavy equipment shop needs. It contains enough materials to do over 390 tire repairs. (Receive a heavy guage steel cabinet with three movable shelves for storage.

CAM :13-240	PROFESSIONAL TIRE REPAIR CENTER..1 EACH	\$ 474.01
-------------	---	-----------



Camel Radial Super-Grip Emergency Tire Repair Kit

This kit contains 5 radial inserts, .3 ozs of cement, super grip probe, and an open eye plugger. For use on non-speed rated tires and all bias ply tires.

CAM :15-162	SUPER-GRIP EMERGENCY TIRE REPAIR KIT	\$ 14.83
-------------	--------------------------------------	----------

Camel Radial Tire Repair Kit

This kit contains 10 7" repair plugs and a closed eye plugger. It is not for speed rated tires.

CAM :15-165	EMERGENCY REPAIR RADIAL TIRE KIT	\$ 5.38
-------------	----------------------------------	---------

Camel Tubeless Tire Repair Kit

This kit contains six assorted plugs, .3 ozs cement and an open eye plugger. Not for use on radial tires.

CAM :15-168	TUBELESS TIRE REPAIR KIT	\$ 4.30
-------------	--------------------------	---------



Camel Perma Strip Patch

This kit contains six strips, .3 ozs cement and an open eye plugger. For use on bias ply, and non-steel belted radial tires

CAM :15-169	PERMA STRIP PATCH	\$ 4.59
-------------	-------------------	---------

Camel Radial Tire Repair Kit

This kit contains 2 boxes of 15-184 radial inserts, 1/4pt cement, t-handle reamer, t-handle plugger, and a carrying case.

CAM :15-189	PROFESSIONAL TIRE REPAIR DEALER KIT	\$ 54.23
-------------	-------------------------------------	----------

Camel Tubeless Tire Repair Kit

This kit contains 50 PERMA plugs, 1/2.pt of cement, a plugger, and a reamer.

CAM :15-178	6 P C PATCH KIT..1 KIT	\$ 41.72
-------------	------------------------	----------

TIRE VALVES, CORES, & CAPS

Milton Valve Cores

Thread size : .2108-36, red teflon seal. Operating temperature range : -40F to 320F. Operating pressure : 0 - 200 PSI. Meets specification TR-C1.

MIL:404-100	VALVE CORES..100 PER BOX..1 BOX	\$ 24.96
-------------	---------------------------------	----------



404

Other Brands

TMR:T170	STANDARD TIRE VALVE CORES..100 PER BOX	\$ 10.01
----------	--	----------

Milton Hi-Performance Tire Valves

For use with mag, aluminum, exposed or reversed chrome wheels. Clamp in type, brass chrome plated. Complete with two grommets to fit .453 or .625 valve holes.

MIL:S409	HIGH PERFORMANCE VALVE STEM..1 EACH	\$ 3.44
----------	-------------------------------------	---------



409





TIRE SUPPLIES

TIRE VALVES, CORES, & CAPS

413 414 415



Milton Valve Stems

Snap in type. Cap thread size : .305-32. Ozone resistant rubber. Maximum cold inflation pressure : 60PSI

MIL:413	1 1/4" X .453 VALVE STEM ..1 EACH	\$ 0.25
MIL:414	1 1/2" X .453 VALVE STEM ..1 EACH	\$ 0.26
MIL:415	1 1/4" X .625 VALVE STEM ..1 EACH	\$ 0.43
MIL:418	2" X .453 VALVE STEM ..1 EACH	\$ 0.33
MIL:423	2 1/2" X .453 VALVE STEM ..1 EACH	\$ 0.76
MIL:425	2" X .625 VALVE STEM ..1 EACH	\$ 0.75

Other Brands

TMR:TR413-EA	1 1/4" X .453 VALVE STEM ..1 EACH	\$ 0.17
TMR:TR413-500	1 1/4" X .453 VALVE STEM ..500 PER BOX	\$ 92.96
TMR:TR418-500	2" X .453 VALVE STEM ..500 PER BOX	\$ 106.00

418 423 425

Milton Chrome Sleeve Tubeless Tire Valve

Chrome sleeve tubeless tire valve with hex cap. Fits .453 rim holes. Replaces Tr413 and Tr418.

MIL:S413-1	1 1/4" X .453..CHROME SLEEVE VALVE STEM ..2 PER CARD	\$ 1.89
MIL:S418-1	MIL 2" X .453 CHROME SLEEVE VALVE STEM ..1 EACH	\$ 1.83



Milton Valve Caps

Nickle plated, heavy knurl heat resistant sealing washer.

MIL:434	H I PERFORMANCE NICKLE PLATED VALVE CAP ..1 EACH	\$ 0.37
---------	--	---------

Hex head, all brass, chrome plated.

MIL:S435	CHROME PLATED VALVE CAP ..4 PER CARD	\$ 1.29
MIL:435-100	CHROME PLATED VALVE CAPS ..100 PER BOX..1 BOX	\$ 4.01

Dome type, brass, nickle plated, meets spec. TR VC3.

MIL:436	NICKLE PLATED DOME VALVE CAP ..1 EACH	\$ 0.23
MIL:436-100	NICKLE PLATED DOME VALVE CAPS ..100 PER BOX..1 BOX	\$ 6.78

Screw driver type, brass, nickle plated, meets spec. TR VC2.

MIL:437	SCREW DRIVER TYPE VALVE CAP ..1 EACH	\$ 0.25
---------	--------------------------------------	---------

Dome shape, plastic. TR VC8. Standard valve cap. Thread size : .305-32.

MIL:439	PLASTIC VALVE CAPS ..100 PER BOX..1 BOX	\$ 2.00
---------	---	---------

Other Brands

TMR:TI100	PLASTIC TIRE VALVE CAP ..100 PER BOX	\$ 8.53
TMR:TI103	STAINLESS STEEL DOME VALVE CAP ..100 PER BOX	\$ 11.00
TMR:TI102	CHROME VALVE CAP ..100 PER BOX	\$ 11.00
TMR:TI101	LONG SKIRTED CHROME VALVE CAP ..100 PER BOX	\$ 12.00

434 S435 436

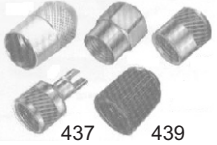

Milton Brass Valve Extensions

Dust cover design allows pressure check and inflation/deflation without removing cap. Threaded for valve caps and/or wheel cover locks. Threaded : .302-32.

MIL:S441	3/4" BRASS VALVE EXTENSION ..4 PER CARD	\$ 4.12
MIL:S442	1 1/4" BRASS VALVE EXTENSION ..4 PER CARD	\$ 4.99



454 453 452

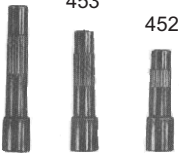

Milton Plastic Valve Extensions

Lightweight so it does not affect wheel balance. Extends through hole in cover for easy inflating or checking tire pressure.

MIL:451	3/4" PLASTIC VALVE EXTENSION ..1 EACH	\$ 0.26
MIL:451-100	3/4" PLASTIC VALVE EXTENSIONS ..100 PER BOX	\$ 9.77
MIL:452	1 1/4" PLASTIC VALVE EXTENSION ..1 EACH	\$ 0.28
MIL:452-100	1 1/4" PLASTIC VALVE EXTENSIONS ..100 PER BOX	\$ 8.95
MIL:453	1 1/2" PLASTIC VALVE EXTENSION ..1 EACH	\$ 0.37
MIL:454	2" PLASTIC VALVE EXTENSION ..1 EACH	\$ 0.42

Milton Air/Water Adapter Kit

This kit is used to connect a 3/4" garden hose to a tire valve so the tire can be filled with liquid. Fits all tubes and tubeless valves in this section with core housing removed.

MIL:S466	AIR / WATER ADAPTER KIT ..1 EACH	\$ 38.52
----------	----------------------------------	----------

Milton Tubeless Air-Liquid Valve

TR 618A / Clamp-in tubeless valve for farm tractor and road grader tires. Fast filling large bore type. Complete with core housing. 2 1/2" length.

MIL:469	TUBELESS AIR / LIQUID TIRE VALVE ..1 EACH	\$ 4.34
---------	---	---------



S466



469

TIRE SUPPLIES



TIRE VALVES, CORES, & CAPS

Milton Safe-T-Flate

This handy clamp on extension makes checking pressure and inflating inner dual wheel tires much easier. Standard bore. Maximum pressure : 150PSI. Effective length 7".

M IL:S400-6	7" INNER DUAL WHEEL VALVE EXTENSION..1 EACH	\$ 3.36
-------------	---	---------



Milton Tube Type Tire Valves

Used on 13", 14", and 15" tubes, these patch valves are excellent for passenger cars, motorcycles, light trucks, and industrial vehicles. They are 1 3/8" long and are for .453 rim holes. Apply hot or cold. 2 1/4" base.

M IL:473	TUBE TYPE TIRE PATCH VALVE..1 EACH	\$ 2.50
----------	------------------------------------	---------



Milton Truck And Bus Clamp-In Tubeless Tire Valves

Straight clamp-in type valves for 5/8" side hole mounting. For demountable and non demountable rims.

M IL:482	1 21/32" CLAMP IN TUBELESS TIRE VALVE..1 EACH..(TR501)	\$ 3.04
M IL:484	3 9/32" CLAMP IN TUBELESS TIRE VALVE ..1 EACH..(TR570)	\$ 3.69
M IL:485	3 29/32" CLAMP IN TUBELESS TIRE VALVE ..1 EACH..(TR572)	\$ 0.98
M IL:486	4 17/32" CLAMP IN TUBELESS TIRE VALVE..1 EACH..(TR573)	\$ 1.15



Milton Tubeless Bottom Hole Tire Valves

Used in drop center aluminum disc wheels with 5/8" bottom valve hole.

M IL:492	TUBELESS VALVE..1 EACH	\$ 0.71
----------	------------------------	---------

Milton Clamp-In Tubeless Tire Valves

These valves are recommended where tire pressure exceeds 45 psi. Milton 470 rubber grommet fits .453 and 5/8 rim holes.

M IL:470	UNIVERSAL CLAMP IN TUBELESS TIRE VALVE..1 EACH	\$ 2.50
M IL:471	SPECIAL CLAMP IN TUBELESS TIRE VALVE..1 EACH	\$ 4.23

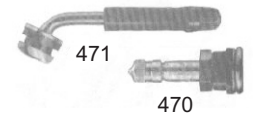
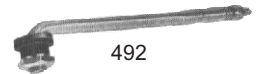

VALVE TOOLS

Milton Valve Core Tool

This tool is designed for the insertion and removal of valve cores. It is a combination tool with one end for large bore valves and the other for standard bore valves.

M IL:444	VALVE CORE TOOL..1 EACH	\$ 2.50
----------	-------------------------	---------



Other Brands

T MR:T165	SCREWDRIVER VALVE CORE TOOL..1 EACH	\$ 2.63
-----------	-------------------------------------	---------

Milton Valve Repair Tool

With this 4 in 1 tool, one can rethread inside and outside valve stems, and insert, tighten, or remove valve cores. It even allows for valve core removal if the shoulder is broken. Steel plated. Tap size : .2108-36.

M IL:S445	4 IN 1 VALVE REPAIR TOOL..1 EACH	\$ 1.27
-----------	----------------------------------	---------



Milton Tube Deflator And Core Remover

With this 2 in 1 tool, one can deflate tubes with one end and insert or remove valve cores with the other.

M IL:446	TUBE DEFLATOR AND CORE REMOVER..1 EACH	\$ 1.27
----------	--	---------

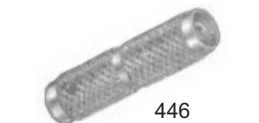

Milton Valve Fishing Tool

This 3 in 1 tool allows one to align and seal valve stem through rim holes. Plus, the handle deflates tubes and inserts or removes valve cores.

M IL:S447	VALVE FISHING TOOL..1 EACH	\$ 3.58
-----------	----------------------------	---------



Milton Valve Insertion Tool

This tool is for insertion or removal of snap in type tubeless tire valves.

M IL:S449	VALVE INSERTION TOOL..1 EACH	\$ 2.50
-----------	------------------------------	---------

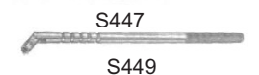

Milton Tube Deflator Tool

This tool allows for the complete deflation of all inner tubes on trucks, buses and passenger cars.

M IL:S450	TUBE DEFLATOR TOOL..1 EACH	\$ 1.30
-----------	----------------------------	---------



PARKER, BROTHERS, INC.





TIRE SUPPLIES

AIR CHUCKS

Milton Air Chucks

Designed and manufactured to exacting standards. Maximum pressure :150PSI. (Not for use with Milton inflator gages.

MIL:S690	DUAL HEAD AIR CHUCK..1/4 NPT FEMALE THREADS..1 EACH	\$ 5.75
----------	---	---------

DesigneSafety grip chuck clip. Fits all standard single head air chucks.

MIL:S692	SAFETY GRIP CHUCK CLIP ..1 EACH	\$ 2.82
----------	---------------------------------	---------

For inner duals, both ends lock on threads. 1/4" female NPT.

MIL:S693	DUAL HEAD STRAIGHT FOOT AIR CHUCK 1/4 NPT FEMALE THREADS..1 EACH	\$ 8.22
----------	--	---------

Chuck clip with male chuck

MIL:694	CHUCK CLIP WITH MALE CHUCK..1/4 BARB..1 EACH	\$ 2.71
---------	--	---------

Male air chuck

MIL:695	MALE AIR CHUCK..1/4 BARB..1 EACH	\$ 11.13
---------	----------------------------------	----------

Kwik grip safety chuck. 1/4" NPT female.

MIL:S696	KWIK-GRIP SAFETY CHUCK..1/4 NPT FEMALE THREADS..1 EACH	\$ 5.00
----------	--	---------

European style chuck clip. 1/4" Barbed.

MIL:697	EUROPEAN STYLE CHUCK CLIP ..1/4 BARB..1 EACH	\$ 2.03
---------	--	---------

TMR:EC6000C	FEMALE EURO AIR CHUCK..1 EACH	\$ 5.49
-------------	-------------------------------	---------

Chuck clip with female chuck

MIL:S698	CHUCK CLIP WITH CHUCK..1/4 NPT FEMALE THREADS..1 EACH	\$ 6.29
----------	---	---------

Female single head chuck

MIL:S699	SINGLE HEAD CHUCK..1/4 NPT FEMALE THREADS..1 EACH	\$ 1.89
----------	---	---------

Milton Large Bore Air Chucks And Tools

Large bore adapter. Reduces to standard bore. .302-32 threads. Complete with gasket (TR-AD1)

MIL:1460	LARGE BORE ADAPTER..1 EACH	\$ 3.26
----------	----------------------------	---------

Lock on air chuck.

MIL:1470	LOCK ON CHUCK..1/4 NPT FEMALE THREADS..1 EACH	\$ 19.42
----------	---	----------

Dual foot chuck. 1/4" NPT female. Large bore and standard vale. 9" handle.

MIL:1472	9" DUAL FOOT CHUCK,LRG BORE AND STNDRD VALVE, 1/4 NPT FEMALE THREADS, 1EACH	\$ 55.77
----------	---	----------

TIRE PRESSURE GAUGES

Milton Dial Type Tire Pressure Gauges

These precision made, stay accurate gauges are designed with rugged bronze bourdon tubes, brass gears, and an easy to read 2" face, and unbreakable lens. The pressure is indicated on the face until release valve is depressed. Every guage is checked against a master gauge before packaging. Mil S902 and MIL S903 are angled single head chucks.

MIL:S902	DIAL TIRE PRESSURE GAUGE..1 EACH	\$ 5.61
----------	----------------------------------	---------

MIL:S903	DIAL TIRE PRESSURE GAUGE..1 EACH	\$ 4.70
----------	----------------------------------	---------

Other Brands

CAM:40-420	0 - 60 PSI DIAL GAUGE	\$ 44.28
------------	-----------------------	----------

CAM:980-15	0 - 15 PSI MASTER DIAL GAUGE	\$ 48.71
------------	------------------------------	----------

CAM:980-60	0 - 60 PSI MASTER DIAL GAUGE	\$ 49.82
------------	------------------------------	----------

Milton Pencil Style Tire Pressure Gauges

These high quality, American made gauges feature rugged housing and durable 4 side nylon indicator bars. They all have Milton's certified accuracy are designed to have a long trouble free life.

Consumer pencil tire gauges are molded of rugged Delrin. Passenger car tire gauge for radial and conventional tires

MIL:S911	PLASTIC PENCIL TIRE PRESSURE GAUGE..1 EACH	\$ 5.03
----------	--	---------

Higher pressure automobile tires, including 60PSI mini spare tire. Built in tire depth gauge in 1/16" increments. 2 sides 10-70 PSI in 2lb. increments and to sides 60-500 kPa in 10 kPa units.

MIL:S920	PENCIL TIRE PRESSURE GAUGE..1 EACH	\$ 7.13
----------	------------------------------------	---------

Durable plated brass. Passenger car tire gauge for conventional and radial tires. 2 sides 5-50 PSI in 1lb increments and 2 sides 40-350 kPa in 10 kPa units.

MIL:S921	PENCIL TIRE PRESSURE GAUGE..1 EACH	\$ 4.69
----------	------------------------------------	---------

Durable plated brass. Truck, R.V., And bicycle tire gauge. 2 sides 20-120 PSI in 2lb increments and 2 sides 120-820 kPa in 20 kPa units.

MIL:S925	PENCIL TIRE PRESSURE GAUGE..TRUCK, RV, BICYCLE..1 EACH	\$ 4.88
----------	--	---------

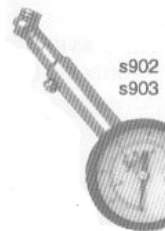
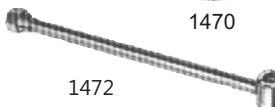
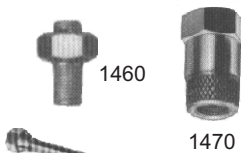
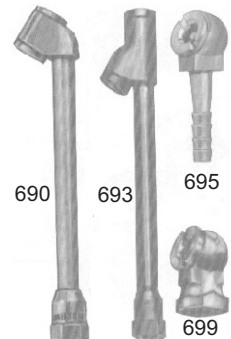
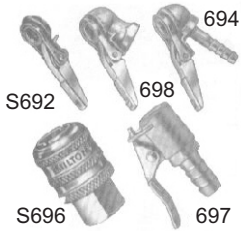

TIRE SUPPLIES



TIRE PRESSURE GAUGES

Milton Pencil Style Tire Pressure Gauges

These high quality, American made gauges feature rugged housing and durable 4 side nylon indicator bars. They all have Milton's certified accuracy are designed to have a long trouble free life Durable plated brass. Straight chuck passenger car tire gauge for conventional and radial tires. 2 sides 5-50 PSI in 1lb increments and 2 sides 40-350 kPa in 10 kPa units.

M IL:S923	PENCIL TIRE PRESSURE GAUGE..STRAIGHT CHUCK..1 EACH	\$ 15.73
-----------	--	----------

Durable plated brass. Dual chuck truck tire gauge. 2 sides 20-120 PSI in 2lb increments and 2 sides 120-820 kPa in 20 kPa units.

M IL:S927	PENCIL TIRE PRESSURE GAUGE..DUAL CHUCK..1 EACH	\$ 8.79
-----------	--	---------

Durable plated brass. Truck tire gauge for air/water filled radial tires. 2 sides 5-50 PSI in 1lb increments and 2 sides 40-350 kPa in 10 kPa units. (Pictured on previous page.)

M IL:S928	PENCIL TIRE PRESSURE GAUGE..AIR/WATER FILLED TIRES..1 EACH	\$ 7.98
-----------	--	---------

Milton Service Tire Pressure Gauges

Milton precision engineered service gauges provide accurate, long life, trouble free performance Plated brass tube and 4 sided nylon indicator bar. 2 sides 10-160 PSI in 2lb increments and 2 sides 80-1100 kPa in 20 kPa units.

Dual head chuck service gauge

M IL:S976	SERVICE TIRE PRESSURE GAUGE..DUAL HEAD CHUCK..1 EACH	\$ 20.47
-----------	--	----------

Straight foot dual head chuck service gauge for inner style duals.

M IL:S986	SERVICE TIRE PRESSURE GAUGE..STRAIGHT FOOT DUAL HEAD CHUCK..1 EACH	\$ 16.94
-----------	--	----------

Large bore dual head chuck service gauge.

M IL:982	SERVICE TIRE PRESSURE GAUGE..LARGE BORE DUAL HEAD CHUCK..1 EACH	\$ 33.39
----------	---	----------

INFLATOR GAUGES & REPAIR PARTS

Milton Window Inflator Gauges

These heavy duty gauges will with stand everyday use and abuse and provide long service life. Gauge cartridge and valve cartridge replacement. All window inflator gauges are equipped with magnifying lens for full view scale. 10-120 PSI in 2lb increments. (Available in metric, kPa)

Gauge complete straight head chuck. 15" hose.

M IL:504	STRAIGHT HEAD CHUCK WINDOW INFLATOR GAUGE..1 EACH	\$ 38.19
----------	---	----------

Gauge complete single head chuck (full swivel). 3' hose.

M IL:503	SINGLE CLIP HEAD CHUCK WINDOW INFLATOR GAUGE WITH 3' HOSE..1 EACH	\$ 44.49
----------	---	----------

Gauge complete single head chuck (full swivel). 15" hose.

M IL:505	SINGLE HEAD CHUCK WINDOW INFLATOR GAUGE..1 EACH	\$ 38.19
----------	---	----------

Gauge complete dual head chuck (full swivel). 15" hose.

M IL:S506	DUAL HEAD CHUCK WINDOW INFLATOR GAUGE..1 EACH	\$ 38.52
-----------	---	----------

Gauge complete dual head straight foot chuck with lock on threads both ends for inner dual (full swivel). 15" hose.

M IL:S516	DUAL HEAD STRAIGHT FOOT CHUCK WINDOW INFLATOR GAUGE..1 EACH	\$ 42.74
-----------	---	----------

Milton Bayonet Inflator Gauges

These heavy duty gauges will with stand everyday use and abuse and provide long service life. The first single replacement cartridge air line gauge. Lever action. 2 sides are calibrated for 10-120 PSI in 2lb increments and 2 sides are calibrated from 80-840 kPa in 20 kPa units.

Bayonet gauge with single head chuck

M IL:521	SINGLE HEAD CHUCK BAYONET INFLATOR GAUGE..1 EACH	\$ 32.44
----------	--	----------

Bayonet gauge with dual (truck) head chuck

M IL:S522	DUAL HEAD CHUCK BAYONET INFLATOR GAUGE..1 EACH	\$ 45.17
-----------	--	----------

Milton Repair Parts For Inflator Gauges

Dual head chuck (free flowing for tie gauges only)

M IL:500-4	INFLATOR GAUGE DUAL HEAD CHUCK..1 EACH	\$ 2.93
------------	--	---------

Standard size washer (for dual head chuck and straight head chuck)

M IL:500-6	INFLATOR GAUGE DUAL HEAD CHUCK WASHER..10 PER PACK	\$ 4.02
------------	--	---------

Standard size washer (for single head chuck)

M IL:500-7	INFLATOR GAUGE SINGLE HEAD CHUCK WASHER..10 PER PACK	\$ 0.28
------------	--	---------

Grip chuck (free flowing for tire gauges only)

M IL:500-43	INFLATOR GAUGE GRIP CHUCK..10 PER PACK	\$ 8.35
-------------	--	---------

M IL:500-45	INFLATOR GAUGE STRAIGHT HEAD CHUCK..1 EACH	\$ -
-------------	--	------

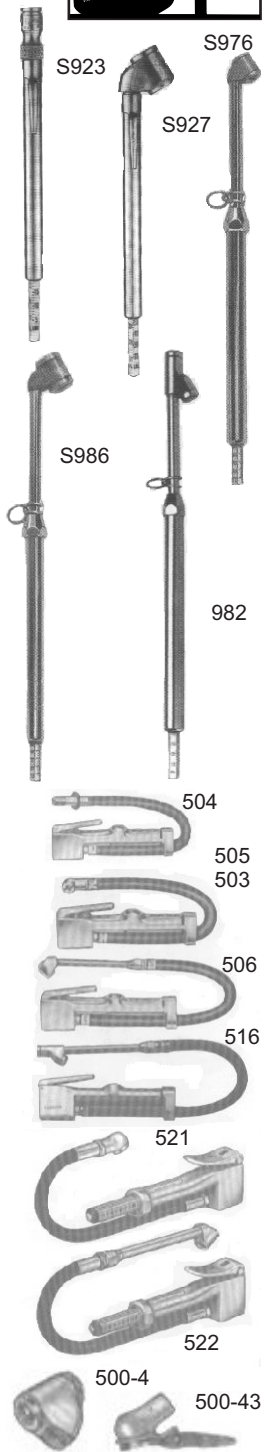



TIRE SUPPLIES

INFLATOR GAUGES & REPAIR PARTS

Milton Window Inflator Gauge Replacement Parts

Replacement gauge cartridge. Factory set cartridge easily replaced on the spot.

MIL:507	WINDOW INFLATOR GAUGE REPLACEMENT CARTRIDGE..1 EACH	\$ 12.59
---------	---	----------

Complete hose whip assembly. MIL 506 replacement hose. 15" hose. Threaded 3/8-24

MIL:509	WINDOW INFLATOR GAUGE DUAL HEAD CHUCK REPLACEMENT HOSE..1 EACH	\$ 14.40
---------	--	----------

Complete hose whip assembly. MIL 504 replacement hose. 15" hose. Threaded 3/8-24

MIL:510	WINDOW INFLATOR GAUGE STRAIGHT HEAD CHUCK REPLACEMENT HOSE..1 EACH	\$ 8.90
---------	--	---------

Complete hose whip assembly. MIL 503 replacement hose. 36" hose. Threaded 3/8-24

MIL:511	WINDOW INFLATOR GAUGE SINGLE HEAD CHUCK WITH CLIP REPLACEMENT HOSE..1 EACH	\$ 15.95
---------	--	----------

Replacement valve cartridge

MIL:512	WINDOW INFLATOR GAUGE REPLACEMENT VALVE CARTRIDGE..1 EACH	\$ 6.94
---------	---	---------

Milton Bayonet Inflator Gauge Replacement Parts

Replacement cartridge

MIL:525	BAYONET INFLATOR GAUGE REPLACEMENT CARTRIDGE..1 EACH	\$ 11.28
---------	--	----------

Complete hose assembly. MIL 522 replacement hose. 12" hose. Threaded 1/4NPT

MIL:527	BAYONET INFLATOR GAUGE DUAL HEAD CHUCK REPLACEMENT HOSE..1 EACH	\$ 11.38
---------	---	----------

Complete hose assembly. MIL 520 replacement hose. 12" hose. Threaded 1/4NPT

MIL:528	BAYONET INFLATOR GAUGE STRAIGHT CHUCK REPLACEMENT HOSE..1 EACH	\$ 8.68
---------	--	---------

Complete hose assembly. MIL 523 replacement hose. 36" hose. Threaded 1/4NPT

MIL:529	BAYONET INFLATOR GAUGE GRIP STYLE CHUCK REPLACEMENT HOSE..1 EACH	\$ 16.17
---------	--	----------

FLAT TIRE REPAIR

Solder Seal/Gunk Puncture Seal

SSG:M 11-14	PUNCTURE SEAL..14 OZ AEROSOL	\$ 3.33
SSG:M 11-18	PUNCTURE SEAL..18 OZ AEROSOL	\$ 5.00
SSG:M 11-28	PUNCTURE SEAL..24.5 OZ AEROSOL	\$ 7.50

Other Brands

PRI:S420	FIX A FLAT WITH HOSE..16 OZ AEROSOL	\$ 4.80
----------	-------------------------------------	---------

MISCELLANEOUS TIRE SUPPLIES

Berryman Tire Sealer

Used as a preventive measure, Berryman tire sealer protects off road tires from punctures up to 1/4 inch.

BER:1308	TIRE SEAL-R TIRE SEALANT ..8 OZ	\$ 3.98
BER:1316	TIRE SEAL-R TIRE SEALANT ..16 OZ	\$ 6.76
BER:1301	TIRE SEAL-R TIRE SEALANT WITH PUMP ..1 GAL	\$ 30.06

Other Brands

W/W:46056	OFF THE ROAD TIRE SEALER ..5 GAL	\$ 103.54
-----------	----------------------------------	-----------

Tire Mounting Compound

W/W:46632	TIRE MOUNTING COMPOUND ..8 LB	\$ 14.88
W/W:46633	TIRE MOUNTING COMPOUND ..25 LB	\$ 29.00

Rubber Lubricants

W/W:SUPER-SLICK	TIRE MOUNT LUBRICANT ..1 GAL	\$ 10.77
AGS:RG18	RUGLYDE RUBBER LUBRICANT ..1 GAL	\$ 14.83
AGS:SG8	SIL-GLYDE LUBRICANT COMPOUND ..8 OZ TUBE	\$ 11.78

Rim Protectors

TMR:T1182963	PLASTIC RIM PROTECTOR..1 EACH	\$ 3.48
--------------	-------------------------------	---------

Tire Marking Crayons

CAM :17-236	YELLOW TIRE CRAYON	\$ 0.62
CAM :17-235	WHITE TIRE CRAYON	\$ 0.75

Tread Depth Gauge

MIL:S448	TREAD DEPTH GAUGE..1 EACH	\$ 5.11
----------	---------------------------	---------

Bead Sealer

CAM :12-090	BEAD SEALER..1 QT CAN	\$ 24.77
W/W:BS32	BEAD SEALER..1 QT	\$ 10.28

Bead Expanders

CAM :18-287	STANDARD SIZE BEAD EXPANDER	\$ 116.53
-------------	-----------------------------	-----------



507



509

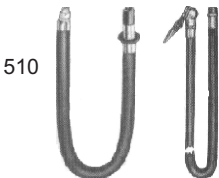

510



512

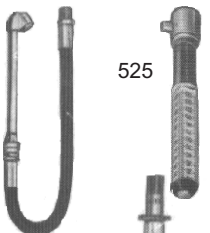

525

527

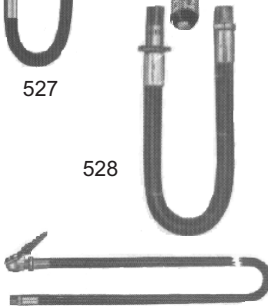

528



529



S448



TIRE SUPPLIES



ALIGNMENT SHIMS

Alignment Shims

HMC:N 18	1/8" ALIGNMENT SHIM ..25 PER BOX	\$ 2.40
HMC:N 116	1/16" ALIGNMENT SHIM ..25 PER BOX	\$ 1.73

WHEEL WEIGHT TOOL

Wheel Weight Tool

This tool is designed to hammer weight on and pull weights off.

W/W:25K	ALL PURPOSE WHEEL WEIGHT TOOL..1 EACH	\$ 12.31
HMC:00934	WEIGHT TOOL..1 EACH	\$ 32.99

WHEEL WEIGHTS

Stick-On Weights

HMC:7026	1/4 OZ STICK ON WEIGHTS..12 WEIGHTS PER STICK..30 STICKS PER BOX	\$ 36.33
----------	--	----------

T-Series

The T-series of weights is for use on all passenger car rims with 13" through 15" steel wheels except where there are full flush wheel covers. This design also replaces the 2-piece steel wheel design commonly found on European vehicles

HMC:T25	PASSENGER CAR WHEEL WEIGHTS..50 PER BOX	\$ 6.08
HMC:T50	PASSENGER CAR WHEEL WEIGHTS..50 PER BOX	\$ 8.23
HMC:T75	PASSENGER CAR WHEEL WEIGHTS..50 PER BOX	\$ 11.66
HMC:T100	PASSENGER CAR WHEEL WEIGHTS..50 PER BOX	\$ 11.21
HMC:T125	PASSENGER CAR WHEEL WEIGHTS..50 PER BOX	\$ 13.85
HMC:T150	PASSENGER CAR WHEEL WEIGHTS..50 PER BOX	\$ 17.58
HMC:T175	PASSENGER CAR WHEEL WEIGHTS..50 PER BOX	\$ 19.97
HMC:T200	PASSENGER CAR WHEEL WEIGHTS..50 PER BOX	\$ 25.36
HMC:T225	PASSENGER CAR WHEEL WEIGHTS..50 PER BOX	\$ 32.18
HMC:T250	PASSENGER CAR WHEEL WEIGHTS..50 PER BOX	\$ 35.06
HMC:T275	PASSENGER CAR WHEEL WEIGHTS..50 PER BOX	\$ 43.03
HMC:T300	PASSENGER CAR WHEEL WEIGHTS..50 PER BOX	\$ 41.47
HMC:T325	PASSENGER CAR WHEEL WEIGHTS..50 PER BOX	\$ 23.08
HMC:T350	PASSENGER CAR WHEEL WEIGHTS..50 PER BOX	\$ 24.40
HMC:T375	PASSENGER CAR WHEEL WEIGHTS..50 PER BOX	\$ 26.13
HMC:T400	PASSENGER CAR WHEEL WEIGHTS..50 PER BOX	\$ 27.76
HMC:T450	PASSENGER CAR WHEEL WEIGHTS..50 PER BOX	\$ 11.03
HMC:T500	PASSENGER CAR WHEEL WEIGHTS..50 PER BOX	\$ 33.18
HMC:T600	PASSENGER CAR WHEEL WEIGHTS..50 PER BOX	\$ 38.90

ALCEN-Series

The ALCEN-series of coated weights is recommended for wheels found on cars by : Acura, Honda, Mercedes-

HMC:ALCEN 10	COATED PASSENGER CAR WHEEL WEIGHTS..50 PER BOX	\$ 6.40
HMC:ALCEN 15	COATED PASSENGER CAR WHEEL WEIGHTS..50 PER BOX	\$ 9.73
HMC:ALCEN 20	COATED PASSENGER CAR WHEEL WEIGHTS..50 PER BOX	\$ 10.40
HMC:ALCEN 25	COATED PASSENGER CAR WHEEL WEIGHTS..50 PER BOX	\$ 13.75
HMC:ALCEN 30	COATED PASSENGER CAR WHEEL WEIGHTS..50 PER BOX	\$ 13.00
HMC:ALCEN 35	COATED PASSENGER CAR WHEEL WEIGHTS..50 PER BOX	\$ 12.98
HMC:ALCEN 40	COATED PASSENGER CAR WHEEL WEIGHTS..50 PER BOX	\$ 14.73
HMC:ALCEN 45	COATED PASSENGER CAR WHEEL WEIGHTS..50 PER BOX	\$ 14.88
HMC:ALCEN 50	COATED PASSENGER CAR WHEEL WEIGHTS..50 PER BOX	\$ 15.45

ALCLH-Series

The ALCLH-series of coated weights is recommended for late model Chrysler wheels

HMC:ALCLH25	COATED PASSENGER CAR WHEEL WEIGHTS..25 PER BOX	\$ 8.35
HMC:ALCLH50	COATED PASSENGER CAR WHEEL WEIGHTS..25 PER BOX	\$ 11.03
HMC:ALCLH75	COATED PASSENGER CAR WHEEL WEIGHTS..25 PER BOX	\$ 12.90
HMC:ALCLH100	COATED PASSENGER CAR WHEEL WEIGHTS..25 PER BOX	\$ 14.50
HMC:ALCLH125	COATED PASSENGER CAR WHEEL WEIGHTS..25 PER BOX	\$ 14.98
HMC:ALCLH150	COATED PASSENGER CAR WHEEL WEIGHTS..25 PER BOX	\$ 18.48
HMC:ALCLH175	COATED PASSENGER CAR WHEEL WEIGHTS..25 PER BOX	\$ 19.10
HMC:ALCLH200	COATED PASSENGER CAR WHEEL WEIGHTS..25 PER BOX	\$ 20.40
HMC:ALCLH225	COATED PASSENGER CAR WHEEL WEIGHTS..25 PER BOX	\$ 22.00
HMC:ALCLH250	COATED PASSENGER CAR WHEEL WEIGHTS..25 PER BOX	\$ 24.00

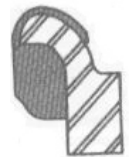



TIRE SUPPLIES

WHEEL WEIGHTS

MC-Series

The MC-series of weights is recommended for wheels found on cars by : AMC/Eagle, Buick, Cadillac, Chevrolet, Chrysler, Dodge, Ford, Lincoln, Mazda, Mercury, Mitsubishi, Oldsmobile, Plymouth , Pontiac, Saturn. (C designates a coated weight.)

HMC:ALCM C25	COATED PASSENGER CAR WHEEL WEIGHTS..50 PER BOX	\$ 6.11
HMC:ALCM C50	COATED PASSENGER CAR WHEEL WEIGHTS..50 PER BOX	\$ 8.34
HMC:ALCM C75	COATED PASSENGER CAR WHEEL WEIGHTS..50 PER BOX	\$ 9.68
HMC:ALCM C100	COATED PASSENGER CAR WHEEL WEIGHTS..50 PER BOX	\$ 10.99
HMC:ALCM C125	COATED PASSENGER CAR WHEEL WEIGHTS..50 PER BOX	\$ 13.87
HMC:ALCM C150	COATED PASSENGER CAR WHEEL WEIGHTS..50 PER BOX	\$ 14.41
HMC:ALCM C175	COATED PASSENGER CAR WHEEL WEIGHTS..50 PER BOX	\$ 14.88
HMC:ALCM C200	COATED PASSENGER CAR WHEEL WEIGHTS..50 PER BOX	\$ 16.03
HMC:ALCM C225	COATED PASSENGER CAR WHEEL WEIGHTS..50 PER BOX	\$ 17.28
HMC:ALCM C250	COATED PASSENGER CAR WHEEL WEIGHTS..25 PER BOX	\$ 18.35
HMC:ALCM C275	COATED PASSENGER CAR WHEEL WEIGHTS..25 PER BOX	\$ 19.40
HMC:ALCM C300	COATED PASSENGER CAR WHEEL WEIGHTS..25 PER BOX	\$ 20.18
HMC:ALM C25	UNCOATED PASSENGER CAR WHEEL WEIGHTS..50 PER BOX	\$ 4.80
HMC:ALM C50	UNCOATED PASSENGER CAR WHEEL WEIGHTS..50 PER BOX	\$ 5.98
HMC:ALM C75	UNCOATED PASSENGER CAR WHEEL WEIGHTS..50 PER BOX	\$ 8.11
HMC:ALM C100	UNCOATED PASSENGER CAR WHEEL WEIGHTS..50 PER BOX	\$ 9.20
HMC:ALM C125	UNCOATED PASSENGER CAR WHEEL WEIGHTS..50 PER BOX	\$ 13.86
HMC:ALM C150	UNCOATED PASSENGER CAR WHEEL WEIGHTS..50 PER BOX	\$ 14.40
HMC:ALM C175	UNCOATED PASSENGER CAR WHEEL WEIGHTS..50 PER BOX	\$ 15.07
HMC:ALM C200	UNCOATED PASSENGER CAR WHEEL WEIGHTS..50 PER BOX	\$ 15.85
HMC:ALM C225	UNCOATED PASSENGER CAR WHEEL WEIGHTS..50 PER BOX	\$ 16.25
HMC:ALM C250	UNCOATED PASSENGER CAR WHEEL WEIGHTS..25 PER BOX	\$ 16.30
HMC:ALM C275	UNCOATED PASSENGER CAR WHEEL WEIGHTS..25 PER BOX	\$ 20.25
HMC:ALM C300	UNCOATED PASSENGER CAR WHEEL WEIGHTS..25 PER BOX	\$ 22.13

C/X-Series

The C/X-series of weights is recommended for wheels found on cars by : Acura, AMC/Eagle, Buick, Cadillac, Chevrolet, Chrysler, Dodge, Geo, Infinity, Isuzu, Oldsmobile, Plymouth , Pontiac. (C designates a coated weight.)

HMC:ALC 25	COATED PASSENGER CAR WHEEL WEIGHTS..50 PER BOX	\$ 6.33
HMC:ALC 50	COATED PASSENGER CAR WHEEL WEIGHTS..50 PER BOX	\$ 8.48
HMC:ALC 75	COATED PASSENGER CAR WHEEL WEIGHTS..50 PER BOX	\$ 9.02
HMC:ALC 100	COATED PASSENGER CAR WHEEL WEIGHTS..50 PER BOX	\$ 8.48
HMC:ALC 125	COATED PASSENGER CAR WHEEL WEIGHTS..50 PER BOX	\$ 13.84
HMC:ALC 150	COATED PASSENGER CAR WHEEL WEIGHTS..50 PER BOX	\$ 14.00
HMC:ALC 175	COATED PASSENGER CAR WHEEL WEIGHTS..50 PER BOX	\$ 15.68
HMC:ALC 200	COATED PASSENGER CAR WHEEL WEIGHTS..50 PER BOX	\$ 15.64
HMC:ALC 225	COATED PASSENGER CAR WHEEL WEIGHTS..50 PER BOX	\$ 18.51
HMC:ALC 250	COATED PASSENGER CAR WHEEL WEIGHTS..25 PER BOX	\$ 17.83
HMC:ALC 275	COATED PASSENGER CAR WHEEL WEIGHTS..25 PER BOX	\$ 19.93
HMC:ALC 300	COATED PASSENGER CAR WHEEL WEIGHTS..25 PER BOX	\$ 20.83
HMC:ALX 25	UNCOATED PASSENGER CAR WHEEL WEIGHTS..50 PER BOX	\$ 10.46
HMC:ALX 50	UNCOATED PASSENGER CAR WHEEL WEIGHTS..50 PER BOX	\$ 12.18
HMC:ALX 75	UNCOATED PASSENGER CAR WHEEL WEIGHTS..50 PER BOX	\$ 16.00
HMC:ALX 100	UNCOATED PASSENGER CAR WHEEL WEIGHTS..50 PER BOX	\$ 19.43
HMC:ALX 125	UNCOATED PASSENGER CAR WHEEL WEIGHTS..50 PER BOX	\$ 21.83
HMC:ALX 150	UNCOATED PASSENGER CAR WHEEL WEIGHTS..50 PER BOX	\$ 25.99
HMC:ALX 175	UNCOATED PASSENGER CAR WHEEL WEIGHTS..50 PER BOX	\$ 26.38
HMC:ALX 200	UNCOATED PASSENGER CAR WHEEL WEIGHTS..50 PER BOX	\$ 28.95
HMC:ALX 225	UNCOATED PASSENGER CAR WHEEL WEIGHTS..50 PER BOX	\$ 34.33
HMC:ALX 250	UNCOATED PASSENGER CAR WHEEL WEIGHTS..50 PER BOX	\$ 37.35
HMC:ALX 275	UNCOATED PASSENGER CAR WHEEL WEIGHTS..50 PER BOX	\$ 40.40
HMC:ALX 300	UNCOATED PASSENGER CAR WHEEL WEIGHTS..50 PER BOX	\$ 44.23

MONDAY-FRIDAY
8am-5pm a helpful
HUMAN voice will
always answer the
phone
(770)474-1286

PARKER, BROTHERS, INC.

(770)474-1286

7-10

TIRE SUPPLIES



WHEEL WEIGHTS

CFN-Series

The CFN-series of coated weights is designed for the thicker flange alloy wheels being used on many Japanese vehicles. Acura, AMC/Eagle, Dodge, Honda, Geo, Infiniti, Lexus, Mazda, Nissan, Plymouth, Toyota.

HMC:ALCFN5	COATED PASSENGER CAR WHEEL WEIGHTS..50 PER BOX	\$ 8.52
HMC:ALCFN10	COATED PASSENGER CAR WHEEL WEIGHTS..50 PER BOX	\$ 9.43
HMC:ALCFN15	COATED PASSENGER CAR WHEEL WEIGHTS..50 PER BOX	\$ 11.62
HMC:ALCFN20	COATED PASSENGER CAR WHEEL WEIGHTS..50 PER BOX	\$ 12.63
HMC:ALCFN25	COATED PASSENGER CAR WHEEL WEIGHTS..50 PER BOX	\$ 12.83
HMC:ALCFN30	COATED PASSENGER CAR WHEEL WEIGHTS..50 PER BOX	\$ 13.16
HMC:ALCFN35	COATED PASSENGER CAR WHEEL WEIGHTS..50 PER BOX	\$ 14.01
HMC:ALCFN40	COATED PASSENGER CAR WHEEL WEIGHTS..50 PER BOX	\$ 14.73
HMC:ALCFN45	COATED PASSENGER CAR WHEEL WEIGHTS..50 PER BOX	\$ 15.03
HMC:ALCFN50	COATED PASSENGER CAR WHEEL WEIGHTS..50 PER BOX	\$ 15.48
HMC:ALCFN55	COATED PASSENGER CAR WHEEL WEIGHTS..50 PER BOX	\$ 15.85
HMC:ALCFN60	COATED PASSENGER CAR WHEEL WEIGHTS..50 PER BOX	\$ 16.13

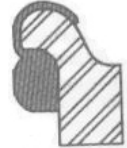

IW-Series

The IW-series of coated weights is used on many import car alloy wheels. AMC/Eagle, Audi, BMW, Chrysler, Dodge, Geo, Hyundai, Jaguar, Merkur, Mitsubishi, Nissan, Plymouth, Pontiac, Saab, Sterling, Subaru, Suzuki, Toyota, Volkswagen, Volvo. (C designates a coated weight.)

HMC:ALCIW5	COATED PASSENGER CAR WHEEL WEIGHTS..25 PER BOX	\$ 8.91
HMC:ALCIW10	COATED PASSENGER CAR WHEEL WEIGHTS..25 PER BOX	\$ 9.27
HMC:ALCIW15	COATED PASSENGER CAR WHEEL WEIGHTS..25 PER BOX	\$ 9.60
HMC:ALCIW20	COATED PASSENGER CAR WHEEL WEIGHTS..25 PER BOX	\$ 12.76
HMC:ALCIW25	COATED PASSENGER CAR WHEEL WEIGHTS..25 PER BOX	\$ 13.23
HMC:ALCIW30	COATED PASSENGER CAR WHEEL WEIGHTS..25 PER BOX	\$ 13.45
HMC:ALCIW35	COATED PASSENGER CAR WHEEL WEIGHTS..25 PER BOX	\$ 14.08
HMC:ALCIW40	COATED PASSENGER CAR WHEEL WEIGHTS..25 PER BOX	\$ 14.73
HMC:ALCIW45	COATED PASSENGER CAR WHEEL WEIGHTS..25 PER BOX	\$ 14.88
HMC:ALCIW50	COATED PASSENGER CAR WHEEL WEIGHTS..25 PER BOX	\$ 15.45
HMC:ALCIW55	COATED PASSENGER CAR WHEEL WEIGHTS..25 PER BOX	\$ 16.13
HMC:ALCIW60	COATED PASSENGER CAR WHEEL WEIGHTS..25 PER BOX	\$ 16.43
HMC:ALIW15	UNCOATED PASSENGER CAR WHEEL WEIGHTS..50 PER BOX	\$ 21.13
HMC:ALIW20	UNCOATED PASSENGER CAR WHEEL WEIGHTS..50 PER BOX	\$ 22.23
HMC:ALIW30	UNCOATED PASSENGER CAR WHEEL WEIGHTS..50 PER BOX	\$ 24.45

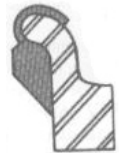

BTS-Series

The BTS-series of weights is used on light trucks, ¾ and 1 ton vehicles with either tube or tubeless rims.

HMC:BTS-1	LIGHT TRUCK WHEEL WEIGHTS..25 PER BOX	\$ 25.11
HMC:BTS-2	LIGHT TRUCK WHEEL WEIGHTS..25 PER BOX	\$ 25.35
HMC:BTS-3	LIGHT TRUCK WHEEL WEIGHTS..25 PER BOX	\$ 30.85
HMC:BTS-4	LIGHT TRUCK WHEEL WEIGHTS..25 PER BOX	\$ 60.70
HMC:BTS-6	LIGHT TRUCK WHEEL WEIGHTS..25 PER BOX	\$ 31.25
HMC:BTS-15	LIGHT TRUCK WHEEL WEIGHTS..25 PER BOX	\$ 20.55
HMC:BTS-5	LIGHT TRUCK WHEEL WEIGHTS..25 PER BOX	\$ 27.42



TLT-Series

The TLT-series of coated weights is used on Chevrolet, Ford and Dodge pick-up trucks.

HMC:TLTC25	COATED LIGHT TRUCK WHEEL WEIGHTS..25 PER BOX	\$ 16.63
HMC:TLTC50	COATED LIGHT TRUCK WHEEL WEIGHTS..25 PER BOX	\$ 18.50
HMC:TLTC75	COATED LIGHT TRUCK WHEEL WEIGHTS..25 PER BOX	\$ 20.38
HMC:TLTC100	COATED LIGHT TRUCK WHEEL WEIGHTS..25 PER BOX	\$ 22.63
HMC:TLTC125	COATED LIGHT TRUCK WHEEL WEIGHTS..25 PER BOX	\$ 27.05
HMC:TLTC150	COATED LIGHT TRUCK WHEEL WEIGHTS..25 PER BOX	\$ 29.85
HMC:TLTC175	COATED LIGHT TRUCK WHEEL WEIGHTS..25 PER BOX	\$ 30.63
HMC:TLTC200	COATED LIGHT TRUCK WHEEL WEIGHTS..25 PER BOX	\$ 32.65
HMC:TLTC225	COATED LIGHT TRUCK WHEEL WEIGHTS..25 PER BOX	\$ 34.58
HMC:TLTC250	COATED LIGHT TRUCK WHEEL WEIGHTS..25 PER BOX	\$ 36.58
HMC:TLTC275	COATED LIGHT TRUCK WHEEL WEIGHTS..25 PER BOX	\$ 38.73
HMC:TLTC300	COATED LIGHT TRUCK WHEEL WEIGHTS..25 PER BOX	\$ 40.48



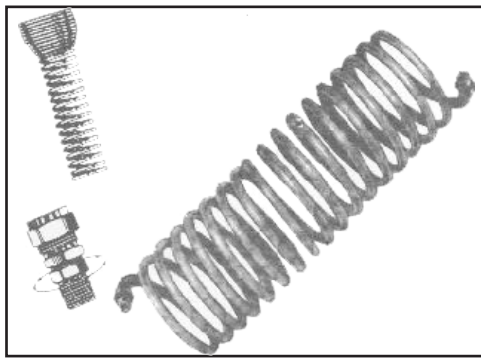

AIR HOSES AND FITTINGS

AIR HOSES
HOSE FITTINGS
AIR COUPLERS
BLOW GUNS
WATER SUPPLIES
FILTERS, REGULATORS, AND LUBRICATORS
AIR COUPLER INTERCHANGE

AIR HOSES AND FITTINGS

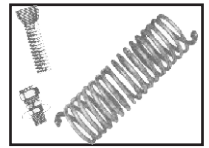

AIR HOSES

Gates Safety Stripe Air Hoses

These rugged air hoses are ideal for automotive shop use. They are made of heavy duty reinforced multiple layer fabrics. They are oil and abrasion resistant and come with a factory assembled 300psi male coupler.

GAT:27485	SAFETY STRIPE AIR HOSE..1/4" X 25'	\$ 23.50
GAT:27486	SAFETY STRIPE AIR HOSE..1/4" X 50'	\$ 40.18
GAT:27488	SAFETY STRIPE AIR HOSE..3/8" X 25'	\$ 27.95
GAT:27489	SAFETY STRIPE AIR HOSE..3/8" X 50'	\$ 58.83
GAT:27491	SAFETY STRIPE AIR HOSE..1/2" X 25'	\$ 34.59
GAT:27492	SAFETY STRIPE AIR HOSE..1/2" X 50'	\$ 92.56



Gates Charter Air Hoses

These rugged air hoses are ideal for automotive shop use. They are made of heavy duty reinforced fabrics. They are oil and abrasion resistant and come with a factory assembled 250psi male coupler.

GAT:27475	CHARTER AIR HOSE..1/4" X 25'	\$ 19.73
GAT:27476	CHARTER AIR HOSE..1/4" X 50'	\$ 33.37
GAT:27478	CHARTER AIR HOSE..3/8" X 25'	\$ 22.19
GAT:27479	CHARTER AIR HOSE..3/8" X 50'	\$ 49.28

Other Brands

W/H:HY0604OP	3/8" X 50' AIR HOSE	\$ 55.00
W/H:HY0604MP	3/8" X 100' AIR HOSE	\$ 103.44

Milton Recoil Air Hoses

Assembled with re-usable, full flow male NPT swivel fittings on both ends to avoid twisting and kinking. Individual display bag packaged. Resists abrasions. Maximum working pressure : 200PSI at 70F. Working temperature : -40F to 180F. (-38C to 82C). Material equivalent to Nylon 12. Color : yellow.

MIL:1667	1/4 NPT MALE THREADS - 1/4 ID..1 EACH	\$ 12.37
MIL:1669	25' RE-KOIL HOSE..1/4 NPT MALE THREADS - 1/4 ID ..1 EACH	\$ 18.87
MIL:1670	50' RE-KOIL HOSE..1/4 NPT MALE THREADS - 1/4 ID..1 EACH	\$ 28.54
MIL:1675	50' RE-KOIL HOSE..3/8 NPT MALE THREADS - 3/8 ID..1 EACH	\$ 49.37

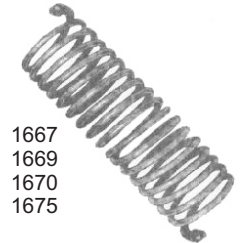

1667
1669
1670
1675



1675-1

HOSE FITTINGS

Milton Recoil Air Hose Swivel Ends

These are replacement fittings for nylon recoil hoses.

MIL:1669-1	SWIVEL HOSE END..1/4 NPT MALE THREADS - 1/4 ID..1 EACH	\$ 4.77
MIL:1669-2	REPAIR UNION..1/4 ID HOSE MENDER..1 EACH	\$ 3.91
MIL:1675-1	SWIVEL HOSE END..3/8 NPT MALE THREADS - 3/8 ID..1 EACH	\$ 6.94

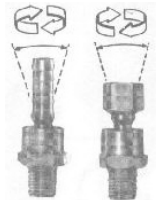

658 S659
658-1

Milton Full Swivel Hose Ends

These steel constructed 360 degree swivel ends help to eliminate kinked and twisted air hoses. They also deliver higher CFM's than other swivel ends. Black oxide finish.

MIL:658	FULL SWIVEL HOSE END..1/4 NPT MALE THREADS X 1/4 BARB..1 EACH	\$ 6.08
MIL:658-1	FULL SWIVEL HOSE END..1/4 NPT MALE THREADS X 3/8 BARB..1 EACH	\$ 6.18
MIL:659	FULL SWIVEL HOSE END..1/4 NPT MALE THREADS X 1/4 NPT FEMALE THREADS..1 EACH	\$ 0.84



605-1 600-4
605-2 S600
605-3 S663
S605 S601
S602
S603
604
604-1

Milton Brass Hose Ends

MIL:600-4	BRASS HOSE END 1/4 NPT MALE THREADS FOR 1/8 ID HOSE..1 EACH	\$ 1.13
MIL:S600	BRASS HOSE END 1/4 NPT MALE THREADS FOR 1/4 ID HOSE..2 PER CARD	\$ 2.13
MIL:S601	BRASS HOSE END 1/4 NPT MALE THREADS FOR 5/16 ID HOSE..2 PER CARD	\$ 2.13
MIL:S602	BRASS HOSE END 1/4 NPT MALE THREADS FOR 3/8 ID HOSE..2 PER CARD	\$ 2.64
MIL:S603	BRASS HOSE END 3/8 NPT MALE THREADS FOR 3/8 ID HOSE..2 PER CARD	\$ 2.64
MIL:604	BRASS HOSE END 3/8 NPT MALE THREADS FOR 1/2 ID HOSE..1 EACH	\$ 1.45
MIL:604-1	BRASS HOSE END 1/2 NPT MALE THREADS FOR 1/2 ID HOSE..1 EACH	\$ 2.39
MIL:605-1	BRASS HOSE END 1/4 NPT FEMALE THREADS FOR 5/16 ID HOSE..1 EACH	\$ 1.41
MIL:605-2	BRASS HOSE END 1/4 NPT FEMALE THREADS FOR 3/8 HOSE..1 EACH	\$ 1.30
MIL:605-3	BRASS HOSE END 3/8 NPT FEMALE THREADS FOR 3/8 ID HOSE..1 EACH	\$ 1.95
MIL:S605	BRASS HOSE END 1/4 NPT FEMALE THREADS FOR 1/4 ID HOSE..2 PER CARD	\$ 2.67

Milton Brass Ball Seat Swivel Hose Ends

MIL:S609	BRASS HOSE END SWIVEL BALL SEAT 1/4 NPS FEMALE THREADS 1/4 ID HOSE..2 PER CARD	\$ 3.04
MIL:610-1	BRASS HOSE END SWIVEL BALL SEAT 1/4 NPS FEMALE THREADS FOR 3/8 ID HOSE..1 EACH	\$ 1.37

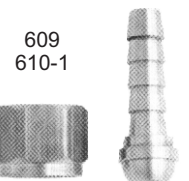

609
610-1



AIR HOSES AND FITTINGS

HOSE FITTINGS

Milton Re-Usable Brass Fittings

MIL:S615	REUSABLE BRASS HOSE FITTING 1/4 NPT MALE THREADS 1/4 ID 19/32 OR 9/16 OD..1EACH	\$ 2.82
MIL:S617	REUSABLE BRASS HOSE FITTING 1/4 NPT MALE THREADS 1/4 ID 5/8 OD HOSE..1EACH	\$ 4.23
MIL:616	REUSABLE BRASS HOSE MENDER 1/4 ID 19/32 OR 9/16 OD HOSE..1EACH	\$ 4.12
MIL:S618	REUSABLE BRASS HOSE MENDER 1/4 ID 5/8 OD HOSE..1EACH	\$ 5.43
MIL:S621	REUSABLE BRASS HOSE FITTING 1/4 NPT MALE THREADS 3/8 ID 3/4 OD HOSE..1EACH	\$ 4.01
MIL:S622	REUSABLE BRASS HOSE FITTING 3/8 NPT MALE THREADS 3/8 ID 11/16 OD HOSE..1EACH	\$ 12.15
MIL:623	REUSABLE BRASS HOSE MENDER 3/8 ID 3/4 OD HOSE..1EACH	\$ 5.97
MIL:625	REUSABLE BRASS HOSE FITTING 1/4 NPT FEMALE THREADS 1/4 ID 5/8 OD HOSE..1EACH	\$ 3.53

Milton Brass Hose Menders

MIL:640	BRASS HOSE MENDER 1/4 BARB X 1/4 BARB..1EACH	\$ 1.30
MIL:S641	BRASS HOSE MENDER 5/16 BARB X 5/16 BARB..2 PER CARD	\$ 2.60
MIL:S642	BRASS HOSE MENDER 3/8 BARB X 3/8 BARB..2 PER CARD	\$ 2.61
MIL:642-1	BRASS HOSE MENDER 1/2 BARB X 1/2 BARB..1EACH	\$ 1.55

Milton Zamak Alloys Hose Ends & Menders

MIL:S663	ZAMAK ALLOY HOSE END..1/4 NPT MALE THREADS X 1/4 BARB..2 PER CARD	\$ 11.61
MIL:S676	ZAMAK ALLOY HOSE MENDER..1/4 BARB X 1/4 BARB..2 PER CARD	\$ 12.04

Milton Air Hose Repair Kit

Everything you need to fix an air hose in the field. This kit contains : 1/4NPT female air chuck. 1/4ID barb X1/4NPT male hose end, 1/4ID barb x 1/4ID barb hose mender and 3 5/8OD hose clamps.

MIL:S620	1/4" HOSE REPAIR KIT..1 KIT	\$ 4.12
----------	-----------------------------	---------

Milton Brass Fittings

MIL:S643	FEMALE HEX COUPLING..1/4 NPT X 1/4 NPT..2 PER CARD	\$ 2.16
MIL:643-1	FEMALE HEX COUPLING..3/8 NPT X 1/4 NPT..1EACH	\$ 1.84
MIL:643-3	FEMALE HEX COUPLING ..3/8 NPT X 3/8 NPT..1EACH	\$ 1.95
MIL:643-4	FEMALE HEX COUPLING..1/2 NPT X 3/8 NPT..1EACH	\$ 2.39
MIL:S646	MALE HEX NIPPLE..1/4 NPT X 1/4 NPT..2 PER CARD	\$ 2.39
MIL:646-1	MALE HEX NIPPLE..1/4 NPT X 3/8 NPT..1EACH	\$ 1.55
MIL:647	MALE HEX NIPPLE..3/8 NPT X 3/8 NPT..1EACH	\$ 1.55
MIL:647-1	MALE HEX NIPPLE..3/8 NPT X 1/2 NPT..1EACH	\$ 2.45
MIL:S648	MALE HEX NIPPLE..1/4 NPT X 1/4 NPS BALL SOCKET..2 PER CARD	\$ 3.58
MIL:S649	MALE HEX NIPPLE..1/4 NPS X 1/4 NPS BALL SOCKET..1EACH	\$ 8.68

Milton Brass Reducer Bushings

MIL:650	BRASS REDUCER BUSHING..1/4 NPT MALE X 1/8 NPT FEMALE..1EACH	\$ 0.86
MIL:651	BRASS REDUCER BUSHING..3/8 NPT MALE X 1/4 NPT FEMALE..1EACH	\$ 1.42
MIL:651-1	BRASS REDUCER BUSHING..1/2 NPT MALE X 1/4 NPT FEMALE..1EACH	\$ 1.49
MIL:652	BRASS REDUCER BUSHING..1/2 NPT MALE X 3/8 NPT FEMALE..1EACH	\$ 1.49

Milton Brass Adapters

MIL:653	BRASS ADAPTER..1/8 NPT MALE X 1/4 NPT FEMALE..1EACH	\$ 1.84
MIL:653-2	BRASS ADAPTER..1/4 NPT MALE X 3/8 NPT FEMALE..1EACH	\$ 2.82
MIL:653-4	BRASS ADAPTER..3/8 NPT MALE X 1/2 NPT FEMALE..1EACH	\$ 2.82

Milton Brass T's

MIL:655	BRASS T..3 1/4NPT FEMALE INLETS..1EACH	\$ 6.08
---------	--	---------

Milton Air Hose Swivel Connector

Attach portable air tools to air hose. 360 degree swivel in two places prevent hose from kinking and keeps hose out of the way. Female pipe threads connect to most hose fittings and adapters. Not for use with percussion tools.

MIL:S657	AIR HOSE SWIVEL CONNECTOR..1/4 NPT MALE AND FEMALE THREADS..1EACH	\$ 1.78
----------	---	---------

Milton 3-in-1 Air Manifold

Supply 3 air tools from a single inlet. No need to disconnect and connect for every tool change.

MIL:S685-4	3 IN 1 AIR MANIFOLD..1/4 NPT FEMALE INLET X 3 1/4 NPT FEMALE OUTLETS..1EACH	\$ 5.75
MIL:S685-6	3 IN 1 AIR MANIFOLD..3/8 NPT FEMALE INLET X 3 1/4 NPT FEMALE OUTLETS..1EACH	\$ 4.67

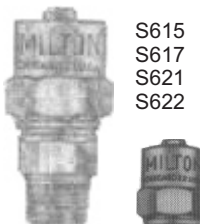
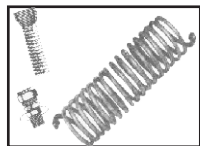

S615
S617
S621
S622



616
S618
623



640
S641
S642
624-1
676



S663



S643
643-1
643-3
643-4



S646
646-1
647



650
651
651-1
652



653
653-2
653-4



655

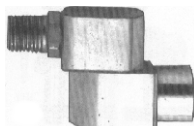

S657



S685-4
S685-6



PARKER, BROTHERS, INC.

AIR HOSES AND FITTINGS

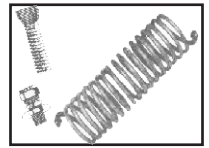

HOSE FITTINGS

Milton Swivel End Snubber Hoses

Absorb shock to air couplers from impact tools and air hammers. Snubber hoses are fitted with full 360 degree steel swivel fittings for greater flexibility and easier use. Burst pressure : 800PSI. Maximum working pressure : 200PSI

M IL:S680	30" SNUBBER HOSE..1/4 NPT THREADS 1/4 ID HOSE..1 EACH	\$ 16.82
M IL:S680-2	30" SNUBBER HOSE..1/4 NPT THREADS 3/8 ID HOSE..1 EACH	\$ 12.04
M IL:S680-3	5' SNUBBER HOSE..1/4 NPT THREADS 3/8 ID HOSE..1 EACH	\$ 16.81
M IL:681	2' SWIVEL END SNUBBER HOSE..3/8 NPT MALE THREADS 1/2 ID HOSE..1 EACH	\$ 7.27

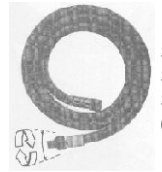

S680
S680-2
S680-3
681

Milton Tank Valve

M IL:S684	TANK VALVE 1/8 NPT MALE THREADS..2 PER CARD	\$ 9.11
-----------	---	---------



S684

Milton Tank Conversion Kit

Do it your self kit allows you to convert all no longer allowed R12 freon tanks to portable air tanks. WARNING -- NOT FOR PROPANE TANK CONVERSION. Kit includes : filler valve, gauge, 4' air hose assembly, manifold and chuck.

M IL:S682	R12 TO PORTABLE AIR TANK CONVERSION KIT..1 KIT	\$ 8.79
-----------	--	---------



S682

Milton Brass Hose Ferrules

Economical and dependable brass ferrules to make custom hose assemblies.

M IL:1654-6	BRASS HOSE FERRULE..1X .656 ID - HOSE OD 21/32..1 EACH	\$ 0.49
M IL:1654-7	BRASS HOSE FERRULE..1X .687 ID - HOSE OD 11/16..1 EACH	\$ 0.47
M IL:1654-9	BRASS HOSE FERRULE..1X .750 ID - HOSE OD 3/4..1 EACH	\$ 0.51



1654-7
1654-6
1654-9

AIR COUPLERS

Ten different coupler/plug styles are in current industrial and automotive use. They were originally developed by different manufacturers. There is no advantage of one style over the other, although styles M, H, and G are the most popular.

The size defines the air handling capacity of the coupler. The 1/4" is the most popular size and handles 35SCFM. The 3/8" handles 60SCFM. For air volumes above this amount, use the 1/2" size.

USE THESE FULL-SIZE DRAWINGS TO IDENTIFY AN UNKNOWN PLUG STYLE

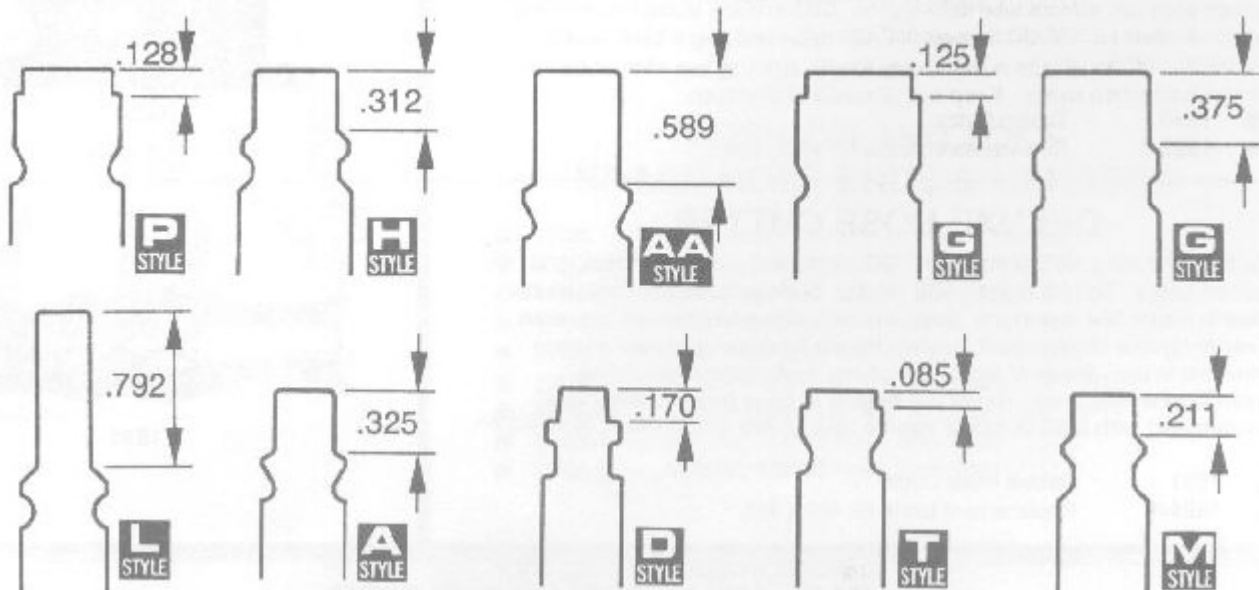

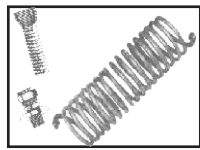

AIR HOSES AND FITTINGS

AIR COUPLERS

Milton M-Style Industrial Interchange Series 1/4" Basic Size

Milton M-style "kwik- change" couplers and plugs will interchange with all manufactures who comply with the dimensional requirements of military specification MIL-C-4109. M-style coupler bodies are brass with brass sleeves. M-style plugs are case hardened steel, plated to resist rust. Maximum inlet pressure : 300PSI. Maximum temperature : 250F. Air flow : 40 SCFM. Seals : Buna-N.

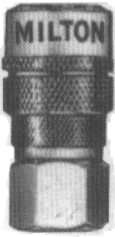

S715
718
S755

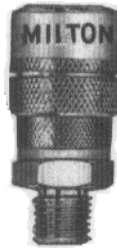

708
S716
719

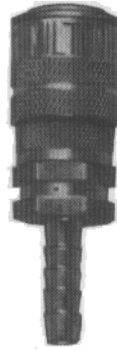

717
717-6



726
727
733



728
729
732



736
736-6

M-Style Combination Coupler/Plug

MIL:S711	M STYLE COUPLER AND PLUG COMBO..(1) MIL 727 AND (1) MIL S715..1EACH	\$ 5.00
----------	---	---------

M-Style Couplers

MIL:708	M STYLE COUPLER BODY..1/8 NPT MALE THREADS..1EACH	\$ 4.01
MIL:S715	M STYLE COUPLER BODY..1/4 NPT FEMALE THREADS..1EACH	\$ 5.93
MIL:S716	M STYLE COUPLER BODY..1/4 NPT MALE THREADS..1EACH	\$ 4.13
MIL:717	M STYLE COUPLER BODY..1/4 ID BARB..1EACH	\$ 5.64
MIL:717-6	M STYLE COUPLER BODY..3/8 ID BARB..1EACH	\$ 5.21
MIL:718	M STYLE COUPLER BODY..3/8 NPT FEMALE THREADS..1EACH	\$ 6.75
MIL:719	M STYLE COUPLER BODY..3/8 NPT MALE THREADS..1EACH	\$ 0.93
MIL:S755	M STYLE COUPLER BODY..PUSH/PULL TYPE..1/4 NPT FEMALE THREADS..1EACH	\$ 5.27

M-Style Plugs

MIL:726	M STYLE COUPLER PLUG..1/8 NPT MALE THREADS..1EACH	\$ 0.88
MIL:727	M STYLE COUPLER PLUG..1/4 NPT MALE THREADS..1EACH	\$ 0.92
MIL:728	M STYLE COUPLER PLUG..1/4 NPT FEMALE THREADS..1EACH	\$ 0.97
MIL:729	M STYLE COUPLER PLUG..1/8 NPT FEMALE THREADS..1EACH	\$ 1.55
MIL:732	M STYLE COUPLER PLUG..3/8 NPT FEMALE THREADS..1EACH	\$ 1.55
MIL:733	M STYLE COUPLER PLUG..3/8 NPT MALE THREADS..1EACH	\$ 1.55
MIL:736	M STYLE COUPLER PLUG..1/4 ID BARB..1EACH	\$ 1.84
MIL:736-6	M STYLE COUPLER PLUG..3/8 ID BARB..1EACH	\$ 4.63

M-Style Replacement Parts

MIL:701	M STYLE COUPLER REPAIR KIT..1KIT	\$ 3.85
MIL:768	M STYLE SYNTHETIC WASHER..1EACH	\$ 2.05



PARKER, BROTHERS, INC.
PARKER, BROTHERS, INC.
PARKER, BROTHERS, INC.

AIR HOSES AND FITTINGS

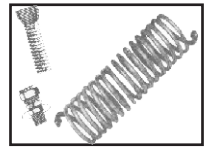

AIR COUPLERS

Milton H-Style Industrial Interchange Series 3/8" Basic Size

H-style coupler bodies are steel, plated to resist rust. H-style plugs are case hardened steel, plated to resist rust. Maximum inlet pressure : 300PSI. Maximum temperature : 250F. Air flow : 67 SCFM. Seals : Buna-N

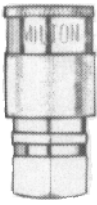

1833
1835

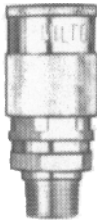

1836

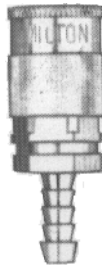

1836-6



1837
S1839



1838
1840



1837-6

H-Style Couplers

MIL:1833	H STYLE COUPLER BODY..1/4 NPT FEMALE THREADS..1 EACH	\$ 8.57
MIL:1835	H STYLE COUPLER BODY..3/8 NPT FEMALE THREADS..1 EACH	\$ 8.57
MIL:1836	H STYLE COUPLER BODY..3/8 NPT MALE THREADS..1 EACH	\$ 7.60
MIL:1836-6	H STYLE COUPLER BODY..3/8 ID BARB..1 EACH	\$ 8.57

H-Style Plugs

MIL:1837	H STYLE COUPLER PLUG..3/8 NPT MALE THREADS..1 EACH	\$ 1.52
MIL:1838	H STYLE COUPLER PLUG..3/8 ID BARB..1 EACH	\$ 1.58
MIL:S1839	H STYLE COUPLER PLUG..1/4 NPT MALE THREADS..2 PER CARD	\$ 8.19
MIL:1840	H STYLE COUPLER PLUG..1/4 NPT FEMALE THREADS..1 EACH	\$ 1.58
MIL:1837-6	H STYLE COUPLER PLUG..3/8 ID BARB..1 EACH	\$ 2.39



Milton G-Style Industrial Interchange Series 1/2" Basic Size

G-style coupler bodies are steel, plated to resist rust. G-style plugs are case hardened steel, plated to resist rust. Maximum inlet pressure : 300PSI. Maximum temperature : 250F. Air flow : 99 SCFM. Seals : Buna-N

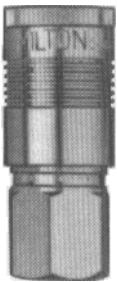

1813
1815

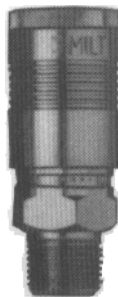

1814
S1816



1855
1857
1859



1858
1860



S1817
1819



S1818
1820

G-Style Couplers

MIL:1813	G STYLE COUPLER BODY..3/8 NPT FEMALE THREADS..1 EACH	\$ 13.85
MIL:1815	G STYLE COUPLER BODY..1/2 NPT FEMALE THREADS..1 EACH	\$ 15.34
MIL:S1816	G STYLE COUPLER BODY..1/2 NPT MALE THREADS..1 EACH	\$ 15.56

G-Style Tru-flate/Parker Plugs

MIL:S1817	G STYLE COUPLER PLUG..1/2 NPT MALE THREADS..1 EACH	\$ 2.86
MIL:S1818	G STYLE COUPLER PLUG..1/2 NPT FEMALE THREADS..1 EACH	\$ 3.24
MIL:1819	G STYLE COUPLER PLUG..3/8 NPT MALE THREADS..1 EACH	\$ 3.19
MIL:1820	G STYLE COUPLER PLUG..3/8 NPT FEMALE THREADS..1 EACH	\$ 2.67

G-Style Industrial Plugs

MIL:1855	G STYLE COUPLER PLUG..1/4 NPT MALE THREADS..1 EACH	\$ 3.14
MIL:1857	G STYLE COUPLER PLUG..1/2 NPT MALE THREADS..1 EACH	\$ 2.67
MIL:1858	G STYLE COUPLER PLUG..1/2 NPT FEMALE THREADS..1 EACH	\$ 3.02
MIL:1859	G STYLE COUPLER PLUG..3/8 NPT MALE THREADS..1 EACH	\$ 2.64
MIL:1860	G STYLE COUPLER PLUG..3/8 NPT FEMALE THREADS..1 EACH	\$ 2.83

FOR 50+ YEARS,
PARKER
BROTHERS
HAS BEEN
SERVING ATLANTA.
THANK YOU FOR
YOUR CONTINUED
SUPPORT!!

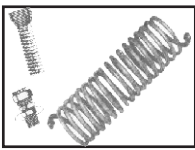

AIR HOSES AND FITTINGS

AIR COUPLERS

Milton A-Style Aro "210" Style Series 1/4" Basic Size

A-style couplers are push type. A-style coupler bodies are steel, plated to resist rust. A-style plugs are case hardened steel, plated to resist rust. Maximum inlet pressure : 300PSI. Maximum temperature : 250F. Air flow : 34 SCFM. Seals : Buna-N

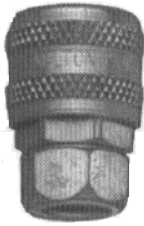

S775



S776



S777



S778



A-Style Couplers

MIL:S775	A STYLE COUPLER BODY..1/4 NPT FEMALE THREADS..1 EACH	\$ 6.21
MIL:S776	A STYLE COUPLER BODY..1/4 NPT MALE THREADS..1 EACH	\$ 5.60

A-Style Plugs

MIL:S777	A STYLE COUPLER PLUG..1/4 NPT MALE THREADS..2 PER CARD	\$ 2.32
MIL:S778	A STYLE COUPLER PLUG..1/4 NPT FEMALE THREADS..2 PER CARD	\$ 2.30

Milton T-Style Tru-flate/Parker Interchange Series 1/4" Basic Size

T-style couplers bodies are brass..T-style plugs are case hardened steel, plated to resist rust. Maximum inlet pressure : 300PSI. Maximum temperature : 250F. Air flow : 40 SCFM. Seals : Buna-N

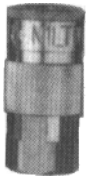

S785

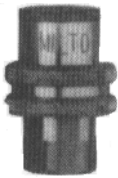

787

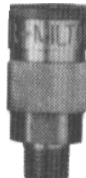

S786



S783



S784



780

T-Style Couplers

MIL:S785	T STYLE COUPLER BODY..1/4 NPT FEMALE THREADS..1 EACH	\$ 7.75
MIL:S786	T STYLE COUPLER BODY..1/4 NPT MALE THREADS..1 EACH	\$ 2.86
MIL:787	T STYLE COUPLER BODY..WITH OVERSIZE SLEEVE RING..1/4 NPT FEMALE THREADS..1 EACH	\$ 1.48

T-Style Plugs

MIL:780	T STYLE COUPLER PLUG..RE-CAPPER PLUG...482" - 26 FEMALE THREADS..1 EACH	\$ 5.46
MIL:S783	T STYLE COUPLER PLUG..1/4 NPT MALE THREADS..2 PER CARD	\$ 3.41
MIL:S784	T STYLE COUPLER PLUG..1/4 NPT FEMALE THREADS..2 PER CARD	\$ 5.46



Milton P-Style Tru-flate/Parker Interchange Series 3/8" Basic Size

P-style couplers bodies are heavy duty steel..P-style plugs are case hardened steel, plated to resist rust. Bodies have 8 locking balls. Maximum inlet pressure : 300PSI. Maximum temperature : 250F. Air flow : 68 SCFM. Seals : Buna-N

S1803
1805

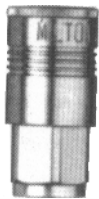

1806

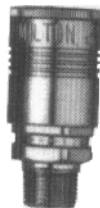

1807
1809



S1808
1810



P-Style Couplers

MIL:S1803	P STYLE COUPLER BODY..1/4 NPT FEMALE THREADS..1 EACH	\$ 8.51
MIL:1805	P STYLE COUPLER BODY..3/8 NPT FEMALE THREADS..1 EACH	\$ 8.14
MIL:1806	P STYLE COUPLER BODY..3/8 NPT MALE THREADS..1 EACH	\$ 8.14

P-Style Plugs

MIL:1807	P STYLE COUPLER PLUG..3/8 NPT MALE THREADS..1 EACH	\$ 1.59
MIL:S1808	P STYLE COUPLER PLUG..3/8 NPT FEMALE THREADS..2 PER CARD	\$ 3.26
MIL:1809	P STYLE COUPLER PLUG..1/4 NPT MALE THREADS..1 EACH	\$ 1.49
MIL:1810	P STYLE COUPLER PLUG..1/4 NPT FEMALE THREADS..1 EACH	\$ 1.69

MONDAY-FRIDAY
8am-5pm a helpful
HUMAN voice will
always answer the
phone
(770)474-1286

(770)474-1286

AIR HOSES AND FITTINGS

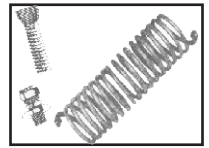

AIR COUPLERS

Milton L-Style Lincoln Interchange Series 1/4" Basic Size

L-style couplers are push type. L-style coupler bodies are steel, plated to resist rust. L-style plugs are case hardened steel, plated to resist rust. Maximum inlet pressure : 300PSI. Maximum temperature : 250F. Air flow : 32 SCFM. Seals : Buna-N



S790



S791



792

Parker Brothers
gladly accepts
Visa, Mastercard
Discover &
American Express

L-Style Couplers

MIL:S790	L STYLE COUPLER BODY..1/4 NPT FEMALE THREADS..1 EACH	\$ 7.75
----------	--	---------

L-Style Plugs

MIL:S791	L STYLE COUPLER PLUG..1/4 NPT MALE THREADS..2 PER CARD	\$ 3.20
MIL:792	L STYLE COUPLER PLUG..1/4 NPT FEMALE THREADS..1 EACH	\$ 6.48

Milton D-Style Diamond-U Interchange Series 1/4" Basic Size

D-style coupler bodies are steel, plated to resist rust. D-style plugs are case hardened steel, plated to resist rust. Maximum inlet pressure : 300PSI. Maximum temperature : 250F. Air flow : 34 SCFM. Seals : Buna-N



795



796



797



798

D-Style Couplers

MIL:795	D STYLE COUPLER BODY..1/4 NPT FEMALE THREADS..1 EACH	\$ 6.17
MIL:796	D STYLE COUPLER BODY..1/4 NPT MALE THREADS..1 EACH	\$ 1.51

D-Style Plugs

MIL:797	D STYLE COUPLER PLUG..1/4 NPT MALE THREADS..1 EACH	\$ 1.51
MIL:798	D STYLE COUPLER PLUG..1/4 NPT FEMALE THREADS..1 EACH	\$ 68.20

Milton V-Style

V-style couplers are designed for HVLP applications. They are push type couplers. Maximum inlet pressure : 300PSI. Maximum temperature : 250F. Air flow : 74 SCFM. Seals : Buna-N

V-Style Couplers

MIL:764	V-STYLE COUPLER BODY..1/4 NPT FEMALE THREADS..1 EACH	\$ 4.63
MIL:765	V-STYLE COUPLER BODY..1/4 NPT MALE THREADS..1 EACH	\$ 0.33

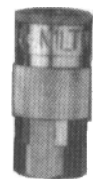

764

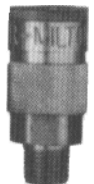

765

BLOW GUNS

Milton Blow Guns are indispensable for cleaning fuel and oil lines, air cleaners and car interiors, drying out wet ignition systems and spark plugs, blowing out dust dirt, filings, and metal chips. They have hundreds of other uses.

Milton Safety Blow Guns

Compact hand held unit can be used anywhere with compressed air. Streamlined comfort fit and full volume control. Many uses such as : cleaning fuel and oil lines, drying out wet ignition systems and spark plugs or blowing out dirt filings and metal chips. Maximum working pressure : 150PSI. Maximum nozzle pressure : 30PSI when dead ended. 11.4 SCFM @ 100PSI. 1/4NPT air inlet. Nozzle thread : 5/16-24. Zinc die cast body. OSHA compliant.

MIL:107	SAFETY BLOW GUN..1 EACH	\$ 6.40
---------	-------------------------	---------

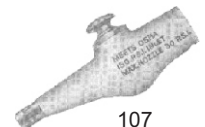

107

AIR HOSES AND FITTINGS

BLOW GUNS

Milton Safety Blow Guns

Use anywhere with compressed air. Full flow control. Extra large hang up easy storage. Maximum inlet pressure : 150PSI. Maximum nozzle pressure : 30PSI when dead ended. 10.6 SCFM @ 100PSI. 1/4NPT air inlet. Nozzle thread : 1/8-27. Zinc die cast body. Steel plated handle. OSHA compliant.

MIL:S120	LEVER HOOK SAFETY BLOW GUN..1 EACH	\$ 9.33
----------	------------------------------------	---------

Four safety by-pass holes allow air to escape if tip is blocked. By-pass holes do not interfere with normal air flow. Special internal design permits a restricted maximum discharge of 30PSI. Discharge same air volume as full flow blo-guns while maintaining required noise level and nozzle pressure. #133 and #134 are bent to a special angle to clean out blind holes and offer convenient use on long reach applications. Maximum inlet pressure : 150PSI. 4.5 SCFM @ 100PSI. 1/4NPT air inlet. Nozzle thread : 1/2-27. Zinc alloy body. OSHA compliant.

MIL:133	SAFETY BLOW GUN WITH 10" EXTENSION..1 EACH	\$ 15.52
---------	--	----------

MIL:134	SAFETY BLOW GUN WITH 15" EXTENSION..1 EACH	\$ 17.36
---------	--	----------

Compact and versatile blo-gun comes with both a safety nozzle and a rubber tip nozzle. Hang up hook for easy storage. Maximum working pressure : 150PSI. 11.7 SCFM @ 100PSI safety tip. 12.9 SCFM @ 100PSI rubber tip. 1/4NPT air inlet. Nozzle thread : 1/2-27. Zinc alloy body. OSHA compliant with safety tip only.

MIL:S148	COMPACT SAFETY LEVER BLOW GUN..1 EACH	\$ 7.65
----------	---------------------------------------	---------

Full flow safety lever blo-gun. Maximum working pressure : 150PSI. 10.0 SCFM @ 100PSI. 1/4NPT air inlet. Nozzle thread : 7/16-27. Body outlet thread size : 1/2-27. OSHA compliant.

MIL:S150	SAFETY LEVER BLOW GUN..1 EACH	\$ 3.36
----------	-------------------------------	---------

OSHA approved multi-function blo-gun comes with both a safety nozzle and a rubber tip nozzle. Extension is bent to access hard to reach places such as : motors, machinery, transmissions, combines and hidden areas. Maximum working pressure : 150PSI. 10.5 SCFM @ 100PSI safety nozzle. 11.6 SCFM @ 100PSI rubber tip nozzle. 1/4NPT air inlet. OSHA compliant with safety tip only.

MIL:158	BLOW GUN WITH 2' EXTENSION..1 EACH	\$ 18.99
---------	------------------------------------	----------

MIL:159	BLOW GUN WITH 4' EXTENSION..1 EACH	\$ 22.79
---------	------------------------------------	----------

Milton Non-Safety Blow Guns

For instant use, just press nozzle into air chuck.

MIL:S112	AIR CHUCK NOZZLE..1 EACH	\$ 53.17
----------	--------------------------	----------

Adjustable aluminum pocket blo-gun. Easy grip, two finger control to adjust from full volume air flow to complete shut off. Knurled grip for secure handling even with oily or greasy fingers. Always keep one handy with included shirt pocket clip. Different models to fit popular coupler interchange styles.

MIL:S115	ADJUSTABLE POCKET BLOW GUN..1 EACH	\$ 4.99
----------	------------------------------------	---------

MIL:S116	A STYLE POCKET BLOW GUN..1 EACH	\$ 9.66
----------	---------------------------------	---------

For use where leak proof connection is required when blowing out fluid lines. O-ring seal creates an air tight connection. A must where metal tip could mar delicate finishes in mold or paint.

MIL:S152	RUBBER TIP FOR BLOW GUN..1 EACH	\$ 9.98
----------	---------------------------------	---------

Rubber tip lever blo-gun. #S154 has a 45 degree bend ideal for automatic transmissions. Maximum working pressure : 150PSI. 11.4 SCFM @ 100PSI. 1/4NPT air inlet.

MIL:S153	RUBBER TIP BLOW GUN..1 EACH	\$ 13.32
----------	-----------------------------	----------

MIL:S154	RUBBER TIP LEVER BLOW GUN..1 EACH	\$ 12.37
----------	-----------------------------------	----------

Pistol style multi-use blo-gun. Accept #122 6" extension or #123 10" extension. Maximum working pressure : 150PSI. 10.0 SCFM @ 100PSI. 1/4NPT air inlet. Nozzle thread : 1/8-27. Zinc die cast, chrome plated body.

MIL:S160	PISTOL GRIP BLOW GUN..1 EACH	\$ 8.51
----------	------------------------------	---------

Milton Siphon Spray Blo-Guns

O-ring seal creates air tight connection. Dual thread design permits use on all blo-guns with 7/16-27 and 1/8NPS

MIL:155	SIPHON SPRAY NOZZLE..1 EACH	\$ 4.45
---------	-----------------------------	---------

Excellent for degreasing engines, garage bays and parts, spraying down livestock, plants and flowers. Perfect for rust proofing tools and machinery and lubricating parts and engines. #S157 kit comes with : S156 blo-gun, 8' tubing and display vinyl storage pouch. #161 kit comes with : S156 blo-gun, 12' tubing and 2' extension. Maximum working pressure : 150PSI. 14.0 SCFM @ 100PSI. 1/4NPT air inlet.

MIL:S156	SIPHON SPRAY BLOW GUN..1 EACH	\$ 17.36
----------	-------------------------------	----------

MIL:S157	SIPHON SPRAY BLOW GUN..WITH 8' OF TUBING..1 EACH	\$ 14.76
----------	--	----------

MIL:161	SIPHON BLOW KIT WITH 2' EXTENSION AND 12' OF TUBING..1 EACH	\$ 22.46
---------	---	----------

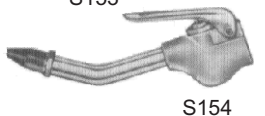
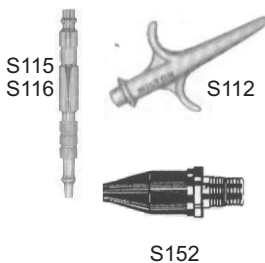
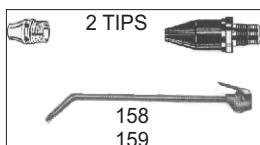
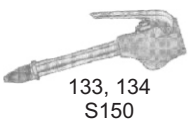
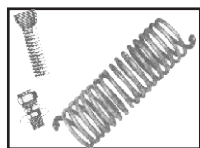

AIR HOSES AND FITTINGS

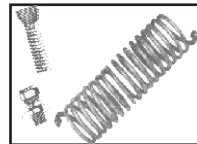

WATER SUPPLIES

Milton Filler Faucets

These tough faucets come with a long flexible rubber spout and positive lever control with stainless steel springs. They deliver a smooth flow of water to make operations easier. Operating pressure : municipal (city) water pressure 30 to 35PSI. Nitrile rubber. Zinc alloy body

M IL:208	FILLER FAUCET..3/4" GARDEN HOSE THREADS..1 EACH	\$ 13.45
M IL:209	FILLER FAUCET..1/4" NPT..1 EACH	\$ 11.72

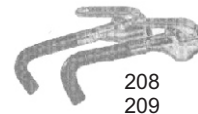

208
209

Milton Drain Cocks

These drain cocks have brass bodies and steel handles.

M IL:614-2	1/8 DRAIN COCK..1 EACH	\$ 1.19
M IL:S614-4	1/4 DRAIN COCK..2 PER CARD	\$ 2.71
M IL:614-6	3/8 DRAIN COCK..1 EACH	\$ 3.36
M IL:614-8	1/2 DRAIN COCK..1 EACH	\$ 4.23

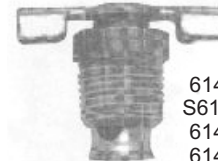

614-2
S614-4
614-6
614-8

Milton Water Hose Kwik Couplers

M IL:1890	BRASS WATER HOSE ..KWIK COUPLER SET..1 EACH	\$ 7.11
-----------	---	---------

FILTERS, REGULATORS, AND LUBRICATORS

Milton Micro Filters

All micro filters are supplied with preassembled AUTOMATIC OVERNIGHT DRAINS. Porous bronze 40 micron filter element allows less pressure drop and longer cleaning intervals. Safety metal bowl guards or metal bowls available with 1/4", 3/8" and 1/2" models. Metal bowls only with 3/4" and 1" models. 3 stage baffle system for exceptional moisture removal. Sintered bronze element are permanent and cleanable. Light weight aluminum die-cast housing. Element range : 10 to 40 microns exactly matching filter and air flow needs. Corrosion resistant metal bowls. 1022-8 and 1122-8 include sight glass for visual check of condensation collection. POLYCARBONATE BOWLS WITH METAL BOWL GUARD. 5oz. bowls. Maximum pressure : 150PSI. Temperature range 40 to 120F.

M IL:1018	1/4 NPT AIR LINE FILTER..1 EACH	\$ 40.04
M IL:1019	3/8 NPT AIR LINE FILTER..1 EACH	\$ 40.04
M IL:1020	1/2 NPT AIR LINE FILTER..1 EACH	\$ 41.01

HEAVY DUTY METAL BOWLS. 1120-8 90oz. bowl. 1122-8 29oz. bowl. Maximum pressure : 250PSI. Temperature range : 40 to 120F.

M IL:1120-8	1/2 NPT AIR LINE FILTER ..WITH METAL BOWL..1 EACH	\$ 63.69
M IL:1122-8	1" NPT AIR LINE FILTER ..WITH METAL BOWL..1 EACH	\$ 108.50

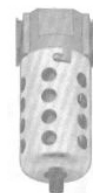

1018
1019
1020



1120-8

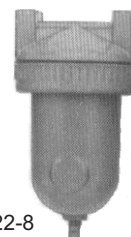

1122-8

Other Brands

N/S:1559A	MINI AIR LINE FILTER..1 EACH	\$ 37.94
-----------	------------------------------	----------

Milton Regulators

The MILTON heavy duty and mid-size RELIEVING TYPE regulators offer stable downstream air pressure over a wide range of air flows with accurate control, fast response and minimal pressure drop. Off set 1/4" gauge ports can also serve as two 1/4" supply lines, allowing up to three regulated full flow out ports. Inlet pressure : 250PSI. Operating temperature :40 to 120F. Aluminum die-cast body. Buna-N diaphragm and o-ring. Balanced piston. Molded rubber seat.

5 - 125PSI REGULATORS

M IL:1113	5 - 125 PSI REGULATOR..1/4 NPT..1 EACH	\$ 39.71
M IL:1114	5 - 125 PSI REGULATOR..3/8 NPT..1 EACH	\$ 39.71
M IL:1015	5 - 125 PSI REGULATOR..1/2 NPT..1 EACH	\$ 43.39

10 - 250PSI HI PRESSURE REGULATORS

M IL:1113-8	10 - 250 PSI REGULATOR..1/4 NPT..1 EACH	\$ 42.97
-------------	---	----------

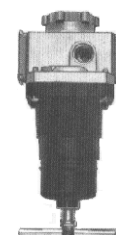

1113
1114
1115
1113-8

Milton Heavy Duty Regulators

Ideal for air flow applications that call for a compact unit, such as small pneumatic equipment, miniature valves and instruments. Gauge not included but available as an accessory. Relieving model : 5 - 125PSI. Maximum inlet pressure: 250PSI. Maximum operating temperature : 120F. Maximum SCFM : 25. 1/8NPT Gauge port.

M IL:S1145	MINI HEAVY DUTY REGULATOR..1/4 NPT..1 EACH	\$ 4.99
------------	--	---------

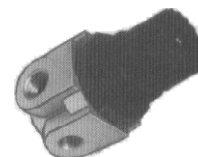

S1145

Milton In-Line Air Flow Regulators

To regulate air flow to air tools from full flow to complete shut off. Use as shut off valve for air and non-corrosive liquids. Maximum inlet pressure: 150PSI. Temperature range : 40 to 250F. 5 SCFM @ 100PSI.

M IL:S638	IN LINE AIR FLOW REGULATOR 1/4 NPT MALE & FEMALE THREADS..1 EACH	\$ 21.27
M IL:S638-1	IN LINE AIR FLOW REGULATOR WITH GAUGE 1/4 NPT MALE & FEMALE THREADS..1 EACH	\$ 16.17
M IL:638-7	0-160 PSI IN LINE AIR FLOW REGULATOR GAUGE...1/8-27 NPT MALE THREADS..1 EACH	\$ 10.09



S638-1
638-7

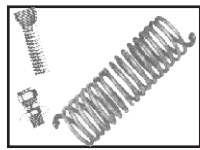

AIR HOSES AND FITTINGS

FILTERS, REGULATORS, AND LUBRICATORS

Milton Full Port Brass Ball Valve

These high capacity ball valves are designed for use with compressed air, water or oil to isolated segments of the system without disrupting service to the rest of the system. All brass bodies with plated steel ball, teflon seals and plated 1/4 handle. Maximum working pressure air, water and oil : 400PSI. Maximum working pressure steam : 150PSI. Temperature range : -20 to 350F.

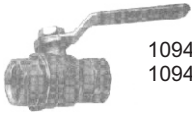

1094-6
1094-8

1 3/4" Body. Maximum pressure @ 210F : 260PSI

MIL:1094-6	BRASS BALL VALVE..BOTH ENDS 3/8 NPT FEMALE THREADS..1 EACH	\$ 11.07
------------	--	----------

2 1/2" Body. Maximum pressure @ 210F : 250PSI

MIL:1094-8	BRASS BALL VALVE..BOTH ENDS 1/2 NPT FEMALE THREADS..1 EACH	\$ 11.72
------------	--	----------

Milton Pressure Gauges

High quality dry gauge for reliable service with compressors, filter-regulator-lubricators, air lines and pneumatic tools and equipment. Resistant to heat, corrosion, water, salt water and oil. Can be used in steam applications if less than 120F. Brass mechanism. ABS case. Polycarbonate lens. Maximum working pressure : limited to 75% of dial range. Temperature range : -13 to 120F. 1/4NPT. 2" face.



1191
1192
1193
1194
1195

MIL:1191	0-60 PSI PRESSURE GAUGE..1/4 NPT MALE THREADS..MOUNTS CENTER BACK..1 EACH	\$ 10.85
MIL:1192	0-300 PSI PRESSURE GAUGE..1/4 NPT MALE THREADS..MOUNTS CENTER BACK..1 EACH	\$ 10.85
MIL:1193	0-60 PSI PRESSURE GAUGE ..1/4 NPT MALE THREADS..MOUNTS BOTTOM ..1 EACH	\$ 10.85
MIL:1194	0-160 PSI PRESSURE GAUGE..1/4 NPT MALE THREADS..MOUNTS BOTTOM ..1 EACH	\$ 10.85
MIL:1195	0-300 PSI PRESSURE GAUGE..1/4 NPT MALE THREADS..MOUNTS BOTTOM ..1 EACH	\$ 10.85

Milton Precision Lubricators

Ideal for customers who want trouble free protection and tamper proof reliability. Drop style allows precise setting and then removal of adjustment knob. Perfect for lubricating air motors, tools, valves or where low air pressure is encountered or where extremely fine adjustments are necessary. Sight glass on drop type allows observation for instant drip rate adjustment. Tamper proof. Lubricator may be filled without shutting down line pressure. Oil supply tube check valve guarantees INSTANT START UP LUBRICATION. Low pressure drop at full air flow. Oil delivered at an air pressure as low as 2 SCFM. Safety bowl guard or metal bowl. All lubricators are drop type. Bowl capacity : 5oz. Maximum pressure : 150PSI. Temperature range : 40 to 125F. Polycarbonate bowls with metal bowl guards.

1028
1029
1030
1031-8



MIL:1028	1/4 NPT LUBRICATOR ..1 EACH	\$ 32.55
MIL:1029	3/8 NPT LUBRICATOR ..1 EACH	\$ 42.64
MIL:1030	1/2 NPT LUBRICATOR ..1 EACH	\$ 42.64
MIL:1031-8	1/2 NPT LUBRICATOR ..WITH METAL BOWL..1 EACH	\$ 55.99

Milton In-Line Lubricator

To lubricate pneumatic tools for full protection by accurately metering correct amount of oil. 1/2oz capacity.

MIL:S639	IN LINE LUBRICATOR 1/4 NPT FEMALE THREADS X 1/4 NPT MALE THREADS..1 EACH	\$ 2.68
----------	--	---------

Milton Piggyback Mini Filter/Regulator Duo

Ideal for use in compact air flow applications. Filter/regulator duo has same features as mini regulator plus the space saving convenience of a 20 micron screw in filter. Comes preassembled with 0-160PSI gauge. Height 6 1/4". Maximum SCFM : 20. Relieving type. Maximum pressure : 150PSI. Temperature range : 40 to 120F. Adjust 0 - 125PSI.

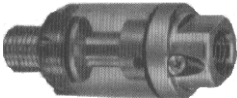

S639

MIL:S1142	PIGGYBACK MINI FILTER / REGULATOR DUO..1/4 NPT..1 EACH	\$ 24.41
-----------	--	----------

Other Brands

ALE:7936	1/4" MINI FILTER / REGULATOR..1 EACH	\$ 64.36
----------	--------------------------------------	----------

Milton Deluxe Filter/Regulator Duos

Factory assembled. Automatic overnight drain. Relieving regulator. Complete with #1191 gauge. 40 micron filter element. Outlet pressure range : 2 - 125PSI. Temperature range : 40 - 150F. Poly bowl with metal guard. Maximum pressure : 150PSI.

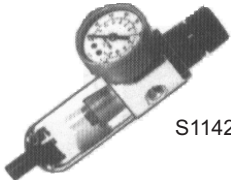

S1142

MIL:1107	FILTER / REGULATOR DUO..3/8 NPT..1 EACH	\$ 97.22
----------	---	----------

Metal guard. Maximum pressure : 250PSI.

MIL:1108	FILTER / REGULATOR DUO..1/2 NPT..1 EACH	\$ 110.67
----------	---	-----------

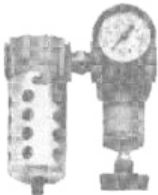

1107
1108

AIR HOSES AND FITTINGS

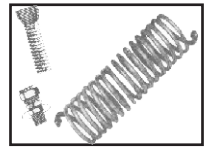

FILTERS, REGULATORS, AND LUBRICATORS

Milton Filter/Regulator/Lubricators Trios

All Milton Filter/Regulator/Lubricators have the following features : Automatic overnight drain. Relieving regulator. Drop style lubricator. Complete with #1191 gauge. 40 micron filter element. Outlet pressure range : 2 - 125PSI. Temperature range : 40 - 150F.

Poy bowl with metal guard. Maximum pressure : 150PSI.

M IL:1101	FILTER / REGULATOR / LUBRICATOR..3/8 NPT..1 EACH	\$ 142.68
-----------	--	-----------

Metal bowl. Maximum pressure : 250PSI.

M IL:1102	FILTER / REGULATOR / LUBRICATOR..1/2 NPT..1 EACH	\$ 168.18
-----------	--	-----------

Other Brands

N/S:1573	FILTER / REGULATOR / LUBRICATOR..1/4 NPT..1 EACH	\$ 113.70
----------	--	-----------

Milton Replacement Filter And Lubricator Bowls

Polycarbonate bowl kit for 1/4", 3/8" and 1/2" lubricators

M IL:1028-P	PLASTIC BOWL FOR 1028 LUBRICATOR..1 EACH	\$ 19.42
-------------	--	----------

Polycarbonate bowl kit for 1/2" lubricators

M IL:1120-P	PLASTIC BOWL FOR 1030 LUBRICATOR..1 EACH	\$ 28.48
-------------	--	----------

Milton Replacement Filter Element

Standard 40 micron filter element.

M IL:1118-1	40 MICRON REPLACEMENT FILTER ELEMENT..1 EACH	\$ 9.44
-------------	--	---------

Milton Mounting Bracket

M IL:1163	MOUNTING BRACKET FOR PIGGYBACKS AND REGULATORS..1 EACH	\$ 8.90
-----------	--	---------

Milton Compressor Tank Check Valves

Used in compressor tanks to prevent air volume from escaping back into compressor heads while the compressor is not operating. Brass body with teflon poppet. 1/8"NPT female side port for pressure switch application. 3/4" valve includes a built in dashpot for improved poppet life. Maximum working pressure : 450PSI.

3/4"NPT male tank bung hole. 3/4" male tube compression compressor air line size.

M IL:1091-2	COMPRESSOR TANK CHECK VALVE..1/2 NPT MALE THREADS..1 EACH	\$ 18.23
-------------	---	----------

1/2"NPT male tank bung hole. 1/2" female compressor air line size.

M IL:1092-1	COMPRESSOR TANK CHECK VALVE..1/2 NPT MALE & FEMALE THREADS..1 EACH	\$ 13.13
-------------	--	----------

Milton Pneumatic Exhaust Muffler

Muffler-filter uses porous sintered bronze, bonded to copper plated steel pipe threaded fitting. These 40 micron exhaust mufflers diffuse air and muffle noise from exhaust ports of air tools, cylinders and valves to an acceptable OSHA noise requirement. Size : 1/8"NPT. Length : 1 1/8". Hex : 7/16". Weight : .02lb.

M IL:1087-2	SUPER QUIET SILENCER/MUFFLER..1/8 NPT MALE THREADS..1 EACH	\$ 7.75
-------------	--	---------

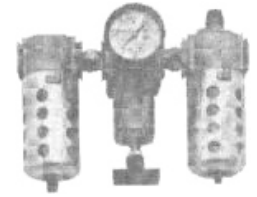

1101
1102

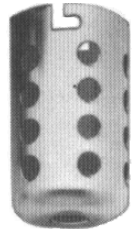

1028P

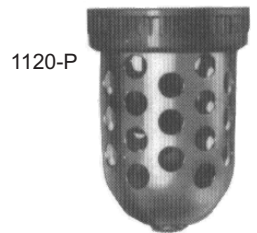

1120-P

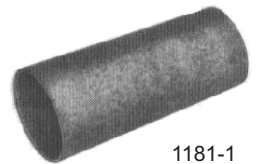

1181-1

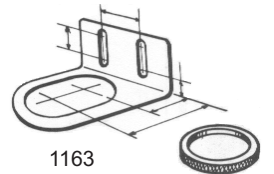

1163



1091-1

1092-2

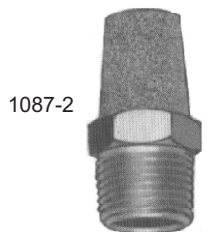

1087-2

PARKER, BROTHERS, INC.



FOR 50+ YEARS,
PARKER
BROTHERS
HAS BEEN
SERVING ATLANTA.
THANK YOU FOR
YOUR CONTINUED
SUPPORT!!

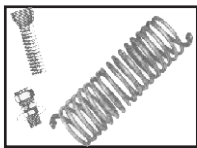

AIR HOSES AND FITTINGS

AIR COUPLER INTERCHANGE

1/4" Basic size: MILTON INDUSTRIAL "M" STYLE

MILTON	AMFLO	ARO	CAMEL	COIL HOSE	DIXON	FORNEY	LINCOLN	NAPA	PARKER	TRU-FLATE
711	C20-AU		61-572			75305	5878	90-669		13-201
715	C20	MSCF22-000	61-573	150	DC20	75317	632004	90-670	B23	13-235
716	C21	MSCM22-000	61-574	152	DC21	75316		90-672	B22	13-224
717	C20-42	MSCH22-000	61-575	153	DC2042	75480		90-671	B20-3B	13-264
717-6	C20-44	MSCH23-000	61-720		DC2044					123-266
718	C20-23	MSCF23-000	61-718	151	DC2023	75479		90-667	B23E	13-236
719	C21-03	MSCM23-000	61-716	155	DC2103			90-657	B22E	13.226
726	CP21-01	23902-110		1504	DC2101		630102	90-675	H0C	
727	CP21	23902-210	61-578	1501	DCP21	75301	630104	90-674	H2C	12-224/12-225
728	CP20	23902-200	61-579	1502	DCP20	75302	630204	90-676	H3C	12-234/12-235
729	CP20-21	23902-100		1509	DCP2021			90-665	H1C	
731	CP22		61-023							
732	CP20-23	23902-300		1505	DCP2023			90-659	H3C-E	12-236
733	CP21-03	23902-310	61-535	1503	DCP2103	75471		90-677	H2C-E	12-226
736	CP21-42	23902-220	61-576	1506	DCP2142			90-673	H8C	12-264
736-6	CP21-44	23902-420		1508	DCP2144	75472			H9C	12-266
745						75527				13-510/13-511
746						75526				13-508/13-509
755	C40B	MSCF22-X00	61-013		DCB20	75520		90-615	B33	13-755
756	C41B	MSCM22-X00	61-011		DCB21	75521		90-617	B32	13-756
1717-4	C20-42L	MSCP22-000							B20-3BP	
1717-6	C20-44L	MSCP23-000							B20-5BP	
1736-4	CP21-42L	23902-227							H8CP	
1736-6	CP21-44L	23902-228							H9CP	

1/4" Basic size: ARO 210 "A" STYLE

MILTON	AMFLO	ARO	CAMEL	COIL HOSE	DIXON	FORNEY	LINCOLN	NAPA	PARKER	TRU-FLATE
772						75522				13-301
775	C38, C46	210	61-518, 61-526	140	DC38	75318		90-613	B53	13-334/13-335
776	C37, C45	210-212	61-527, 61-581		DC37	75482			B50	13-324/13-325
776-4	C38-42	210-022			DC3842			90-679	B50-3BP	
776-6	C38-44	210-215			DC3844				B50-5BP	
777	CP37	2608	61-528	1401	DCP37	75303	13329	90-618	A2C	12-324/12-325
777-4	CP37-42	3946		1406	DCP3742				A8C	
777-6	CP37-44	22238			DCP3744					
778	CP38	2609	61-529	1402	DCP38	75473	13331	90-620	A3C	12-334/12-335
1776-4	C38-42L	210-227								
1776-6	C38-44L	210-028								
1777-4	CP37-42L	6944							A8CP	
1777-6	CP37-44L									

3/8" Basic size: ARO "AA" STYLE

MILTON	AMFLO	ARO	CAMEL	COIL HOSE	DIXON	FORNEY	LINCOLN	NAPA	PARKER	TRU-FLATE
1875	C36	310			DC36					
1877	CP35	3804			DCP35					
1878	CP36	3806			DCP36					

1/4" Basic size: LINCOLN "L" STYLE

MILTON	AMFLO	ARO	CAMEL	COIL HOSE	DIXON	FORNEY	LINCOLN	NAPA	PARKER	TRU-FLATE
790	C28	LNCF22-000	61-548	170	DC28	75523	815	90-644	B73	13-434/13-435
791	CP27	LNPM22-000	61-550	1701	DCP27	75304	11659	90-648	L2C	12-424/12-425
792	CP28	LNPF22-000	61-551	1702	DCP28	75524	11661	90-650	L3C	12-434/12-435
794	C27	LNCM22-000	61-486		DC27	75525		90-645		13-424/13-425

AIR HOSES AND FITTINGS

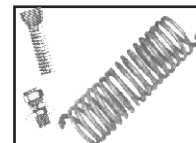

AIR COUPLER INTERCHANGE

1/4" Basic size: TRU-FLATE/PARKER "T" STYLE

MILTON	AMFLO	ARO	CAMEL	COIL HOSE	DIXON	FORNEY	LINCOLN	NAPA	PARKER	TRU-FLATE
779	CP12		61-544							12-104
780			61-543					90-634		
781	CP14		61-552					90-652		
782						75519		90-624		13-101
783	CP1	TFPM22-000	61-538	1601	DCP1	75300	5872	90-628	2C	12-124/12-125
783-4	CP1-42	TFPH22-000		1606	DCP142	75470		90-630	8C	12-117
783-6	CP1-44	TFPH23-000		1608	DCP143			90-626	9C	
784	CP2	TFPF22-000	61-539	1602	DCP2	75308	5873	90-600	3C	12-134/12-135
785	C2	TFCF22-000	61-523	160	DC2	75315	5871	90-610	B13	13-134/13-135
786	C1	TFCM22-000	61-524	162	DC1	75309	5870	90-607	B12	13-124/13-125
786-4	C2-42	TFCH22-000		163	DC242			90-611	B10-3B	13-164
786-6	C2-44	TFCH23-000		166	DC244			90-609	B10-5B	
787	C2R		61-487, 61-545			75478				13-136/13-137
788	C2-23	TFCF23-000	61-704							13-138
789	C1-03	TFCM23-000			DC103					
1783-4	CP1-42L	TFPP22-000							8CP	
1783-6	CP1-44L	TFPP23-000							9CP	
1786-4	C2-42L	TFCH22-000							B10-3BP	
1786-6	C2-44L	TFCH23-000							B10-5BP	

3/8" Basic size: MILTON INDUSTRIAL "H" STYLE

MILTON	AMFLO	ARO	CAMEL	COIL HOSE	DIXON	FORNEY	LINCOLN	NAPA	PARKER	TRU-FLATE
1796-6	C26-44L	MSCP33-000							24-5BP	
1797-6	CP25-44L	23903-28							H5EP	
1833	C26-22	MSCM32-000		582	DC2622			90-629	25C	
1834	C25-02							90-625		
1835	C26	MSCF33-000	61-482	580	DC26	75321	642006	90-680	25	13-536/13-537
1836	C25	MSCM33-000	61-483	581	DC25	75483		90-682	24	13-526/13-527
1836-6	C26-44	MSCH33-000		586	DC2644			90-635	24-6B	
1837	CP25	23903-310	61-484	5801	DCP25	75307	640108	90-683	H2E	12-526/12-527
1837-6	CP25-44	23903-420		5806	DCP2544			90-651	H5E	
1838	CP26	23903-300	61.485	5802	DCP26	75474	640206	90-681	H3E	12-536/12-537
1839	CP25-02	23903-210		5803	DCP2502		640104	90-605	H0E	12-525
1840	CP26-22	23903-200		5804	DCP2622		640204	90-606	H1E	12-535

3/8" Basic size: TRU-FLATE/PARKER "P" STYLE

MILTON	AMFLO	ARO	CAMEL	COIL HOSE	DIXON	FORNEY	LINCOLN	NAPA	PARKER	TRU-FLATE
1746-6	C6-44L	TFCP23-000							14-5BP	
1747-6	CP5-44L	TFPP23-000							5EP	
1803	C8	TFCF32-000	61-476	592	DC8	75485		90-686	15C	13-610/13-611
1804	C7	TFCM32-000	61-478		DC7			90-684		13-602
1805	C6	TFCF33-000	61-553	590	DC6	75320	5874	90-654	15	13-612/13-613
1806	C5	TFCM33-000	61-554	591	DC5	75484		90-656	14	13-604
1806-6	C6-44	TFCH33-000		598	DC644			90-521	14-5B	13-666
1807	CP5	TFPM33-000	61-558	5901	DCP5		5875	90-658	2E	12-604/12-605
1807-6	CP5-44	TFPH33-000		5906	DCP544			90-530	5E	
1808	CP6	TFPF33-000	61-559	5902	DCP6	75476	5876	90-660	3E	12-612
1809	CP7	TFPM32-000	61-480	5903	DCP7	75475		90-685	0E	12-602/12-603
1810	CP8	TFPF32-000	61-481	5904	DCP8			90-687	1E	12-610

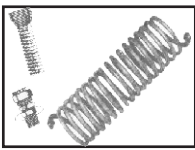

AIR HOSES AND FITTINGS

AIR COUPLER INTERCHANGE

1/2" Basic size: MILTON INDUSTRIAL "G" STYLE

MILTON	AMFLO	ARO	CAMEL	COIL HOSE	DIXON	FORNEY	LINCOLN	NAPA	PARKER	TRU-FLATE
1813	C10-23	TFCF43-000	61-472	123	DC1023			90-690	17E	13-710
1814	C9-03	TFCM43-000		121	DC903			90-688	16E	13-702
1815	C10	TFCF44-000	61-563	120	DC10		652008	90-662	B37	13-712/13-713
1816	C9	TFCM44-000	61-564	122	DC9			90-664	B36	13-704
1855										
1857	CP17	23904-410	61-134	1201	DCP17		650108	90-578	H2F	12-752
1858	CP18	23904-400	61-137	1202	DCP18		650208	90-588	H3F	12-762
1859	CP17-03	23904-310	61-133	1203	DCP1703		650106	90-575	H0F	
1860	CP18-23	23904-3	61-136	1204	DCP1823		650206	90-587	H1F	

1/2" Basic size: TRU-FLATE/PARKER "G" STYLE

MILTON	AMFLO	ARO	CAMEL	COIL HOSE	DIXON	FORNEY	LINCOLN	NAPA	PARKER	TRU-FLATE
1813	C10-23	TFCF43-000	61-472	123	DC1023			90-690	17E	13-710
1814	C9-03	TFCM43-000		121	DC903			90-688	16E	13-702
1815	C10	TFCF44-000	61-563	120	DC10		652008	90-662	B37	13-712/13-713
1816	C9	TFCM44-000	61-564	122	DC9			90-664	B36	13-704
1817	CP9	TFPM44-000	61-568		DCP9			90-666	2F	12-704/12-705
1818	CP10	TFPF44-000	61-569		DCP10			90-668	3F	12-712
1819	CP9-03	TFPM43-000	61-474		DCP903			90-689	0F	12-702
1820	CP10-23	TFPF43-000	61-475		DCP1023			90-691	1F	12-710

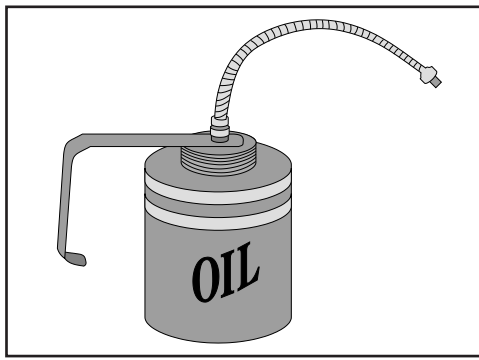

FLUID MANAGEMENT

CHEMICAL PUMPS
FUEL PUMPS
MANUAL OIL PUMPS
AIR OPERATED OIL PUMPS, ETC.
ELECTRIC OIL PUMP
GREASE GUNS
MANUAL GREASE PUMPS
AIR OPERATED GREASE PUMPS
GREASE DELIVERY ACCESSORIES
DRAIN PANS
OIL CANS
FUNNELS
FUEL STORAGE
FUEL NOZZLES
HOSE ASSEMBLIES
ACCESSORIES

PARKER BROTHERS, INC.

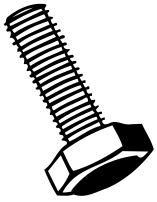

Mystik
The Ultimate
In Fine
Lubrication

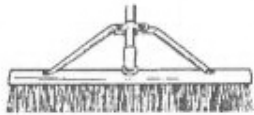
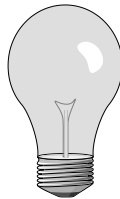
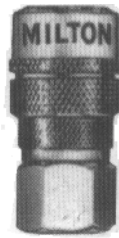

NATIONAL-SPENCER, INC.



Permatex



FLUID MANAGEMENT



CHEMICAL PUMPS

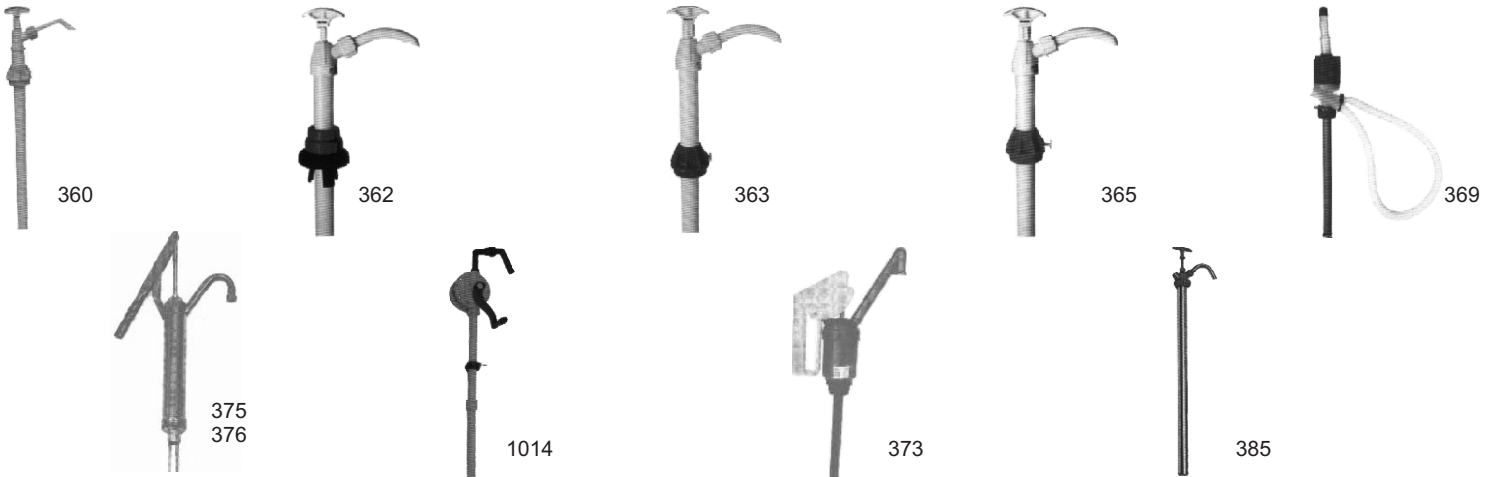

National-Spencer Chemical Pumps

Constructed of polypropylene with a nickle plated steel rod and Viton seals, These pumps can be used with mild acids, antifreeze, detergents and windshield washer solvents. Complete with bung adapter.

N/S:360	15-55 GAL CONTAINER LIFT STYLE CHEMICAL PUMP..1 EACH	\$ 36.14
N/S:360-CN	REPLACEMENT COUPLING NUT..1 EACH	\$ 1.39
N/S:360-SPT	REPLACEMENT SPOUT..1 EACH	\$ 1.56

Constructed of nylon with a nickle plated steel rod and Viton seals, These pumps can be used with mild acids, antifreeze, detergents and windshield washer solvents. Complete with bung adapter.

N/S:363	15-55 GAL CONTAINER LIFT STYLE CHEMICAL PUMP..1 EACH	\$ 43.32
---------	--	----------

Constructed of nylon with a stainless steel rod and teflon seals, These pumps can be used with mild acids, antifreeze, detergents, MEK, acetone, lacquer thinner and windshield washer solvents. Complete with bung adapter.

N/S:365	15-55 GAL CONTAINER LIFT STYLE CHEMICAL PUMP..1 EACH	\$ 50.77
---------	--	----------

These siphon pumps siphon lower and pump higher. 1" inlet and outlet. These pumps can be used with mild acids, antifreeze, detergents, MEK, acetone, lacquer thinner, gasoline and windshield washer solvents. Complete with bung adapter.

N/S:369	55 GAL CONTAINER SIPHON CHEMICAL PUMP..1 EACH	\$ 28.00
---------	---	----------

This yellow, light weight, corrosion resistant lever style pump is designed to pump water based fluids, acids, and alkali solutions. It is constructed of polypropylen, has viton and polypropylene seals, and a stainless steel rod. It comes with a telescoping suction tube and an adjustable bung adapter which fits 1.25" or 2" openings. 12oz. per stroke

N/S:375	15-55 GAL CONTAINER LEVER STYLE CHEMICAL PUMP..1 EACH	\$ 46.15
---------	---	----------

This black, light weight, corrosion resistant lever style pump is designed to pump stronger acids, alkali solutions, and Nitric acid. It is constructed of Ryton, has viton and polypropylene seals, and a stainless steel rod. It comes with a telescoping suction tube and an adjustable bung adapter which fits 1.25" or 2" openings. 12oz. per stroke

N/S:376	15-55 GAL CONTAINER LEVER STYLE CHEMICAL PUMP..1 EACH	\$ 64.61
---------	---	----------

Rotary pump. Lightweight and corrosion resistant. Constructed of polypropylene with teflon seals. Dispenses 8oz. per revolution. These pumps can be used with antifreeze, light oils (up to 30wt.), Methanol, chlorinated solvents and windshield washer solvents. Complete with bung adapter. Applications : agricultural, automotive, and industrial

N/S:1014	15-55 GAL CONTAINER PLASTIC ROTARY HAND PUMP..1 EACH	\$ 81.86
----------	--	----------

Plastic lever style pump for oil and water based products. Constructed of glass filled nylon and Viton seals, Complete with 2" bung adapter and locking nut. Delivers 1 pint per strokes. 3/4" hose barb outlet spout. .

N/S:373	5-55 GAL CONTAINER LEVER STYLE CHEMICAL PUMP..1 EACH	\$ 80.78
---------	--	----------

Steel lift pump for mils acids, antifreeze, detergents, and other mild chemicals. Constructed of stainless/ polyethylenel with a stainless steel piston rod and Viton seals, Complete with 2" bung adapter Delivers 22oz. per strokes.

N/S:385	55 GAL CONTAINER LIFT STYLE CHEMICAL PUMP..1 EACH	\$ 39.64
---------	---	----------

def def def def def .

N/S:10211	DEF PUM ...1 EACH	\$ 86.23
-----------	-------------------	----------

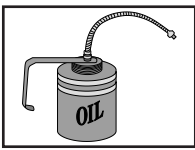

FLUID MANAGEMENT

CHEMICAL PUMPS

Hand operated tire sealant pump. Includes : 5ft. vinyl hose, powder coated cover, quick connect valve stem coupler and return valve. Adjustable collar to preset amount dispensed. Maximum 8oz. pre stroke. For pumping tire sealant directly into tubeless tires.

N/S:240	TIRE SEALANT PUMP ..1 EACH	\$ 67.09
---------	----------------------------	----------

Other Brands

W/W:56222	PUMP FOR 5 GAL TIRE SEALER..1 EACH	\$ 83.04
-----------	------------------------------------	----------

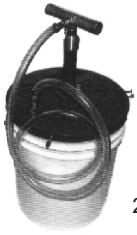

240

FUEL PUMPS



926



928

National-Spencer Electric Fuel Pumps

12 volt DC electric vane pump. 20 amp draw. Features include : 13 GPM flow rate, cast iron construction, 1"NPT inlet, 3/4"NPT outlet, 15'. Power cord (12volt only), 3/4" x 10' hose with static wire, 1/4hp explosion proof motor, manual nozzle holster with lock and positive displacement. Duty cycle : 30 minutes on, 30 minutes off. Fits 15-55 gallon drums. Recommended for gasoline, diesel fuel, kerosene, and mineral spirits. Applications : automotive, agricultural and industrial. UL approved.

N/S:926	12 VOLT VANE FUEL PUMP ..1 EACH	\$ 557.70
---------	---------------------------------	-----------

Electric gear pump. 12 volt fuel pump with overload protected motor. Designed for mounting on portable, vented tanks. Pump housing is lightweight, corrosion resistant cast aluminum. Flow rate : 15 GPM. Duty cycle : 30 minutes on, 30 minutes off. Suction lift : 5.5' minimum for manual. Discharge lift : 19.5' manual. Total lift : 25' manual. Temperature range : -20 to 125F. Input : 12 volt DC. Conduit : 1/2" FNPT. Cord : 15' , 12 gauge. Current draw : 18 amp for manual nozzle. Motor : 1900 RPM permanent magnet. Motor protection : 20 amp. 2"NPT bung. 1"NPT inlet. 3/4"NPT outlet. 3/4" x 12" Buna-N statically grounded hose. NPT manual shutoff, lockable unleaded nozzle. Plastic, adjustable (22" to 40") suction pipe. Convenient spin collar for easy installation. UL listed. CSA certified.

N/S:928	12 VOLT GEAR FUEL PUMP ..1 EACH	\$ 587.73
---------	---------------------------------	-----------



1007

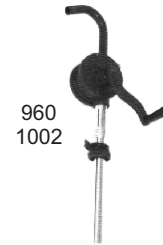

960
1002

National-Spencer Manual Fuel Pumps

Heavy duty multi-directional rotary vane hand fuel pump. Features include : cast iron construction, bi-directional, self adjusting vanes, smooth operation, 2" bung adapter, 3/4"NPT male discharge spout. Fits 15-55 gallon drum. Dispenses 12oz. per revolution. Recommended for pumping gasoline, diesel fuel and oil directly from a 55 gallon drum. Applications : automotive, agricultural, and industrial.

N/S:1007	15-55 GAL CONTAINER MULTI-DIRECTIONAL ROTARY HAND PUMP ..1 EACH	\$ 215.75
----------	---	-----------

Rotary pumps. Features include : cast iron construction, smooth operation, 2" bung adapter, 3/4"NPT male discharge spout and 1 piece rigid suction tube. Fits 15-55 gallon drum. Dispenses 8oz. per revolution. Recommended for : gasoline, diesel fuel and light oil. #1003 includes 8' hose and manual nozzle.

N/S:1002	15-55 GAL CONTAINER ROTARY HAND PUMP ..1 EACH	\$ 67.27
----------	---	----------

N/S:1003	15-55 GAL CONTAINER ROTARY HAND PUMP WITH HOSE & NOZZLE..1 EACH	\$ 91.48
----------	---	----------

Rotary pumps. Features include : cast iron construction, 2 heavy duty cast iron vanes, Hi Nitrile rubber seals, rubber water deflector for suction tube, bi-directional flow, 2" bung adapter, 3/4"NPT male discharge spout and 3 piece rigid suction tube. Fits 15-55 gallon drum. Dispenses 8oz. per revolution. Recommended for : gasoline, diesel fuel and light oil.

N/S:960	15-55 GAL CONTAINER ROTARY FUEL PUMP ..1 EACH	\$ 56.78
---------	---	----------

FLUID MANAGEMENT



FUEL PUMPS

Premium quality hand diaphragm pump. Made in the U.S.A.! Features include :2" bung adapter, 22" to 39" telescoping suction tube, 8' hose and lockable handle. Dispenses 1 gallon per 8 strokes. Fits 15-55gallon drum. Recommended for gasoline and diesel fuel.

N/S:30A-1	15-55 GAL CONTAINER FUEL PUMP WITH 8' HOSE..1 EACH	\$ 156.63
-----------	--	-----------

Fuel transfer hand operated pump for transferring fuel from one container to another. Features include : carbon steel construction, double check valve, Viton o-rings and 2 4' clear vinyl hoses. Barrel size : 2 1/4" x 11". Dispenses 14oz. per stroke.

N/S:103	FUEL TRANSFER PUMP WITH 2 - 4' VINYL HOSES..1 EACH	\$ 34.68
---------	--	----------

MANUAL OIL PUMPS

National-Spencer Manual Oil Pumps

Quart stroke hand pump. Features include ; 2" bung adapter, swing return drain tube, lockable crank arm and Delrin seals. Delivers 1 quart per stroke. Fits 15-55 gallon drums.

N/S:975	15-55 GAL CONTAINER QT STROKE OIL PUMP..1 EACH	\$ 187.65
---------	--	-----------

Double action hand pump. Includes drum cover, dolly, and 5' delivery hose. Features include : even and constant double action, adjusting lever for varying oil viscosity, telescoping suction tube, pump locking ring, Buna-N seals and plated carbon steel construction. Delivers 4oz. per stroke. Fits 16 gallon drum. Recommended for oils with viscosities of 5 to 130 weight. Applications where portable, manual oil transfer is desired. #1208 includes pint meter.

N/S:1208	120 LB CONTAINER OIL PUMP WITH METER..1 EACH	\$ 550.27
----------	--	-----------

N/S:1209	120 LB CONTAINER OIL PUMP..1 EACH	\$ 245.57
----------	-----------------------------------	-----------

Lift pump. Features include : #366 Buna-N seals, #366T Teflon seals, plated steel construction with die cast aluminum head, heavy duty bar stock handle, cast iron bung adapter for long lasting threads, 1/2" garden hose threaded spout allows for threaded connection or slip type connection and brass piston rings pump many type products without deterioration. Delivers 1.5 pints per complete lift. Length : 37.5". Fits 15-55 gallon drums. Recommended for light oils (maximum 40 wt.), Kerosene, ATF, hydraulic fluid, paint thinners and non-corrosiive chemicals (366T only). Applications shop use for dispensing from drums into small measurers or open containers.

N/S:366	15-55 GAL CONTAINER LIFT STYLE OIL PUMP..1 EACH	\$ 30.46
---------	---	----------

N/S:366T	15-55 GAL CONTAINER LIFT STYLE OIL PUMP..1 EACH	\$ 30.46
----------	---	----------

Lever style pump. For dispensing oils and gear lubes from 55 gallon drums. Features include : 5' vinyl hose, curved nozzle, zinc plated body with die cast aluminum head, 2" bung adapter and plated carbon steel tube and handle. 3 position pivot allows for delivery of up to 2.65oz. per stroke.

N/S:155	30-55 GAL CONTAINER LEVER STYLE OIL PUMP WITH 5' HOSE..1 EACH	\$ 42.13
---------	---	----------

Lever style gear lube pump. For dispensing oil and gear lube (maximum 140wt.) from 16 gallon drums. Comes with 5' vinyl hose and Buna-N seals. Delivers 3oz. per stroke.

N/S:336	16 GAL LEVER STYLE OIL PUMP WITH 5' HOSE..1 EACH	\$ 66.18
---------	--	----------

Lever style pump. For dispensing oil and gear lube (maximum 140wt.) from 15-55 gallon drums. 2" bung adapter. Garden hose threaded nozzle. Delivers 2oz. per stroke.

N/S:338	15-55 GAL LEVER STYLE OIL PUMP..1 EACH	\$ 33.04
---------	--	----------

Variable stroke pump. Features include : heavy duty rubber grip pump lever, brass piston rings for long wear and resistance to oil additives Buna-N seals, powder coated silver gray steel construction with a die cast aluminum head and telescoping suction tube. Taller than most pumps (15" from drum to spout). Variable stroke allows for transfer different viscosity fluids. Delivers 9.5oz. to 15oz. per stroke. Fits 15-55 gallon drums. Recommended for light weight oils (maximum 40wt.), hydraulic oil, ATF, kerosene and diesel fuel.

N/S:382	15-55 GAL CONTAINER LEVER STYLE OIL PUMP..1 EACH	\$ 39.64
---------	--	----------

Lever style pump. Features include : non-drip attachment, rugged steel construction, red powder coat finish, Buna-N seals, garden hose threaded spout and telescoping suction tube. Fits 15-55 gallon drum. Delivers 1 pint per stroke. Ideal for jobs where a heftier pump is required.

N/S:D-S	15-55 GAL CONTAINER LEVER STYLE OIL PUMP..1 EACH	\$ 35.79
---------	--	----------

Suction gun for transferring light oil, hydraulic oil and ATF. Holds 17oz. Comes with 12" clear vinyl hose. Applications : automotive, agricultural and industrial.

N/S:101	1PT SUCTION GUN WITH 12" VINYL HOSE..1 EACH	\$ 13.05
---------	---	----------

Gear Lube hand pump. For dispensing gear lube (maximum 140 wt.). Features include : variable stroke handle, powder coated cover, 4" vinyl hose, Buna-N seals and curved nozzle. Fits 5-6.5 gallon pails. Delivers 1 to 2.3oz. per stroke. Recommended for oil and gear lube.

N/S:321	5 GAL CONTAINER OIL PUMP WITH 4' HOSE..1 EACH	\$ 36.98
---------	---	----------

Other Brands

ALE:6796	55 GAL DRUM LEVER PUMP..1 EACH	\$ 50.85
----------	--------------------------------	----------

ALE:H401	16 - 55 GAL DRUM ROTARY PUMP..1 EACH	\$ 68.35
----------	--------------------------------------	----------

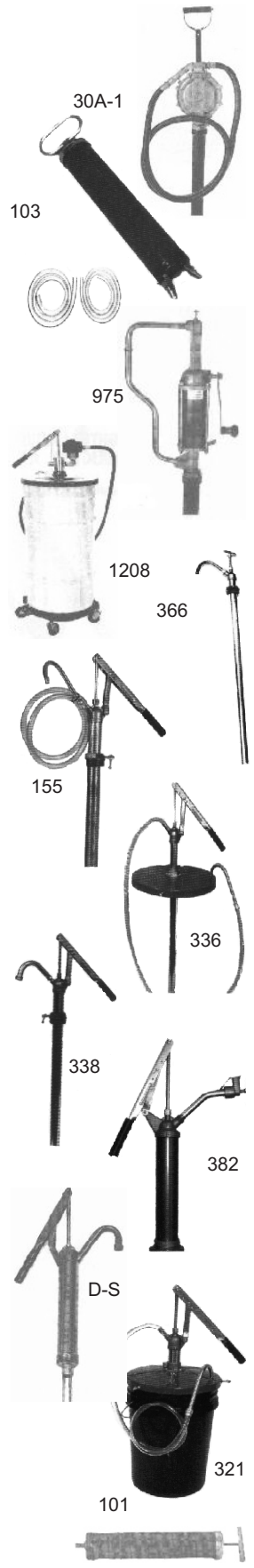

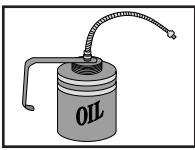

FLUID MANAGEMENT

AIR OPERATED OIL PUMPS, ETC

National-Spencer

Save money by buying a complete equipment package!! This package includes : 3:1 stubby style pump (1712) 32' hose on a reel (1475R), mechanical control handle (1515), air filter with auto water drain, regulator, gauge, ball valve, quick disscnects and all connecting components.

N/S:6116	AIR OPERATED OIL PUMP WITH REEL & CONTROL HANDLE..1 EACH	\$ 1450.62
----------	--	------------

National-Spencer Air Operated Oil Pumps

3:1 ratio stub style single action pneumatic pump. For dispensing fluids from varies size containers by adjusting the length of the suction tube. Suction tube thread size : 1"NPT. Feature include : foot valve with screen, air filter with auto water drain, 1/2" x 48" oil hose, 1/4" x 48" air connection hose, male and female quick air couplers, needle valve and bung adapter. Delivery rate : 3.7 GPM. Recommended for oil (maximum 130 wt.) and antifreeze.

N/S:1700X	AIR OPERATED STUB STYLE OIL PUMP ..1 EACH	\$ 610.46
-----------	---	-----------

3:1 ratio single action pneumatic pump. For dispensing medium to high viscosity fluids from both fixed and mobile installations. Suction tube : length 37", diameter 1.5". Fits 55 gallon drums. Feature include : foot valve with screen, air filter with auto water drain, 1/2" x 48" oil hose, 1/4" x 48" air connection hose, male and female quick air couplers, needle valve and bung adapter. Delivery rate : 3.7 GPM. Recommended for oil based fluids and antifreeze.

N/S:1702X	AIR OPERATED 55 GAL CONTAINER OIL PUMP..1 EACH	\$ 559.02
-----------	--	-----------

1:1 ratio double diaphragm pump. Feature include : polypropylene construction, Buna N check valve, 1/2" NPT inlet/outlet, non-stalling / lube free operation, (2) 1/2" x 4' oil hoses, air filter with auto water drain, regulator, gauge, ball valve, quick disscnects.

N/S:1037	AIR OPERATED DOUBLE DIAPHRAGM OIL PUMP..1 EACH	\$ 620.72
----------	--	-----------

Other Brands

ALE:9918A	AIR OPERATED 55 GAL CONTAINER OIL PUMP..1 EACH	\$ 714.00
-----------	--	-----------

National-Spencer Control Handles

Digital metered control handle. For dispensing and totalizing in quarts. Recommended for motor oil, ATF, hydraulic fluid and gear oil. Features include : extension hose with automatic nozzle and non-drip attachment (#1315A). Rubber shroud (#629) and control handle (#1572R). Specifications : maximum flow rate - 8 GPM, minimum flow rate - 0.25 GPM, maximum operating pressure - 1500 PSI, maximum operating temperature - 110F. Accuracy viscosity >40cps - +/- .05%, accuracy viscosity <40cps - =-4.0%, weight 1.5lb.

N/S:1504	DIGITAL TOTALIZING QT CONTROL HANDLE..1 EACH	\$ 264.44
----------	--	-----------

Mechanical preset metered control handle. For dispensing and totalizing in quarts. Preset 1 to 16 quarts in 1/4 quart increments. Recommended for motor oil ,ATF, hydraulic fluids and gear oil. Features include : easy grip handle, large easy to read dial, 1/2" pipe with automatic nozzle (#1340) and 1/2"NPT threads on inlet and outlet. Specifications : maximum flow rate - 4 GPM, minimum flow rate - 0.4 GPM, maximum operating pressure - 1000PSI, maximum operating temperature - 150F., accuracy - +/-0.65%, weight 3.3lb.

N/S:1519	QT PRESET & TOTALIZING CONTROL HANDLE..1 EACH	\$ 563.88
----------	---	-----------

Mechanical preset metered control handle. For dispensing and totalizing in gallons. Preset 1 to 60 quarts in 1 quart increments. Recommended for motor oil ,ATF, hydraulic fluids and gear oil. Features include : easy grip handle, large easy to read dial, 1/2" pipe with automatic nozzle (#1340) and 1/2"NPT threads on inlet and outlet. Specifications : maximum flow rate - 4 GPM, minimum flow rate - 0.4 GPM, maximum operating pressure - 1000PSI, maximum operating temperature - 150F., accuracy - +/-0.65%, weight 3.3lb.

N/S:1520	QT PRESET GAL TOTALIZING CONTROL HANDLE..1 EACH	\$ 563.88
----------	---	-----------

Mechanical metered control handle. For dispensing and totalizing in pints.1/4 pint increments. Totals 8 pints. Recommended for motor oil ,ATF, hydraulic fluids and gear oil. Features include : 3.5" easy to read dial, swivel adapter and 1/2"NPT threads on inlet and outlet. Specifications : maximum flow rate - 4 GPM, minimum flow rate - 0.4 GPM, maximum operating pressure - 1000PSI, maximum operating temperature - 150F., accuracy - +/-0.65%, weight 3.3lb.

N/S:1503	TOTALIZING PT CONTROL HANDLE..1 EACH	\$ 491.12
----------	--------------------------------------	-----------

Mechanical metered control handle. For dispensing and totalizing in quarts.1/4 quart increments. Totals 16 quarts. Recommended for motor oil ,ATF, hydraulic fluids and gear oil. Features include :14" hose with manual nozzle (#1315), 3.5" easy to read dial, swivel adapter and 1/2"NPT threads on inlet and outlet. Specifications : maximum flow rate - 4 GPM, minimum flow rate - 0.4 GPM, maximum operating pressure - 1000PSI, maximum operating temperature - 150F., accuracy - +/-0.65%, weight 3.3lb.

N/S:1515	TOTALIZING QT CONTROL HANDLE..1 EACH	\$ 367.57
----------	--------------------------------------	-----------

Basic control handle. Recommended for motor oil ,ATF, hydraulic fluids and gear oil. Features include : rigid pipe outlet and swivel adapter.

N/S:1572R	CONTROL HANDLE WITH SWIVEL..1 EACH	\$ 48.66
-----------	------------------------------------	----------

Basic control handle. Recommended for motor oil ,ATF, hydraulic fluids and gear oil. Features include :14" hose with manual nozzle (#1315), manual non drip tip (#26) and a swivel adapter.

N/S:1575	CONTROL HANDLE WITH SWIVEL & WHIP HOSE..1 EACH	\$ 83.06
----------	--	----------

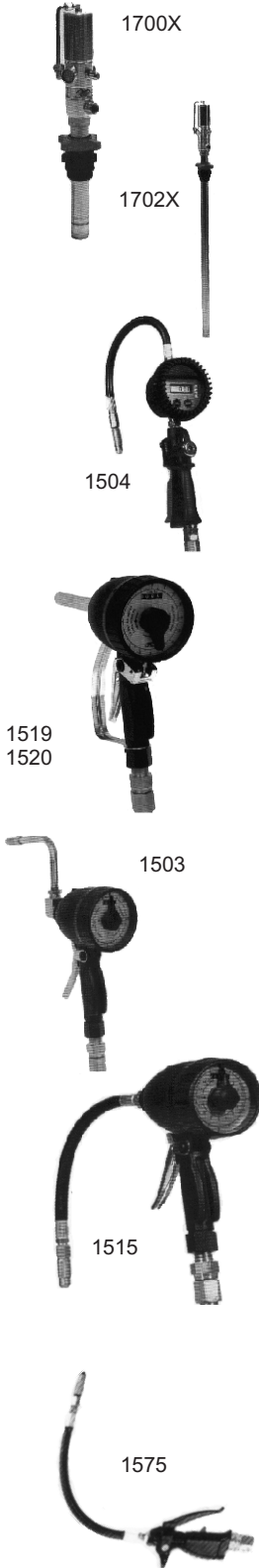

FLUID MANAGEMENT

AIR OPERATED OIL PUMPS, ETC

Basic control handle. Recommended for motor oil ,ATF, hydraulic fluids and gear oil. Features include :14" hose with manual nozzle (#1315) and manual non drip tip (#26).

N/S:1587	CONTROL HANDLE WITH WHIP HOSE..1 EACH	\$ 94.56
----------	---------------------------------------	----------

Other Brands

ALE:7492	NON-METERED CONTROL HANDLE..1 EACH	\$ 152.13
ALE:7498	NON-METERED NO-DRIP CONTROL VALVE..1 EACH	\$ 133.71

National-Spencer In-Line Meters

In line meters. For dispensing in pints. Non totalizing. ¼ pint increments. Dail totals 8 pints. Recommended for motor oil, ATF, hydraulic oil and gear oil. Features include : 3.5" easy to read dial, 1/2"NPT threaded inlet and outlet, outlet port rotate 90 degrees. Specifications : maximum flow rate - 4 GPM, minimum flow rate - 4 GPM, maximum operating pressure - 1000PSI, maximum operating temperature - 150F., accuracy - +/-0.65%, weight 3.3lb.

N/S:1500	IN LINE PT METER..1 EACH	\$ 286.00
----------	--------------------------	-----------

In line meters. For dispensing and totalizing in quarts. ¼ quart increments. Dail totals 16 quarts. Recommended for motor oil, ATF, hydraulic oil and gear oil. Features include : 3.5" easy to read dial, 1/2"NPT threaded inlet and outlet, outlet port rotate 90 degrees. Specifications : maximum flow rate - 4 GPM, minimum flow rate - 4 GPM, maximum operating pressure - 1000PSI, maximum operating temperature - 150F., accuracy - +/-0.65%, weight 3.3lb.

N/S:1505	IN LINE QT METER..1 EACH	\$ 310.75
----------	--------------------------	-----------

National-Spencer Control Handle Accessories

Hose. Length : 14". Diameter : 1/2". Threaded : 1/2" x 1/4" NPT. Complete with manual non drip nozzle (#26).

N/S:1315	14" CONTROL HANDLE FLEXIBLE HOSE WITH NON DRIP NOZZLE..1 EACH	\$ 25.67
----------	---	----------

Rigid nozzle. Straight 6" pipe. Threaded : 1/2"NPT. Complete with automatic non drip nozzle (#26A).

N/S:1340	6" CONTROL HANDLE PIPE WITH NON DRIP NOZZLE..1 EACH	\$ 12.70
----------	---	----------

Manual non drip nozzle. Threaded : 1/4"NPT female. For use with models : 1315 and 1340.

N/S:26	MANUAL NON DRIP TIP..1 EACH	\$ 8.92
--------	-----------------------------	---------

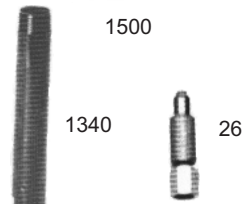
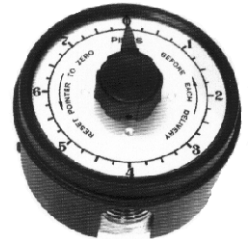
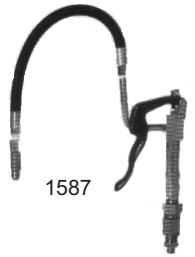

ELECTRIC OIL PUMPS

National-Spencer Electric Oil Pumps

Features include : 1" NPT inlet port, 3/4" NPT outlet port, 3/4" x 8' hose, 2 piece plastic 35" suction tube, easy access screen for simple maintenance, built in bypass valve and on/off switch, self priming, positive displacement, 1/3 hp weather resistant motor, and 2" NPT quick detach coupler. Maximum outlet pressure - 50 PSI. 115 volt AC. 4 GPM.

N/S:936R	ELECTRIC OIL PUMP..1 EACH	\$ 604.28
----------	---------------------------	-----------

Features include : 1" NPT inlet port, 3/4" NPT outlet port, easy access screen for simple maintenance, built in bypass valve and on/off switch, self priming, positive displacement, 1/3 hp weather resistant motor, and 2" NPT quick detach coupler. Maximum outlet pressure - 50 PSI. 115 volt AC. 2.5 GPM.

N/S:937R	ELECTRIC OIL PUMP..1 EACH	\$ 923.99
----------	---------------------------	-----------

Features include : 1" NPT inlet port, 3/4" NPT outlet port, 3/4" x 8' hose, 2 piece plastic 35" suction tube, easy access screen for simple maintenance, built in bypass valve and on/off switch, self priming, positive displacement, 1/3 hp weather resistant motor, and 2" NPT quick detach coupler. Maximum outlet pressure - 50 PSI. 115 volt AC. 8 GPM.

N/S:938R	ELECTRIC OIL PUMP..1 EACH	\$ 623.40
----------	---------------------------	-----------

GREASE GUNS

Alemite Hand Held Grease Guns

This heavy duty grease gun develops 10,000PSI per stroke. It features air vent fitting, vinyl grip, deluxe pull handle, and three way loading. (Loader nip included)

ALE:500	LEVER GREASE GUN..1 EACH	\$ 33.32
---------	--------------------------	----------

These heavy duty grease guns develops 4,500 PSI per stroke. They features air vent fitting, vinyl grip, deluxe pull handle, and three way loading. (Loader nip included)

ALE:555	PISTOL GRIP GREASE GUN..1 EACH	\$ 45.05
---------	--------------------------------	----------

ALE:555-E	PISTOL GRIP GREASE GUN WITH WHIP HOSE..1 EACH	\$ 48.60
-----------	---	----------

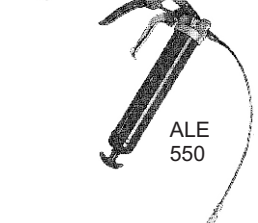
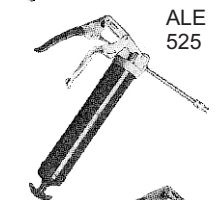
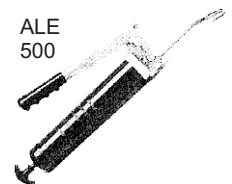

FOR 50+ YEARS,
PARKER
BROTHERS
HAS BEEN
SERVING ATLANTA.
**THANK YOU FOR
YOUR CONTINUED
SUPPORT!!**

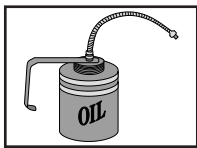

FLUID MANAGEMENT

GREASE GUNS

National-Spencer 12 Volt Grease Gun

These battery operated grease guns have an 8000 PSI rating. They come with 2 Nicad batteries, 30" whip hose, battery charger, air bleeder valve, and a hard plastic case. They hold 14 oz. cartridges, have 1/8" NPT threads, and multiple loading options. Recommended for NLGI #2 greases.

N/S:912	14 OZ TUBE 12 VOLT CORDLESS GREASE GUN..1 EACH	\$ 179.45
---------	--	-----------

National-Spencer Hand Held Grease Guns

Pistol grip grease gun. Zinc plated with rigid pipe. Maximum pressure : 5000PSI. Holds 14.5oz. cartridge. 1/8"NPT threads. Loader nipple optional. Loading via cartridge, suction or bulk. Comfortable one hand operation. Air release achieved through half turn of head assembly. Delivers 1oz. per 40 strokes. Recommended for greases through NLGI #2.

N/S:610	PISTOL STYLE GREASE GUN..1 EACH	\$ 22.73
---------	---------------------------------	----------

Lever style grease gun. Powder coated finish. Chrome plated. Rigid pipe included. Maximum pressure : 7000PSI. Holds 14.5 oz. cartridge. 1/8"NPT threads. Loading via cartridge, suction or bulk. Delivers 1oz. per 28 strokes. Recommended for greases through NLGI #2.

N/S:444	POWDER COATED LEVER GREASE GUN..1 EACH	\$ 20.07
---------	--	----------

Lever style grease gun. Zinc plated. Rigid pipe included. Maximum pressure : 7000PSI. Holds 14.5 oz. cartridge. 1/8"NPT threads. Loading via cartridge, suction or bulk. Air release achieved through half turn of head assembly. Delivers 1oz. per 28 strokes.

N/S:410	ZINC PLATED LEVER STYLE GREASE GUN..1 EACH	\$ 19.68
---------	--	----------

Variable stroke lever style grease gun. Premium series with cast iron head. Powder coated finish. #HD4 comes with a rigid pipe. #HD4A comes with a 12" whip hose. Maximum pressure : 10000PSI. Holds 14.5 oz. cartridge. 1/8"NPT threads. Loading via cartridge, suction or bulk. Delivers 1oz. per 28 strokes. Loader nipple included (P/N 80). Short stroke for ease of use in confined spaces. Heavy duty head incorporates a bulk loader. Recommended for greases through NLGI #2.

N/S:HD4	HEAVY DUTY LEVER STYLE GREASE GUN..1 EACH	\$ 26.34
---------	---	----------

N/S:HD4A	HEAVY DUTY LEVER STYLE GREASE GUN WITH 12" WHIP HOSE..1 EACH	\$ 30.20
----------	--	----------

Other Brands

ALE:F101	ECONOMY LEVER GREASE GUN..1 EACH	\$ 18.28
----------	----------------------------------	----------

ALE:F106	ECONOMY LEVER GREASE GUN..1 EACH	\$ 8.81
----------	----------------------------------	---------

MANUAL GREASE PUMPS

National Spencer Manual Grease Pumps

Hand grease pump for dispensing grease from 25 to 50lb. pail. Maximum outlet pressure : 3500PSI. Includes : Follower plate (107016), 4" high pressure hose, 4 jaw hydraulic coupler and carrying handle. Easily dispense to grease fittings. Delivers 1.2oz. per 28 strokes.

N/S:550	35 LB CONTAINER GREASE PUMP WITH HYDRAULIC COUPLER..1 EACH	\$ 100.05
---------	--	-----------

Hand grease pump for dispensing grease from 25 to 50lb. pail. Maximum outlet pressure : 5000PSI. Includes : Follower plate (107016), 9" low pressure hose, and single shot handle. Spring loaded.

N/S:567	35 LB CONTAINER GREASE PUMP WITH CONTROL HANDLE..1 EACH	\$ 160.12
---------	---	-----------

Other Brands

ALE:7531-4	35LB PAIL MANUAL GREASE PUMP..1 EACH	\$ 233.71
------------	--------------------------------------	-----------

National Spencer Filler Pumps

Greases gun filler pump for 120lb. drum. Pump length : 30". Drum cover diameter : 16". Recommended for grease guns with male loader fitting. Features include : rubber lined follower plate, zinc plated pump, zinc die cast head, cast aluminum adjusting flange, cover and loader fitting and male and female loader adapters. Variable stroke handle allows for delivery of up to 14oz. per 15 strokes.

N/S:327	120 LB CONTAINER GREASE PUMP..1 EACH	\$ 59.28
---------	--------------------------------------	----------

Greases gun filler pump for 25 to 50lb. containers. Pump length : 18". Drum cover diameter : 12". Recommended for grease guns with male loader fitting. Features include : rubber lined follower plate, zinc plated pump, zinc die cast head, cast aluminum adjusting flange, cover and loader fitting and male and female loader adapters. Variable stroke handle allows for delivery of up to 14oz. per 15 strokes.

N/S:328	35 LB CONTAINER GREASE GUN FILLER PUMP..1 EACH	\$ 49.09
---------	--	----------

National Spence Bearing Packers

Portable bearing packer with lever style grease gun (P/N 415AR). Features include : non-threaded top cone for fast placement of bearing, dust cover, extended base and gun holder (P/N 149). Maximum bearing diameter " 6".

N/S:331	PORTABLE BEARING PACKER..1 EACH	\$ 70.79
---------	---------------------------------	----------

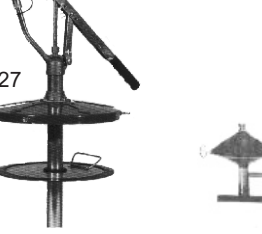
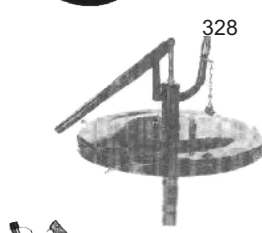
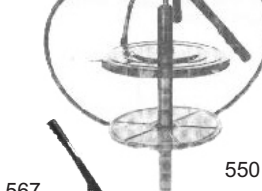
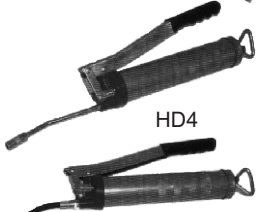

FLUID MANAGEMENT

MANUAL GREASE PUMPS

Variable stroke grease pump and bearing packer for 25 to 50lb. containers. Pump length : 18". Drum cover diameter : 12". Features include : rubber lined follower plate, zinc plated pump, zinc die cast head and powder coated steel cover with adjustable collar. Adjustable pivot point allows for delivery of up to 14oz. per 15 strokes. Maximum bearing diameter : 6".

N/S:333	35 LB CONTAINER BEARING PACKER..1 EACH	\$ 77.06
---------	--	----------

Bench type bearing packer for use with hand or pneumatic grease gun. Features include : non-threaded top cone for fast bearing placement, dust cover and mounting base. Maximum bearing diameter : 6".

N/S:625	BENCH TYPE BEARING PACKER..1 EACH	\$ 29.26
---------	-----------------------------------	----------

AIR OPERATED GREASE PUMPS

National-Spencer Air Operated Hand Held Grease Gun

Pneumatic pistol style grease gun. Maximum pressure : 7000PSI. 40:1 pressure ratio. 1/4"NPT air inlet. Swivel male quick connect fitting. 75 to 100PSI inlet pressure. 1/8"NPT threads. Loading via cartridge, suction or bulk. Heavy duty aluminum die cast head with bulk loader valve. Internal bore precision honed for rapid action. Single shot operation. Delivers 0.6oz. per 40 strokes. Recommended for greases up to NLGI #2.

N/S:910	14 OZ TUBE AIR OPERATED GREASE GUN..1 EACH	\$ 44.18
---------	--	----------

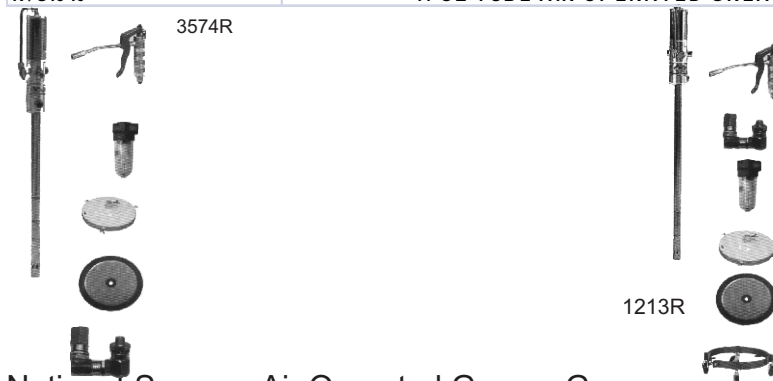

National-Spencer Air Operated Grease Guns

50:1 ratio stationary style pneumatic grease pump system for 25 to 50lb. containers Features includes : control handle (#1536A), air filter (#1559A) with automatic drain, drum cover (#65310), follower plate (#107016), "z" swivel (#1545), durable chrome finish, no oiler needed, 6' high pressure grease hose, 1/4" x 48" air hose, air needle valve and male and female air quick connects. Tube length : 16". Pump tube diameter : 1 3/16". Recommended for grease through NLGI #2. Application : automotive, agricultural and industrial. #3574R-12 comes with a 12' high pressure grease hose.

N/S:3574R	AIR OPERATED 35 LB CONTAINER GREASE PUMP WITH 6' HOSE..1 EACH	\$ 741.23
-----------	---	-----------

N/S:3574R-12	AIR OPERATED 35 LB CONTAINER GREASE PUMP WITH 12' HOSE..1 EACH	\$ 780.34
--------------	--	-----------

60:1 ratio portable style pneumatic grease pump system for 120lb. containers Features includes : control handle (#1536A), air filter (#1559A) with automatic drain, drum cover (#65385), follower plate (#1524), drum dolly (#120-S), "z" swivel (#1545), 1/4" x 6' high pressure grease hose, 1/4" x 48" air hose, air needle valve and male and female air quick connects. Free flow rate : 66oz. per minute. No seals in suction tube eliminates excessive wear. Tube length : 29.13". Pump tube diameter : 1.18". Pump head diameter : 3.15". Pump head length : 13".

Recommended for grease through NLGI #3. Application : dispensing grease short or long distances, suitable for centralized dispensing systems and highly recommended for specific needs requiring a higher quantity of grease and higher pressure. #1213RAR is only the pump.

N/S:1213R	120 LB CONTAINER AIR OPERATED COMPLETE GREASE PUMP..1 EACH	\$ 907.68
-----------	--	-----------

N/S:1213R-00	120 LB AIR OPERATED GREASE PUMP..NO HOSE	\$ 797.64
--------------	--	-----------

N/S:1213R-12	120 LB CONTAINER AIR OPERATED COMPLETE GREASE PUMP..1 EACH	\$ 1057.66
--------------	--	------------

N/S:1213R-16	120 LB CONTAINER AIR OPERATED COMPLETE GREASE PUMP..1 EACH	\$ 926.72
--------------	--	-----------

60:1 ratio pneumatic grease pump system for 400lb. open head drums. Features includes : durable chrome finish, air filter with automatic drain, powder coated drum cover, follower plate with rubber wiper, dual o-ring seals for pump shaft (#66590), air needle valve and male and female air quick connects. Air motor with silicone lube eliminates need for oiler. Double acting for continuous flow. Free flow rate : 66oz. per minute with self loading grease and 90PSI of air. Recommended for most greases including NLGI #3. Application : shop use for dispensing grease to a hose reel or dispensing through a high pressure hose using a control handle.

Recommended optional accessories : hose reel (#1457), booster control handle (#1536A), booster "z" swivel (#1545), continuous flow control handle (#1534), continuous "z" swivel (#1547) and drum dolly (#140-s)

N/S:1212	55:1 400 LB CONTAINER AIR OPERATED GREASE PUMP..1 EACH	\$ 732.57
----------	--	-----------

N/S:1212R	60:1 400 LB CONTAINER AIR OPERATED GREASE PUMP..1 EACH	\$ 733.11
-----------	--	-----------

Other Brands

ALE:9979	AIR OPERATED 400 LB. DRUM GREASE PUMP..1 EACH	\$ 778.37
----------	---	-----------

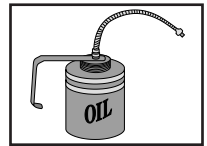

333



625

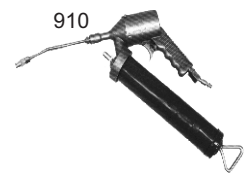

910



1212

MONDAY-FRIDAY
8am-5pm a helpful
HUMAN voice will
always answer the
phone
(770)474-1286

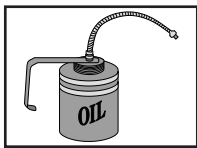

FLUID MANAGEMENT

GREASE DELIVERY ACCESSORIES



N/S 65
ALE B336770

80



ALE 6239



ALE B6783



ALE 6278

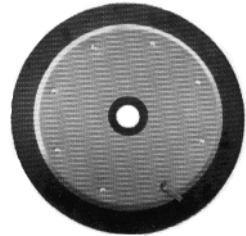

1523
1524

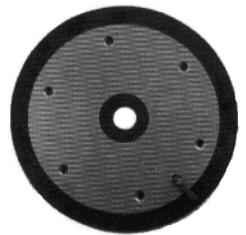

107012
107014
107016
107022

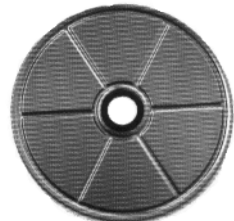

107023

National-Spencer Adapters

Sealed bearing lubricator. Fits grease gun coupler. Needle is only 1-16" x 1 1/2".

N/S:65	SEALED BEARING LUBRICATOR..1 EACH	\$ 2.31
--------	-----------------------------------	---------

Loader nipple. 1/8"NPT male. For filling grease gun filler pump. Fits most grease guns.

N/S:80	GREASE GUN LOADER NIPPLE..1 EACH	\$ 1.81
--------	----------------------------------	---------

Other Adapters

N/S:22	NEEDLE NOSE ADAPTER..1 EACH	\$ 3.84
N/S:23	SEAL-OFF ADAPTER..1 EACH	\$ 4.47
N/S:47SP	RIGHT ANGLE GREASE ADAPTER..1 EACH	\$ 8.84
N/S:48SP	360 SWIVEL ADAPTER..1 EACH	\$ 27.47
N/S:52SP	LOCKING SWIVEL ADAPTER..1 EACH	\$ 29.52
ALE:6239	HYDRAULIC PUSH TYPE ADAPTER..1 EACH	\$ 24.70
ALE:B6783	NEEDLE NOSE ADAPTER..1 EACH	\$ 18.92
ALE:B336770	NEEDLE INJECTOR ADAPTER..1 EACH	\$ 5.86
ALE:6278	SWIVEL ADAPTER..1 EACH	\$ 61.67
CAR:2-8173	1/8" NPT NEEDLE NOSE GREASE ADAPTER..1 EACH	\$ 5.09
THX:418	RIGHT ANGLE GREASE ADAPTER..1 EACH	\$ 11.29

National-Spencer Grease Delivery Hoses

High pressure hose assemblies. Ideal for air operated grease pumps and hose reels. 1/4" ID wire braid. Maximum working pressure : 5000PSI. Maximum burst pressure : 20,000PSI. 1/4"NPT male fittings on both ends.

N/S:1804	1/4 ID X 4' HIGH PRESSURE HOSE 1/4 NPT..1 EACH	\$ 20.33
N/S:1806	1/4 ID X 6' HIGH PRESSURE HOSE 1/4 NPT..1 EACH	\$ 25.69
N/S:1812	1/4 ID X 12' HIGH PRESSURE HOSE 1/4 NPT..1 EACH	\$ 45.30
N/S:1820	1/4 ID X 20' HIGH PRESSURE HOSE 1/4 NPT..1 EACH	\$ 69.16
N/S:1825	1/4 ID X 25' HIGH PRESSURE HOSE 1/4 NPT..1 EACH	\$ 90.45

National-Spencer Follower Plates

Rubber edges for 120lb. drums. 1 7/16" center.

N/S:1523	FOLLOWER PLATE..1 EACH	\$ 32.68
----------	------------------------	----------

Rubber edges for 120lb. drums. 13/16" center.

N/S:1524	FOLLOWER PLATE..1 EACH	\$ 32.68
----------	------------------------	----------

Rubber edges for straight side or tapered 35lb. pails. 1 7/16" center.

N/S:107012	FOLLOWER PLATE..1 EACH	\$ 18.19
------------	------------------------	----------

Rubber edges for straight side or tapered 35lb. pails. 13/16" center.

N/S:107014	FOLLOWER PLATE..1 EACH	\$ 18.19
------------	------------------------	----------

Rubber edges for tapered 35lb. pails. 1" center.

N/S:107016	FOLLOWER PLATE..1 EACH	\$ 18.19
------------	------------------------	----------

Rubber edges. 1 15/16" center.

N/S:107022	FOLLOWER PLATE..1 EACH	\$ 18.19
------------	------------------------	----------

Steel for straight side 35lb. pails. 1 1/2" center.

N/S:107023	FOLLOWER PLATE..1 EACH	\$ 13.65
------------	------------------------	----------

National-Spencer Whip Hoses

Rubber and wire constructed premium quality whip hoses for hand held grease guns. Offers maximum flexibility and longer lasting construction. 1/8"NPT brass fittings.3000PSI rated.

N/S:12R	12" WHIP HOSE..1 EACH	\$ 3.89
N/S:18R	18" WHIP HOSE..1 EACH	\$ 5.99

12" whip hose with 3 ball hydraulic coupler.. For use with mini pistol type grease gun (#180).

N/S:16	12" MINI GREASE GUN WHIP HOSE AND HYDRAULIC COUPLER..1 EACH	\$ 7.33
--------	---	---------

Flexible hose assembly for use with control handles (#1536A). Includes : adapter, hose and coupler. Working pressure : 5000PSI. Burst pressure : 20,000PSI.

N/S:17	WHIP HOSE FOR HIGH PRESSURE GREASE CONTROL HANDLE..1 EACH	\$ 31.22
--------	---	----------

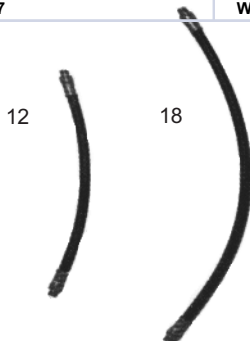

17

FLUID MANAGEMENT



GREASE DELIVERY ACCESSORIES

National-Spencer Hydraulic Couplers

Standard premium quality coupler. Standard 4 jaw hydraulic coupler with ball check. 1/8"NPT female.

N/S:27SP	4 JAW HYDRAULIC COUPLER..1 EACH	\$ 4.12
----------	---------------------------------	---------

Standard premium quality coupler. Standard 3 jaw hydraulic coupler with ball check. 1/8"NPT female.

N/S:28	3 JAW HYDRAULIC COUPLER..1 EACH	\$ 1.98
--------	---------------------------------	---------

Heavy duty premium quality coupler. 3 jaw hydraulic coupler with ball check. 1/8"NPT female.

N/S:25	HEAVY DUTY 3 JAW HYDRAULIC COUPLER..1 EACH	\$ 4.37
--------	--	---------



N/S 27SP
N/S 28SP
N/S 25
ALE B308730

Other Brands

ALE:B6304-B	1/8" STANDARD HYDRAULIC COUPLER..1 EACH	\$ 9.32
ALE:B308730	1/8" NARROW HYDRAULIC COUPLER..1 EACH	\$ 7.14
CAR:2-8168	1/8" NPT HYDRAULIC COUPLER..1 EACH	\$ 1.18

ALE B6509-D



Alemite Swivel Hydraulic Couplers

ALE:B6509-D	1/8" STANDARD SWIVEL HYDRAULIC COUPLER..1 EACH	\$ 39.15
-------------	--	----------

ALE:B6509-E	1/8" NARROW SWIVEL HYDRAULIC COUPLER..1 EACH	\$ 38.88
-------------	--	----------

National-Spencer Control Handles

Continuous flow control handle for dispensing grease from an air operated grease gun. Features include : grease coupler (#28), 1/4"NPT inlet and 1/8"NPT outlet. Maintains same pressure as pump. Continuous flow.

N/S:1534	CONTINUOUS FLOW GREASE CONTROL HANDLE..1 EACH	\$ 52.03
----------	---	----------

Booster control handle for dispensing grease from an air operated grease gun. Features include : grease coupler (#28), 1/8"NPT inlet and 1/8"NPT outlet. Boost pressure to a maximum of 10,000PSI.

N/S:1536A	HIGH PRESSURE GREASE CONTROL HANDLE..1 EACH	\$ 74.57
-----------	---	----------



1534

Other Brands

ALE:6320-3	STANDARD CONTROL VALVE..1 EACH	\$ 138.65
------------	--------------------------------	-----------

National-Spencer Swivel

Booster "z" swivel for use with control handle #1536.

N/S:1545	HIGH PRESSURE GREASE Z-SWIVEL..1 EACH	\$ 33.14
----------	---------------------------------------	----------

Other Brands

ALE:B331107	1/4" X 1/4" GREASE Z-SWIVEL..1 EACH	\$ 122.28
ALE:B321320	1/4" X 1/4" STRAIGHT GREASE SWIVEL..1 EACH	\$ 24.75

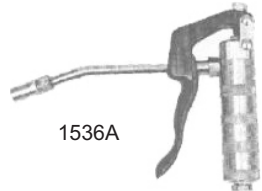

1536A

DRAIN PANS

National-Spencer Galvanized Drain Pans

4" deep x 15" diameter

N/S:721	3 1/2 GAL GALVANIZED DRAIN PAN..1 EACH	\$ 7.75
---------	--	---------

6" deep x 18.5: diameter

N/S:723	7 GAL GALVANIZED DRAIN PAN..1 EACH	\$ 30.10
---------	------------------------------------	----------

Other Brands

CAR:AT21-12	3 GAL DRAIN PAN..1 EACH	\$ 4.50
CAR:AT22-12	18" X 25" DRIP PAN..1 EACH	\$ 4.87
G/C:05070	7.5 QT PLASTIC DRAIN PAN..1 EACH	\$ 1.39
G/C:11838	15 QT PLASTIC RECOVERY DRAIN PAN..1 EACH	\$ 10.23
G/C:11845	5 GAL PLASTIC DRAIN PAN..1 EACH	\$ 12.91

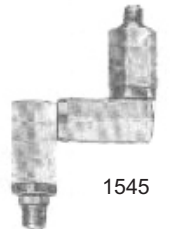

1545

National-Spencer Telescopic Oil Drains

8 Gallon oil drain. Adjust from 44.5" to 67".

N/S:309	8 GAL TELESCOPIC DRAIN..1 EACH	\$ 75.93
---------	--------------------------------	----------

16 gallon oil drain. Used to convert a 16gallon or 120lb. open head drum (not included) into a lift drain. Included : drum cover (#107027-A-PCR), 67.5" drain pipe and 14" steel funnel. For gravity drain of fluids when using an auto lift or over a pit. Optional accessory : drum dolly (#120-S).

N/S:312	16 GAL TELESCOPIC DRAIN (DRUM NOT INCLUDED)..1 EACH	\$ 97.39
---------	---	----------

Used to convert a 16gallon or 55 gallon drum (not included) with a 2" bung into a lift drain. Included : 67.5" drain pipe, 14" steel funnel, and 2" bung adapter.. For gravity drain of fluids when using an auto lift or over a pit.

N/S:315	55 GAL TELESCOPIC DRAIN (DRUM NOT INCLUDED)..1 EACH	\$ 66.04
---------	---	----------

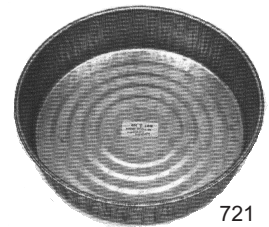

721



312
315



309

723



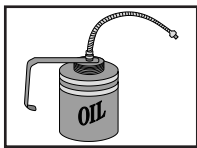

FLUID MANAGEMENT

DRAIN PANS

National-Spencer Telescopic Oil Drains With Casters

8 gallon oil drain with 3.5" casters. Adjust from 44.5" to 67".

N/S:316	8 GAL TELESCOPIC DRAIN WITH CASTERS..1 EACH	\$ 89.26
---------	---	----------

18 gallon oil drain with 3.5" casters. Adjust from 44.5 to 67". Garden hose drain valve on side. 2"NPT bung opening.

N/S:318	18 GAL TELESCOPIC DRAIN WITH CASTERS..1 EACH	\$ 145.52
---------	--	-----------

National-Spencer Replacement Funnel

Polyethylene universal replacement funnel for portable oil drains. Fits 1 1/2" to 1 7/8" ID tube. Fits model numbers 309, 316 and 318.

N/S:699	18" UNIVERSAL REPLACEMENT FUNNEL..1 EACH	\$ 42.05
---------	--	----------

316
318



699

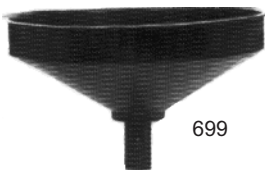

237



1235

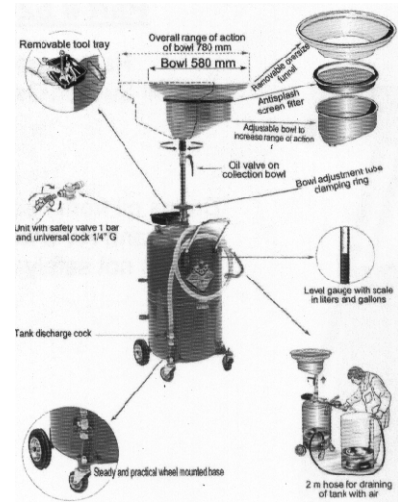
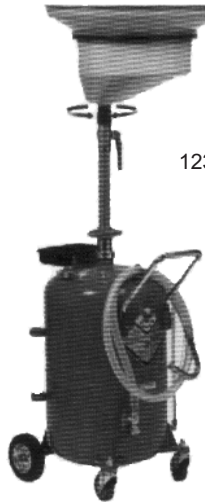

National-Spencer Waste Oil Drain

17 gallon waste oil drain. Adjustable height : minimum 49 1/2" / maximum 69". Mounted on front and rear ball bearing wheels (3" front casters, 6" rear casters). Central mounted bowl on swivel joint for positioning. Tank hold 13 3/4 gallons and collection bowl holds 3 1/2 gallons. 22 1/2" oversized funnel. 6 1/2" drain hose. 7PSI maximum draining air pressure. Level sight glass, scale in liters and gallons. Anti-splash screen/filter useful for draining oil filters. Attachable tool tray (6" x 8" x 2"). Used for gravity drain of fluids from engines, gear boxes or differentials of all motor vehicles placed on an auto lift or over a pit. Procedure for self evacuation : (1) close all valves and raise funnel until it clicks (2) apply air to tank (3) once pressurized roll tank to discharge location (4) place drain tube in waste oil container (5) open valve at opposite end of drain tube.

N/S:1235	17 GAL TELESCOPIC WASTE OIL DRAIN..1 EACH	\$ 484.77
----------	---	-----------

17 gallon truck oil drain. Used for draining oil and antifreeze from heavy-duty trucks and Rvs where a lift drain is not suitable. It has an 8" high x 25" wide x 46" long translucent body that fluid levels are easily viewed through. Used oil is transferred via a 115V, 4 GPM pump. It comes with 2 rear stationary wheels for stability, 2 large swivel casters, and a 6' hose.

N/S:237	17 GAL LOWBOY TRUCK OIL DRAIN..1 EACH	\$ 823.90
---------	---------------------------------------	-----------

OIL CANS

National-Spencer Oilers

Red pistol action oiler. 6" rigid steel pipe and deep drawn seamless body.

N/S:93	6 OZ PISTOL PUMP OILER..1 EACH	\$ 6.18
--------	--------------------------------	---------

Red pistol action oiler. 6" rigid steel pipe and deep drawn seamless body.

N/S:95	10 OZ PISTOL PUMP OILER..1 EACH	\$ 7.17
--------	---------------------------------	---------

National-Spencer Galvanized Oil Cans

Hot dip, double seamed 1 quart measurer with rigid spout.

N/S:709	1 QT GALVANIZED MEASURER WITH RIGID SPOUT..1 EACH	\$ 15.76
---------	---	----------

Hot dip, double seamed 2 quart measurer with rigid spout.

N/S:711	2 QT GALVANIZED MEASURER WITH RIGID SPOUT..1 EACH	\$ 20.76
---------	---	----------

Hot dip, double seamed 4 quart measurer with rigid spout.

N/S:713	4 QT GALVANIZED MEASURER WITH RIGID SPOUT..1 EACH	\$ 22.61
---------	---	----------

709
711
713



FLUID MANAGEMENT



OIL CANS

Hot dip, double seamed 2 quart measurer with flexible spout.

N/S:717	2 QT GALVANIZED MEASURER WITH FLEXIBLE SPOUT..1 EACH	\$ 21.16
---------	--	----------

Hot dip, double seamed 4 quart measurer with flexible spout.

N/S:719	4 QT GALVANIZED MEASURER WITH FLEXIBLE SPOUT..1 EACH	\$ 26.82
---------	--	----------

National-Spencer Flow Control Oil Cans

4 quart flow control measurer. 12: flexible spout. 1/2" diameter outlet. Black enamel finish. Non splash rim.

Marked in quarts and liters. One handed flow control valve.

N/S:743	4 QT GALVANIZED FLOW CONTROL MEASURER..1 EACH	\$ 78.67
---------	---	----------

5 quart flow control measurer. 12: flexible spout. 1/2" diameter outlet. Black enamel finish. Non splash rim.

Marked in quarts and liters. One handed flow control valve

N/S:745	5 QT GALVANIZED FLOW CONTROL MEASURER..1 EACH	\$ 85.98
---------	---	----------

National-Spencer Plastic Oil Cans

1 quart plastic measure. Translucent polyethylene construction. Marked in quarts and liters. Flexible spout.

N/S:751	1 QT POLY MEASURER WITH FLEXIBLE SPOUT..1 EACH	\$ 5.98
---------	--	---------

2 quart plastic measure. Translucent polyethylene construction. Marked in quarts and liters. Flexible spout

N/S:753	2 QT POLY MEASURER WITH FLEXIBLE SPOUT..1 EACH	\$ 7.41
---------	--	---------

5 quart plastic measure. Translucent polyethylene construction. Marked in quarts and liters. Flexible spout

N/S:757	5 QT POLY MEASURER WITH FLEXIBLE SPOUT..1 EACH	\$ 13.34
---------	--	----------

Replacement spout

N/S:SPOUT	FLEXIBLE SPOUT FOR POLY MEASURERS..1 EACH	\$ 1.83
-----------	---	---------



717
719

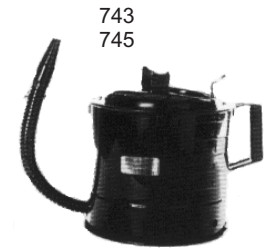

743
745

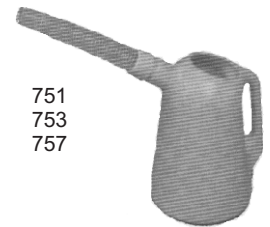

751
753
757

FUNNELS

National-Spencer Transmission Funnel

Flexible. 14" galvanized plated transmission funnel with screen.

N/S:701	1 QT GALVANIZED FUNNEL WITH SCREEN..1 EACH	\$ 5.83
---------	--	---------

Other Brands

G/C:06064	PLASTIC TRANSMISSION FUNNEL..1 EACH	\$ 1.00
-----------	-------------------------------------	---------

G/C:6064B	PLASTIC TRANSMISSION FUNNEL..1 EACH	\$ 1.55
-----------	-------------------------------------	---------

National-Spencer Galvanized Funnels

1 quart galvanized funnel with screen. 1/2" outlet.

N/S:86	14" GALVANIZED FLEXIBLE TRANSMISSION FUNNEL..1 EACH	\$ 8.08
--------	---	---------

8 quart galvanized lock on type funnel with screen. 1" outlet. 6" deep x 9 1/2" diameter.

N/S:703	8 QT GALVANIZED LOCK ON FUNNEL WITH SCREEN..1 EACH	\$ 18.80
---------	--	----------

5 quart galvanized offset type funnel with screen. 1" outlet. 8" diameter.

N/S:705	5 QT GALVANIZED OFF SET FUNNEL WITH SCREEN..1 EACH	\$ 21.63
---------	--	----------

8 quart galvanized funnel with screen. 1" outlet. 12" diameter.

N/S:707	9 QT GALVANIZED FUNNEL WITH SCREEN..1 EACH	\$ 19.40
---------	--	----------

National-Spencer Plastic Funnels

6" diameter heavy duty polyethylene funnel with screen. Anti-splash rim. 7" long x 1/2" diameter flexible spout.

N/S:759	6" POLY FUNNEL WITH SCREEN..1 EACH	\$ 9.96
---------	------------------------------------	---------

9" diameter heavy duty polyethylene funnel with screen. Anti-splash rim. 9" long x 7/8" diameter flexible spout.

N/S:761	9" POLY FUNNEL WITH SCREEN..1 EACH	\$ 11.92
---------	------------------------------------	----------

10" x 7" square top heavy duty polyethylene funnel with screen. 1 1/16" outlet.

N/S:763	7" X 10" POLY FUNNEL WITH SCREEN..1 EACH	\$ 8.85
---------	--	---------

Deluxe plastic funnel. 11" flexible spout. Wide neck for rapid filling. Handy in hard to reach areas.

N/S:770	11" FLEXIBLE FUNNEL..1 EACH	\$ 5.05
---------	-----------------------------	---------

4 1/2" diameter one piece king size plastic funnel. 17" long. 5/8" outlet.

N/S:775	17" KING SIZE FUNNEL..1 EACH	\$ 2.85
---------	------------------------------	---------



86

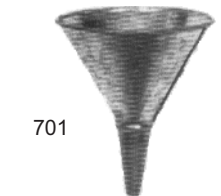

701

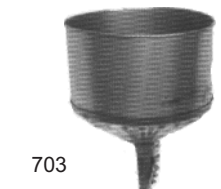

703



759



761



763



770



775

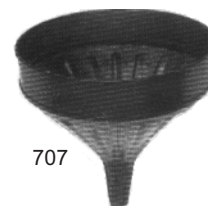

707



705

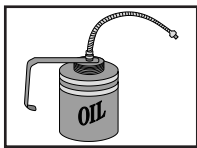

FLUID MANAGEMENT

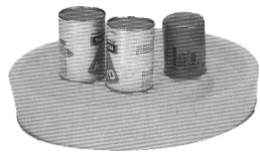

772

FUNNELS

Other Brands (plastic funnels)

G/C:05007	1/2 PT PLASTIC FUNNEL..1EACH	\$ 0.53
G/C:05008	1/2 PT PLASTIC FUNNEL..1EACH	\$ 0.35
G/C:5015B	1 PT PLASTIC FUNNEL..1EACH	\$ 0.69
G/C:05016	1 PT PLASTIC FUNNEL..1EACH	\$ 0.46
G/C:05064	1 QT PLASTIC FUNNEL..1EACH	\$ 3.36
G/C:05034	18" SUPER PLASTIC FUNNEL..1EACH	\$ 1.00
G/C:02369	LARGE PLASTIC FUNNEL..1EACH	\$ 26.56

National-Spencer Specialty Funnels

55 gallon drum funnel that permits drainage into a drum. Ideal for oil filters, oil bottles, and drain pans. Durable polyethylene will not rust.

N/S:772	55 GAL DRUM TOP FUNNEL..1EACH	\$ 66.43
---------	-------------------------------	----------

10" x 7" square top heavy duty polyethylene diesel fuel funnel with screen. 1 1/16" outlet. Special screen separates water droplets from fuel.

N/S:764	7" X 10" POLY FUNNEL WITH FUEL SCREEN..1EACH	\$ 10.27
---------	--	----------



764

Other Brands

G/C:28210	POLY SPILL CONTAINMENT FUNNEL..1EACH	\$ 40.57
G/C:TOD2400-14	POLY OIL FILTER DRAIN FUNNEL..1EACH	\$ 46.64

FUEL STORAGE

National-Spencer Gas Caddy

Gas caddy. Constructed with cross-linked polyethylene. Molded in baffle for strength and durability. Includes rotary pump, 10' rubber hose, dispensing nozzle and pneumatic tires with nylon bearings. UL listed pump and DOT rated tank.

N/S:319	28 GAL COMPLETE GAS CADDY..1EACH	\$ 873.09
---------	----------------------------------	-----------

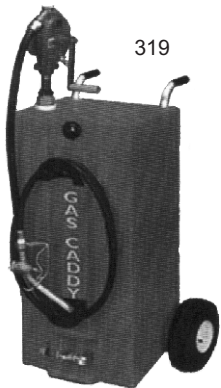

319

Terne Plate Safety Fuel Cans

These cans are designed with one spout used for both filling and pouring. They are designed to pour flammable liquids into larger openings. When you add the funnel/hose attachment you get accurate pouring into smaller places.

G/C:10301	1 GAL SAFETY GAS CAN..1EACH	\$ 30.92
G/C:10501	2 GAL SAFETY GAS CAN..1EACH	\$ 43.98
G/C:10701	3 GAL SAFETY GAS CAN..1EACH	\$ 46.63
G/C:10702	3 GAL SAFETY GAS CAN WITH FUNNEL..1EACH	\$ 61.88
G/C:10801	5 GAL SAFETY GAS CAN..1EACH	\$ 22.63
G/C:10802	5 GAL SAFETY GAS CAN WITH FUNNEL..1EACH	\$ 49.99
G/C:U-150-FSY	5 GAL SAFETY DIESEL CAN WITH FUNNEL..1EACH	\$ 56.16
G/C:10821	20 QT SAFETY FILL CAN..1EACH	\$ 70.70
G/C:11200	SAFETY GAS CAN FUNNEL..1EACH	\$ 10.04

Plastic Fuel Cans

G/C:50805	1 GAL PLUS GAS CAN WITH SPOUT..1EACH	\$ 8.95
G/C:50810	2 GAL PLUS GAS CAN WITH SPOUT..1EACH	\$ 11.33
G/C:85023	2.5 GAL "EPA APPROVED" GAS CAN..1EACH	\$ 12.83
G/C:50833	5 GAL GAS CAN WITH SPOUT..1EACH	\$ 18.50
G/C:50877	5 GAL KEROSENE CAN..1EACH	\$ 20.82

FUEL NOZZLES

National-Spencer Fuel Nozzles

Manual fuel nozzle for dispensing gasoline and diesel fuel. Straight spout. 1" inlet and 1" outlet

N/S:1537	1" MANUAL FUEL NOZZLE..1EACH	\$ 21.28
----------	------------------------------	----------

Manual fuel nozzle for dispensing gasoline and diesel fuel. Straight spout. 3/4" inlet and 3/4" outlet

N/S:1538	3/4" MANUAL FUEL NOZZLE..1EACH	\$ 21.28
----------	--------------------------------	----------

Manual fuel nozzle for dispensing gasoline and diesel fuel. Straight spout. 1" inlet and 3/4" outlet

N/S:1539	1" MANUAL FUEL NOZZLE..1EACH	\$ 21.29
----------	------------------------------	----------

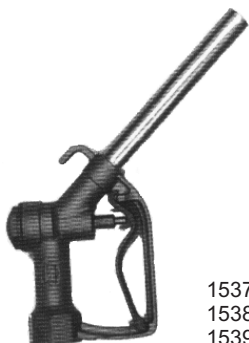

1537
1538
1539

FLUID MANAGEMENT



HOSE ASSEMBLIES

National-Spencer Hose Assemblies

Clear vinyl hose. 1/2" x 5'. Garden hose connection. Open discharge. For use with models : D-S, 338, 366 and 381

N/S:36	1/2 ID X 5' CLEAR VINYL HOSE..1 EACH	\$ 10.29
--------	--------------------------------------	----------

Clear vinyl hose. 1/2" x 8'. Garden hose connection. Curved discharge spout. For use with models : D-S, 338, 366 and 381

N/S:88	1/2 ID X 8' CLEAR VINYL HOSE..1 EACH	\$ 20.00
--------	--------------------------------------	----------

Clear vinyl hose. 3/4" x 4'. 3/4"NPT female connection. Open discharge. For use with models : 906 and 1002.

N/S:2154	3/4 ID X 4' CLEAR VINYL HOSE..1 EACH	\$ 15.44
----------	--------------------------------------	----------

Clear vinyl hose. 3/4" x 4'. Coupling nut connection. Plastic nozzle discharge. For use with models : 360, 362, 363 and 365

N/S:2134	3/4 ID X 4' PLASTIC PUMP HOSE..1 EACH	\$ 14.17
----------	---------------------------------------	----------

Clear vinyl hose. 3/4" x 6'. Coupling nut connection. Plastic nozzle discharge. For use with models : 360, 362, 363 and 365

N/S:2136	3/4 ID X 6' PLASTIC PUMP HOSE..1 EACH	\$ 16.73
----------	---------------------------------------	----------

Black rubber hose. 3/4" x 8'. 3/4"NPT male connection. 3/4"NPT male discharge. For use with models : 30-A1.

N/S:L30-95N	3/4 ID X 8' BLACK RUBBER HOSE..1 EACH	\$ 33.24
-------------	---------------------------------------	----------

Black rubber hose. 3/4" x 8'. 3/4"NPT female connection. Aluminum nozzle discharge. For use with models : 960, 962 and 1007

N/S:2178	3/4 ID X 8' ROTARY PUMP HOSE..1 EACH	\$ 34.58
----------	--------------------------------------	----------

Nitrile/PVC blend hose. 3/4" x 12'. 3/4"NPT male connection. 3/4"NPT male discharge. For use with models : 926, 927, 928 and 933

N/S:10039-1	12' X 3/4" FUEL HOSE..1 EACH	\$ 42.43
-------------	------------------------------	----------

Medium pressure hose assembly. Ideal for air operated oil pumps & hose reels. 1/2" I.D. Fiber braid Maximum working pressure 1,125 lbs. Minimum burst pressure 4,500 lbs. 1/2" NPT male pressure fittings on both ends.

N/S:2210	1/2 ID X 10' MEDIUM PRESSURE HOSE 1/2 NPT..1 EACH	\$ 60.74
----------	---	----------

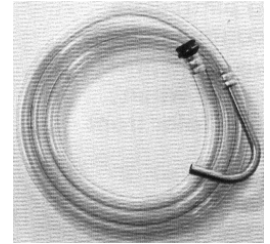

36 / 88 / 2154
2134 / 2136



L30-95N / 2178



10039-1

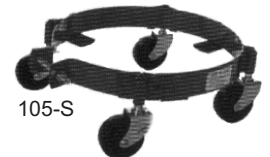

105-S



120-S



138-S



140-S

ACCESSORIES

National-Spencer Dollies

5 - 6 1/2 gallon pail dolly. Steel casters. 10" to 11 5/8" diameter. Maximum load 200lbs.

N/S:105-S	BAND DOLLY FOR PAILS..1 EACH	\$ 41.43
-----------	------------------------------	----------

16 gallon or 120lb. drum dolly. Steel casters. 13" to 14 1/4" diameter. Maximum load 200lbs.

N/S:120-S	BAND DOLLY FOR KEGS..1 EACH	\$ 46.11
-----------	-----------------------------	----------

55 gallon drum dolly. Steel casters. 23" diameter. Maximum load 450lbs.

N/S:138-S	LIP DOLLY FOR DRUMS..1 EACH	\$ 70.24
-----------	-----------------------------	----------

55 gallon drum dolly. Steel casters. 23" diameter. Maximum load 450lbs. Raised sides.

N/S:140-S	BAND DOLLY FOR DRUMS..1 EACH	\$ 89.05
-----------	------------------------------	----------

4 wheel trolley for carrying 16 gallon to 55 gallon drums with a hose reel.

N/S:148	4 WHEEL DRUM 16 TO 55 GAL DRUM CARRYING CART..1 EACH	\$ 254.67
---------	--	-----------

National-Spencer Drum Cradle

Drum cradle with axle and wheels. Tips and rotates. Self leveling bar. 600 lb. capacity.

N/S:135	TILTING DRUM CRADLE..1 EACH	\$ 89.32
---------	-----------------------------	----------

National-Spencer Drum Wrench

Aluminum drum wrench. Non-sparking. Opens both 3/1" and 2" bungs.

N/S:169	DRUM PLUG WRENCH..1 EACH	\$ 11.48
---------	--------------------------	----------

Other Brands

G/C:08805	BUNG WRENCH..1 EACH	\$ 22.06
-----------	---------------------	----------



169

135



148





FLUID MANAGEMENT

ACCESSORIES

National-Spencer Bung Faucets

Polyethylene bung faucet for 2"NPT opening. Empties 55 gallon drum in 3 minutes. Instant on/of control.

N/S:67	2" POLY BUNG FAUCET..1 EACH	\$ 15.01
--------	-----------------------------	----------

Cast iron constructed bung faucet with 2"NPT threads. Manually operated. Comes with holes for a pad lock.

N/S:64	2" CAST IRON BUNG FAUCET..1 EACH	\$ 58.17
--------	----------------------------------	----------

Polyethylene bung faucet for 3/4"NPT opening. Chemical resistant. Instant on/of control.

N/S:68	3/4" POLY BUNG FAUCET..1 EACH	\$ 3.78
--------	-------------------------------	---------

Die-cast metal bung faucet for 3/4"NPT opening. Self closing. Comes with holes for a pad lock.

N/S:81	3/4" DIE CAST BUNG FAUCET..1 EACH	\$ 10.06
--------	-----------------------------------	----------

National-Spencer Pump Accessories

Non drip attachment for D-S pump.

N/S:D01	NON DRIP ATTACHMENT FOR BARREL PUMPS..1 EACH	\$ 7.29
---------	--	---------

Other Accessories

N/S:106025	DRUM PUMP COLLAR..1 EACH	\$ 2.18
N/S:65385	120 LB CONTAINER DRUM COVER..1 EACH	\$ 38.89
N/S:501-145	BUNG ADAPTOR..1 EACH	\$ 4.57
N/S:L30-79N	BUNG ADAPTER..1 EACH	\$ 5.33
N/S:110100-1	SUCTION TUBE ASSEMBLY..1 EACH	\$ 33.93
N/S:L30-30N	DIAPHRAGM FOR HAND PUMP..1 EACH	\$ 20.22
N/S:21	CUT OFF VALVE..1 EACH	\$ 7.42
N/S:502-308	VEIN FOR PUMP..1 EACH	\$ 25.53
N/S:S502-306	REPLACEMENT SEAL FOR 1002 & 1003 PUMPS..1 EACH	\$ 1.66
N/S:S502-305	REPLACEMENT GASKET FOR 1002 & 1003 PUMPS..1 EACH	\$ 1.89
G/C:08552	2" GATE VALVE..1 EACH	\$ 107.04
ALE:P-UP-TUBE	PICK UP TUBE FOR PUMP..1 EACH	\$ 25.99
CLN:EMPTY-DRUM -30G	EMPTY 30 GAL DRUM..1 EACH	\$ 30.00
CLN:EMPTY-DRUM	EMPTY 55 GAL DRUM..1 EACH	\$ 20.00
CLN:DRUM -BLUE	WHITE USED EMPTY 55 GAL DRUM..1 EACH	\$ 20.00
CLN:TOTE	USED 275 GAL TOTE..1 EACH	\$ 187.50

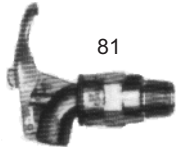
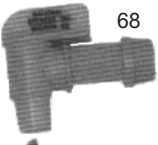
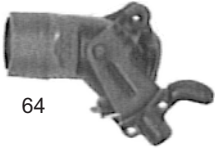
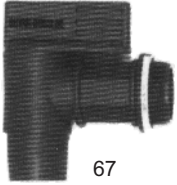

NATIONAL-SPENCER, INC.



Ask your Parker Brothers
Salesman
for a complete National-Spencer
catalog



ELECTRICAL SUPPLIES

FUSES

FUSE HOLDERS

CIRCUIT BREAKERS

FUSE ASSORTMENTS

WIRE

ELECTRICAL CONNECTORS AND TERMINALS

ELECTRICAL TERMINAL ASSORTMENTS

BATTERY SUPPLIES

WIRE WEATHERPROOFING

WIRE MANAGEMENT

WIRE MARKERS

PARKER BROTHERS, INC.

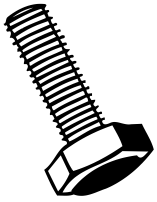

Mystik
The Ultimate
In Fine
Lubrication

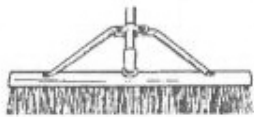

NATIONAL-SPENCER, INC.



Permatex



ELECTRICAL SUPPLIES



FUSES

Littelfuse Blade Fuses

The ATO fuse has been the international fuse standard since 1981. It is found on almost all cars, trucks, buses, and off road vehicles.

FUS:AT03	BLADE FUSES..5 PER BOX	\$ 2.99
FUS:AT04	BLADE FUSES..5 PER BOX	\$ 2.71
FUS:AT05	BLADE FUSES..5 PER BOX	\$ 3.17
FUS:AT07-1/2	BLADE FUSES..5 PER BOX	\$ 5.90
FUS:AT010	BLADE FUSES..5 PER BOX	\$ 2.71
FUS:AT015	BLADE FUSES..5 PER BOX	\$ 3.08
FUS:AT020	BLADE FUSES..5 PER BOX	\$ 2.71
FUS:AT025	BLADE FUSES..5 PER BOX	\$ 2.71
FUS:AT030	BLADE FUSES..5 PER BOX	\$ 2.71
FUS:AT040	BLADE FUSES..5 PER BOX	\$ 2.71

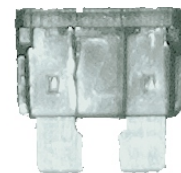

ATO FUSE



MINI FUSE

The MINI fuse is designed to protect a greater number of circuits without utilizing more space.

FUS:MIN2	SMALL BLADE FUSES..5 PER BOX	\$ 1.60
FUS:MIN3	SMALL BLADE FUSES..5 PER BOX	\$ 1.96
FUS:MIN4	SMALL BLADE FUSES..5 PER BOX	\$ 1.96
FUS:MIN5	SMALL BLADE FUSES..5 PER BOX	\$ 1.53
FUS:MIN7-1/2	SMALL BLADE FUSES..5 PER BOX	\$ 1.53
FUS:MIN10	SMALL BLADE FUSES..5 PER BOX	\$ 1.56
FUS:MIN15	SMALL BLADE FUSES..5 PER BOX	\$ 1.11
FUS:MIN20	SMALL BLADE FUSES..5 PER BOX	\$ 1.56
FUS:MIN25	SMALL BLADE FUSES..5 PER BOX	\$ 1.60
FUS:MIN30	SMALL BLADE FUSES..5 PER BOX	\$ 1.56

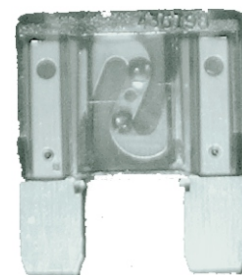

MAXI FUSE

The LMINI fuse is protects as many circuits as the MINI fuse but uses less space.

FUS:LMIN2	LOW SMALL BLADE FUSES..5 PER BOX	\$ 2.99
FUS:LMIN5	LOW SMALL BLADE FUSES..5 PER BOX	\$ 2.99
FUS:LMIN7-1/2	LOW SMALL BLADE FUSES..5 PER BOX	\$ 2.99
FUS:LMIN10	LOW SMALL BLADE FUSES..5 PER BOX	\$ 2.99
FUS:LMIN15	LOW SMALL BLADE FUSES..5 PER BOX	\$ 2.99
FUS:LMIN20	LOW SMALL BLADE FUSES..5 PER BOX	\$ 2.99
FUS:LMIN25	LOW SMALL BLADE FUSES..5 PER BOX	\$ 2.99
FUS:LMIN30	LOW SMALL BLADE FUSES..5 PER BOX	\$ 2.99

The MAXI fuse replaces commonly used fusible wire or links to protect a high current segment or system of the wiring harness

FUS:MAX20	LARGE BLADE FUSE..1PER BOX	\$ 1.89
FUS:MAX30	LARGE BLADE FUSE..1PER BOX	\$ 1.89
FUS:MAX40	LARGE BLADE FUSE..1PER BOX	\$ 1.89
FUS:MAX50	LARGE BLADE FUSE..1PER BOX	\$ 1.89
FUS:MAX60	LARGE BLADE FUSE..1PER BOX	\$ 1.89
FUS:MAX70	LARGE BLADE FUSE..1PER BOX	\$ 2.24
FUS:MAX80	LARGE BLADE FUSE..1PER BOX	\$ 2.24

The JCASE high amp fuse is designed to replace MAXI fuses and other cartridge style fuses. OEM on many Japanese models. Smaller space saving footprint is being designed by many OEM's.

FUS:JCAS20	HIGH AMP FUSE	\$ 2.90
FUS:JCAS30	HIGH AMP FUSE	\$ 2.90
FUS:JCAS40	HIGH AMP FUSE	\$ 2.90
FUS:JCAS50	HIGH AMP FUSE	\$ 2.90
FUS:JCAS60	HIGH AMP FUSE	\$ 2.90

FOR 50+ YEARS,
PARKER
BROTHERS
HAS BEEN
SERVING ATLANTA.
**THANK YOU FOR
YOUR CONTINUED
SUPPORT!!**

PARKER, BROTHERS, INC.



ELECTRICAL SUPPLIES

FUSES

Littelfuse Bolt-On Fuses

These fuses are used in vehicles for high current applications where tighter bolt-down connections substantially reduces or eliminates heat. The PAL fuse is an alternative to the MAXI fuse in current ratings up to 120amperes. It is commonly found on Japanese vehicles.

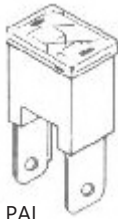

PAL

FUS:PAL020	AUTO LINK PAL FUSE	\$ 2.11
FUS:PAL030	AUTO LINK PAL FUSE	\$ 2.11
FUS:PAL040	AUTO LINK PAL FUSE	\$ 2.11
FUS:PAL050	AUTO LINK PAL FUSE	\$ 2.11
FUS:PAL060	AUTO LINK PAL FUSE	\$ 2.11
FUS:PAL100	AUTO LINK PAL FUSE	\$ 2.11
FUS:PAL130	AUTO LINK PAL FUSE	\$ 2.13
FUS:PAL160	AUTO LINK PAL FUSE	\$ 2.13
FUS:PAL180	AUTO LINK PAL FUSE	\$ 2.13
FUS:PAL230	AUTO LINK PAL FUSE	\$ 2.11
FUS:PAL240	AUTO LINK PAL FUSE	\$ 2.11
FUS:PAL250	AUTO LINK PAL FUSE	\$ 2.11
FUS:PAL260	AUTO LINK PAL FUSE	\$ 2.11
FUS:PAL270	AUTO LINK PAL FUSE	\$ 2.11
FUS:PAL280	AUTO LINK PAL FUSE	\$ 2.11
FUS:PAL330	AUTO LINK PAL FUSE	\$ 2.11
FUS:PAL340	AUTO LINK PAL FUSE	\$ 2.11

Littelfuse Glass Fuses

These fuses were designed into North American vehicles prior to 1981. The AG fuses vary in length and diameter according to amperage.

FUS:AGA2	1/4" X 5/8" GLASS FUSES..5 PER BOX	\$ 1.50
FUS:AGA2-1/2	1/4" X 5/8" GLASS FUSES..5 PER BOX	\$ 1.50
FUS:AGA3	1/4" X 5/8" GLASS FUSES..5 PER BOX	\$ 1.50
FUS:AGA5	1/4" X 5/8" GLASS FUSES..5 PER BOX	\$ 0.94
FUS:AGA6	1/4" X 5/8" GLASS FUSES..5 PER BOX	\$ 0.94
FUS:AGA7-1/2	1/4" X 5/8" GLASS FUSES..5 PER BOX	\$ 0.94
FUS:AGA10	1/4" X 5/8" GLASS FUSES..5 PER BOX	\$ 0.94
FUS:AGA20	1/4" X 5/8" GLASS FUSES..5 PER BOX	\$ 0.94
FUS:AGA25	1/4" X 5/8" GLASS FUSES..5 PER BOX	\$ 0.94
FUS:AGA30	1/4" X 5/8" GLASS FUSES..5 PER BOX	\$ 0.94
FUS:AGC1	1/4" X 1 1/4" GLASS FUSES..5 PER BOX	\$ 1.29
FUS:AGC1-1/2	1/4" X 1 1/4" GLASS FUSES..5 PER BOX	\$ 1.31
FUS:AGC2	1/4" X 1 1/4" GLASS FUSES..5 PER BOX	\$ 1.29
FUS:AGC2-1/2	1/4" X 1 1/4" GLASS FUSES..5 PER BOX	\$ 1.31
FUS:AGC3	1/4" X 1 1/4" GLASS FUSES..5 PER BOX	\$ 1.29
FUS:AGC4	1/4" X 1 1/4" GLASS FUSES..5 PER BOX	\$ 1.31
FUS:AGC5	1/4" X 1 1/4" GLASS FUSES..5 PER BOX	\$ 0.94
FUS:AGC6	1/4" X 1 1/4" GLASS FUSES..5 PER BOX	\$ 0.94
FUS:AGC7-1/2	1/4" X 1 1/4" GLASS FUSES..5 PER BOX	\$ 0.94
FUS:AGC10	1/4" X 1 1/4" GLASS FUSES..5 PER BOX	\$ 0.94
FUS:AGC15	1/4" X 1 1/4" GLASS FUSES..5 PER BOX	\$ 0.95
FUS:AGC20	1/4" X 1 1/4" GLASS FUSES..5 PER BOX	\$ 0.95
FUS:AGC25	1/4" X 1 1/4" GLASS FUSES..5 PER BOX	\$ 0.94
FUS:AGC30	1/4" X 1 1/4" GLASS FUSES..5 PER BOX	\$ 0.95
FUS:AGC35	1/4" X 1 1/4" GLASS FUSES..5 PER BOX	\$ 1.40
FUS:AGW1	1/4" X 7/8" GLASS FUSES..5 PER BOX	\$ 1.59
FUS:AGW1-1/2	1/4" X 7/8" GLASS FUSES..5 PER BOX	\$ 1.59
FUS:AGW2-1/2	1/4" X 7/8" GLASS FUSES..5 PER BOX	\$ 1.59
FUS:AGW3	1/4" X 7/8" GLASS FUSES..5 PER BOX	\$ 1.59
FUS:AGW4	1/4" X 7/8" GLASS FUSES..5 PER BOX	\$ 1.59
FUS:AGW5	1/4" X 7/8" GLASS FUSES..5 PER BOX	\$ 1.03
FUS:AGW6	1/4" X 7/8" GLASS FUSES..5 PER BOX	\$ 1.03
FUS:AGW15	1/4" X 7/8" GLASS FUSES..5 PER BOX	\$ 1.03
FUS:AGW20	1/4" X 7/8" GLASS FUSES..5 PER BOX	\$ 1.03
FUS:AGW30	1/4" X 7/8" GLASS FUSES..5 PER BOX	\$ 1.03



ELECTRICAL SUPPLIES



FUSES

The SFE fuse have a 1/4" diameter but vary in length according to amperage.

FUS:AGX20	1/4" X 1" GLASS FUSES..5 PER BOX	\$ 1.12
FUS:AGX25	1/4" X 1" GLASS FUSES..5 PER BOX	\$ 1.12
FUS:AGX30	1/4" X 1" GLASS FUSES..5 PER BOX	\$ 1.12
FUS:SFE4	1/4" X 5/8" GLASS FUSES..5 PER BOX	\$ 0.94
FUS:SFE6	1/4" X 3/4" GLASS FUSES..5 PER BOX	\$ 0.94
FUS:SFE7-1/2	1/4" X 7/8" GLASS FUSES..5 PER BOX	\$ 0.94
FUS:SFE9	1/4" X 15/16" GLASS FUSES..5 PER BOX	\$ 0.84
FUS:SFE14	1/4" X 1 1/16" GLASS FUSES..5 PER BOX	\$ 0.84
FUS:SFE20	1/4" X 1 1/4" GLASS FUSES..5 PER BOX	\$ 0.84
FUS:SFE30	1/4" X 1 7/16" GLASS FUSES..5 PER BOX	\$ 1.22

Littelfuse Ceramic Fuses

These torpedo shaped fuses are found on many European cars. They consist of a heat resistant body and a fuse element that stretches over the exterior of the body from end to end. The bodies vary in length and color to ensure proper replacement.

FUS:GBC5	CERAMIC FUSES..5 PER BOX	\$ 1.03
FUS:BP-GBC5	CERAMIC FUSES..5 PER BOX	\$ 1.00
FUS:GBC8	CERAMIC FUSES..5 PER BOX	\$ 1.08
FUS:BP-GBC15	CERAMIC FUSES..5 PER BOX	\$ 1.00
FUS:GBC16	CERAMIC FUSES..5 PER BOX	\$ 1.03
FUS:GBC25	CERAMIC FUSES..5 PER BOX	\$ 1.03
FUS:BP-GBC25	CERAMIC FUSES..5 PER BOX	\$ 1.00



FUSE HOLDERS

Littelfuse In-Line Fuse Holders

This in-line holder is for ATO style fuses from 1 to 20 amps. It has two 4" 16 gauge black wire leads.

FUS:FHA1	ATO IN-LINE FUSEHOLDER	\$ 13.74
FUS:094303	IN LINE ATO FUSE HOLDER DISPLAY..12 PER CARD	\$ 31.70

Other Brands

GROTE:82-2166	12 GA ATO FUSEHOLDER	\$ 4.26
GROTE:82-2165	12 GA CONTINUOUS LOOP ATO FUSEHOLDER	\$ 1.86
GROTE:82-2209	14 GA ATO FUSEHOLDER	\$ 2.12
GROTE:82-2207	16 GA ATO FUSEHOLDER	\$ 3.72

This in-line holder is for MAXI fuses up to 60 amps. It has two 6" 6 gauge black wire leads.

FUS:MAH1	MAXI IN-LINE FUSEHOLDER	\$ 10.81
----------	-------------------------	----------

Mini Fuse holder

GROTE:82-2208	14 GA MIN FUSEHOLDER	3.72
---------------	----------------------	------

This in-line holder is for AGC 30amp fuses. It has two 4" 12 gauge orange wire leads.

FUS:FNY30	UNIVERSAL GLASS IN LINE FUSE HOLDER	\$ 1.63
FUS:094292	IN LINE GLASS FUSE HOLDER DISPLAY..12 PER CARD	\$ 29.28

These kits allow you to add a circuit without cutting and splicing. They turn one fuse slot into two while providing protection for both.

FUS:FHA200BP	ATO ADD A CIRCUIT KIT	\$ 13.52
FUS:FHM200BP	MINI ADD A CIRCUIT KIT	\$ 13.52

CIRCUIT BREAKERS

Littelfuse Circuit Breakers

A circuit protection device that can be reset without replacement. Available in non-cycling design that requires shutting of the current before it can be reset or cycling design that will reset itself while the current is on. Available in ATO, MINI, MAXI, fuse clip type, and stud mount terminal designs.

The Universal Circuit Breaker is designed to mount in an ATO style fuse block. It has snap off terminals for greater flexibility. It is non-cycling.

FUS:UCB10	UNIVERSAL CIRCUIT BREAKER	\$ 3.37
FUS:UCB15	UNIVERSAL CIRCUIT BREAKER	\$ 3.37
FUS:UCB20	UNIVERSAL CIRCUIT BREAKER	\$ 5.91
FUS:UCB25	UNIVERSAL CIRCUIT BREAKER	\$ 3.37
FUS:UCB30	UNIVERSAL CIRCUIT BREAKER	\$ 5.91



MONDAY-FRIDAY
8am-5pm a helpful
HUMAN voice will
always answer the
phone
(770)474-1286





ELECTRICAL SUPPLIES

CIRCUIT BREAKERS



The Fuse Clip Circuit Breaker is designed for glass fuses without physical alterations in the system. It is non-cycling

FUS:CBF15	FUSE CLIP TYPE CIRCUIT BREAKER	\$ 2.56
FUS:CBF20	FUSE CLIP TYPE CIRCUIT BREAKER	\$ 2.56
FUS:CBF25	FUSE CLIP TYPE CIRCUIT BREAKER	\$ 2.56
FUS:CBF30	FUSE CLIP TYPE CIRCUIT BREAKER	\$ 2.56
FUS:CBF40	FUSE CLIP TYPE CIRCUIT BREAKER	\$ 2.56

These Specialty OEM circuit Breakers are designed to mount in an ATO style fuse block. They are cycling.

FUS:ACB20	OEM PLUG IN TYPE CIRCUIT BREAKER	\$ 3.52
FUS:ACB30	OEM PLUG IN TYPE CIRCUIT BREAKER	\$ 3.22
FUS:CCB25	OEM PLUG IN TYPE CIRCUIT BREAKER	\$ 4.96

These Stud Type Low Voltage Circuit Breaker are designed to be mounted in tough to reach places. It is cycling.

FUS:812005ST	LOW VOLT STUD CIRCUIT BREAKER	\$ 2.67
FUS:812010ST	LOW VOLT STUD CIRCUIT BREAKER	\$ 2.67
FUS:812015ST	LOW VOLT STUD CIRCUIT BREAKER	\$ 2.67
FUS:812020ST	LOW VOLT STUD CIRCUIT BREAKER	\$ 2.67
FUS:812025ST	LOW VOLT STUD CIRCUIT BREAKER	\$ 2.67
FUS:812030ST	LOW VOLT STUD CIRCUIT BREAKER	\$ 2.67
FUS:813010ST	LOW VOLT STUD CIRCUIT BREAKER	\$ 2.67
FUS:813015ST	LOW VOLT STUD CIRCUIT BREAKER	\$ 2.86
FUS:813030ST	LOW VOLT STUD CIRCUIT BREAKER	\$ 2.86
FUS:813040ST	LOW VOLT STUD CIRCUIT BREAKER	\$ 2.86

Other Brands

GROTE:82-2180	15 AMP UNIVERSAL CIRCUIT BREAKERS	\$ 3.00
GROTE:82-2181	20 AMP UNIVERSAL CIRCUIT BREAKERS	\$ 3.00
GROTE:82-2183	30 AMP UNIVERSAL CIRCUIT BREAKERS	\$ 3.05
GROTE:82-2195	10 AMP PLUG IN STYL UNIVERSAL CIRCUIT BREAKER	\$ 4.02
GROTE:82-2198	30 AMP PLUG IN STYL UNIVERSAL CIRCUIT BREAKER	\$ 4.02
GROTE:82-2199	25 AMP PLUG IN STYL UNIVERSAL CIRCUIT BREAKER	\$ 4.02

Littelfuse Battery Master Switch

This device allows you to disable the battery, leaving your vehicle safe and sound. It is ideal for cars in longer term storage or construction vehicles left unattended over night.

FUS:ATD200BP	DETACHABLE BATTERY MASTER SWITCH	\$ 1.59
--------------	----------------------------------	---------

FUSE ASSORTMENTS

Littelfuse Professional Fuse Caddy

This unit provides a complete assortment of fuses for the professional installer's on the road needs. It comes with 180 of the most popular fuses, 3 pullers and a tester. It has ATO, MINI, AGC, SFE, and MAXI style fuses.

FUS:094396	180 PIECE / 3 PULLER PROFESSIONAL FUSE CADDY	\$ 73.64
------------	--	----------

Littelfuse Heavy Duty Professional Shop Assortment

This 460 piece assortment provides a central location for all your fuse/circuit breaker/flasher needs. It comes in a rugged plastic case with section for each piece. It has ATO, AGA, AGC, AGU, AGX, SFE, PAL and MAXI style fuses, Universal and Stud Type Circuit Breakers, thermal and electronic flashers, and ATO and glass fuse holders.

FUS:094423	460 PIECE HEAVY DUTY SHOP ASSORTMENT	\$ 238.39
------------	--------------------------------------	-----------

Littelfuse Bulk Fuse Assortments

FUS:094298	100 PIECE GLASS FUSE ASSORTMENT	\$ 20.21
FUS:094375	20 PIECE PAL ASSORTMENT	\$ 42.58
FUS:094424	30 PIECE PAL ASSORTMENT	\$ 63.99
FUS:MRS1	120 PIECE ATO MODULAR ASSORTMENT	\$ 39.74
FUS:094410	160 PIECE ATO FUSE ASSORTMENT	\$ 63.79
FUS:094374	66 PIECE MINI / MAXI FUSE ASSORTMENT	\$ 44.24
FUS:MRS2	132 PIECE MINI / MAXI MODULAR ASSORTMENT	\$ 73.87
FUS:094461	8 PIECE M IN FUSE ASSORTMENT WITH TESTER/PULLER	\$ 10.23

Littelfuse Carded Assortments

FUS:094133	5 PIECE EUROPEAN CAR FUSE ASSORTMENT	\$ 1.16
FUS:094135	5 PIECE JAPANESE CAR FUSE ASSORTMENT	\$ 1.16
FUS:094154	5 PIECE AMERICAN CAR FUSE ASSORTMENT	\$ 1.16
FUS:094202	8 PIECE ATO FUSE ASSORTMENT	\$ 7.35
FUS:094363	8 PIECE M IN FUSE ASSORTMENT WITH PULLER	\$ 3.81
FUS:094400	40 PIECE ATO VALUE PACK WITH TESTER AND PULLER	\$ 19.34
FUS:094419	9 PIECE GLASS FUSE ASSORTMENT WITH PULLER	\$ 2.45

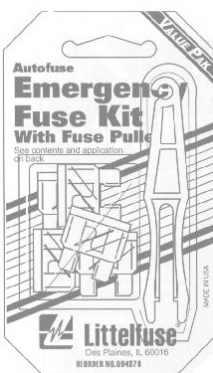

ELECTRICAL SUPPLIES



FUSE ASSORTMENTS

Littelfuse Fuse Master Displays

094262 has 20 ATO emergency kits Each kit contains 1 ATO3, ATO5, ATO7.5, ATO10, ATO15, ATO20, ATO25, and ATO30.

FUS:094262	ATO FUSE ASSORTMENT DISPLAY..20 / 8 PIECE BOXES	\$ 50.64
------------	---	----------

FDR240 contains 100 ATO, 60 MINI, 10 MAXI, and 70 glass fuses.

FUS:FDR240	240 PIECE FUSE DISPLAY ASSORTMENT	\$ 88.83
------------	-----------------------------------	----------

FDR340 contains 150 ATO, 60 MINI, 10 MAXI, and 120 glass fuses.

FUS:FDR340	340 PIECE FUSE DISPLAY ASSORTMENT	\$ 115.10
------------	-----------------------------------	-----------

FDR440 contains 190 ATO, 60 MINI, 10 MAXI, and 180 glass fuses.

FUS:FDR440	440 PIECE FUSE DISPLAY ASSORTMENT	\$ 139.02
------------	-----------------------------------	-----------

FDR004 is an empty display.

FUS:FDR004	EMPTY FUSE RACK..1EACH	\$ 10.94
------------	------------------------	----------

WIRE

Primary Wire

GROTE:10GA-100-BLK	10 GA BLACK PRIMARY WIRE...100'	\$ 38.03
GROTE:10GA-100-BLU	10 GA BLUE PRIMARY WIRE...100'	\$ 39.00
GROTE:10GA-100-GRN	10 GA GREENK PRIMARY WIRE...100'	\$ 39.00
GROTE:10GA-100-RED	10 GA RED PRIMARY WIRE...100'	\$ 38.03
GROTE:10GA-100-WHT	10 GA WHITE PRIMARY WIRE...100'	\$ 39.00
GROTE:10GA-100-YEL	10 GA YELLOW PRIMARY WIRE...100'	\$ 39.00
GROTE:12GA-100-BLK	12 GA BLACK PRIMARY WIRE...100'	\$ 25.62
GROTE:12GA-100-BLU	12 GA BLUE PRIMARY WIRE...100'	\$ 22.94
GROTE:12GA-100-BRN	12 GA BROWN PRIMARY WIRE...100'	\$ 23.99
GROTE:12GA-100-GRN	12 GA GREEN PRIMARY WIRE...100'	\$ 23.99
GROTE:12GA-100-ORG	12 GA ORANGE PRIMARY WIRE...100'	\$ 34.17
GROTE:12GA-100-RED	12 GA RED PRIMARY WIRE...100'	\$ 26.52
GROTE:12GA-100-WHT	12 GA WHITE PRIMARY WIRE...100'	\$ 26.52
GROTE:12GA-100-YEL	12 GA YELLOW PRIMARY WIRE...100'	\$ 23.99
GROTE:14GA-100-BLK	14 GA BLACK PRIMARY WIRE...100'	\$ 22.34
GROTE:14GA-100-BLU	14 GA BLUE PRIMARY WIRE...100'	\$ 14.31
GROTE:14GA-100-BRN	14 GA BROWN PRIMARY WIRE...100'	\$ 16.89
GROTE:14GA-100-GRN	14 GA GREEN PRIMARY WIRE...100'	\$ 16.89
GROTE:14GA-100-ORG	14 GA ORANGE PRIMARY WIRE...100'	\$ 16.04
GROTE:14GA-100-PUR	14 GA PURPLE PRIMARY WIRE...100'	\$ 14.31
GROTE:14GA-100-RED	14 GA RED PRIMARY WIRE...100'	\$ 16.03
GROTE:14GA-100-WHT	14 GA WHITE PRIMARY WIRE...100'	\$ 14.31
GROTE:14GA-100-YEL	11 GA BLACK PRIMARY WIRE...100'	\$ 16.03
GROTE:16GA-100-BLK	16 GA BLACK PRIMARY WIRE...100'	\$ 11.25
GROTE:16GA-100-BLU	16 GA BLUE PRIMARY WIRE...100'	\$ 11.85
GROTE:16GA-100-BRN	16 GA BROWN PRIMARY WIRE...100'	\$ 11.61
GROTE:16GA-100-GRN	16 GA GREEN PRIMARY WIRE...100'	\$ 11.61
GROTE:16GA-100-ORG	16 GA ORANGE PRIMARY WIRE...100'	\$ 13.20
GROTE:16GA-100-RED	16 GA RED PRIMARY WIRE...100'	\$ 11.85
GROTE:16GA-100-WHT	16 GA WHITE PRIMARY WIRE...100'	\$ 11.61
GROTE:16GA-100-YEL	16 GA YELLOW PRIMARY WIRE...100'	\$ 11.84
GROTE:18GA-100-BLK	18 GA BLACK PRIMARY WIRE...100'	\$ 9.06
GROTE:18GA-100-BLU	18 GA BLUE PRIMARY WIRE...100'	\$ 9.42
GROTE:18GA-100-BRN	18 GA BROWN PRIMARY WIRE...100'	\$ 10.31
GROTE:18GA-100-GRN	18 GA GREEN PRIMARY WIRE...100'	\$ 10.02
GROTE:18GA-100-ORG	18 GA ORANGE PRIMARY WIRE...100'	\$ 10.02
GROTE:18GA-100-PUR	18 GA PURPLE PRIMARY WIRE...100'	\$ 10.02
GROTE:18GA-100-RED	18 GA REDK PRIMARY WIRE...100'	\$ 10.31
GROTE:18GA-100-WHT	18 GA WHITE PRIMARY WIRE...100'	\$ 10.02
GROTE:18GA-100-YEL	18 GA YELLOW PRIM ARY WIRE...100'	\$ 9.06

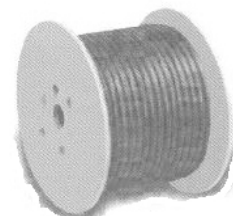
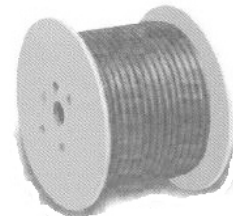



ELECTRICAL SUPPLIES

ELECTRICAL CONNECTORS AND TERMINALS

Terminals and Connectors

Heat shrink seamless butt connector.

GROTE:83-2150	22-18 HEAT SHRINK BUTT CONNECTOR...100 PER BOX	\$ 39.99
GROTE:83-2550	22-18 HEAT SHRINK BUTT CONNECTOR...50 PER BOX	\$ 32.64
GROTE:83-2350	16-14 HEAT SHRINK BUTT CONNECTOR...50 PER BOX	\$ 44.00

Nylon insulated seamless butt connectors

GROTE:83-2190	22-18 NYLON BUTT CONNECTOR...100 PER BOX	\$ 15.30
GROTE:83-2390	16-14 NYLON BUTT CONNECTOR...100 PER BOX	\$ 11.34

Nylon Bullet Connectors

GROTE:83-2227	16-14 NYLON MALE BULLET COONECTORS..50 PER BAG	\$ 13.50
GROTE:83-2402	16-14 NYLON INSULATED FEMALE BULLETT CONNECTOR ..50 PER BAG	\$ 13.20

Nylon Female quick Disconnect

GROTE:83-2388	16-14 NYLON FEMALE QUICK DISCONNECTS..50 PER BAG	\$ 8.18
GROTE:83-2225	12-10 NYLON FEMALE QUICK DISCONNECTS..50 PER BAG	\$ 9.90

Nylon Male quick Disconnect

GROTE:83-2399	16-14 NYLON MALE QUICK DISCONNECTS..50 PER BAG	\$ 7.32
---------------	--	---------

Nylon Insulated Female quick Disconnect

GROTE:83-3587	12-10 NYLON INSULATED FEMALE QUICK DISCONNECTS..50 PER BAG	\$ 10.24
---------------	--	----------

Nylon Ring Terminals

GROTE:83-2208	22-18 3/8 HOLE RING CONNECTOR..50 PER BOX	\$ 12.42
GROTE:83-2447	16-14 #10 HOLE RING CONNECTOR..50 PER BOX	\$ 10.56
GROTE:83-2448	16-14 1/4 HOLE RING CONNECTOR..50 PER BOX	\$ 10.92
GROTE:83-2213	16-14 5/16 HOLE RING CONNECTOR..50 PER BOX	\$ 13.20
GROTE:83-2449	16-14 3/8 HOLE RING CONNECTOR..50 PER BOX	\$ 11.40
GROTE:83-2455	12-10 #8 & #10 HOLE RING CONNECTOR..50 PER BOX	\$ 11.56
GROTE:83-2456	12-10 1/4 HOLE RING CONNECTOR..50 PER BOX	\$ 14.44
GROTE:83-2457	12-10 5/16 HOLE RING CONNECTOR..50 PER BOX	\$ 14.44
GROTE:83-2458	12-10 3/8 HOLE RING CONNECTOR..50 PER BOX	\$ 18.00

83-2150
83-2550
82-2350



83-2190
83-2390



83-2388
83-2225

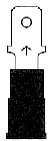

83-2399



23-3587

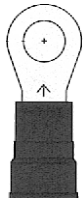

83-2208 / 83-2447
83-2448 / 83-2213
83-2449 / 83-2455
83-2456 / 83-2457
83-2458



83-2222

PARKER BROTHERS, INC.

Nylon Spade Terminal

GROTE:83-2222	12 - 10 #8 & #10 STUD SPADE CONNECTOR..50 PER BOX	\$ 13.32
---------------	---	----------

Quick Splice Connector - Self Stripping Tap Connectors

GROTE:83-2383	16-14 QUICK SPLICE CONNECTORS..25 PER BAG	\$ 3.96
---------------	---	---------

Quick Splice Connector - Self Stripping Special Adapters

GROTE:83-2904	16-14 FEMALE QUICK SPLICE CONNECTORS...100 PER BAG	\$ 16.11
---------------	--	----------

Don't See The Terminal
You Need
Ask Your Rep!!!
Parker Brothers Can Help!!

ELECTRICAL SUPPLIES



ELECTRICAL TERMINAL ASSORTMENTS

3M Terminal Assortment Kit

24 most popular insulated terminals in a metal box with dividers.

3M:06160 DELUXE TERMINAL ASSORTMENT KIT..1 KIT \$ 185.03

Carrand Terminal Assortment Kit

18 of the most popular insulated terminals and connectors in a plastic box with dividers.

CAR:W5213 160 PIECE PRO TERMINAL ASSORTMENT..1 EACH \$ 16.25

Butt Connectors With Heat Shrink Tubing Assortment

This assortment contains 8 red (18-22) vinyl, solderless butt connectors with heat shrink tubing, 8 blue (14-16) vinyl, solderless butt connectors with heat shrink tubing and 4 yellow (10-12) vinyl, solderless butt connectors with heat shrink tubing.

TMR:OPK201 BUTT CONNECTOR WITH HEAT SHRINK ASSORTMENT..20 PIECES / 3 SIZES \$ 9.35

Other Terminal Assortment

21 of the most popular vinyl and nylon butt connectors and disconnects in a plastic box with dividers.

TMR:OPK920 VINYL/NYLON BUTT CONNECTOR & DISCONNECT ASSORTMENT..276 PIECES/21 TERMINALS \$ 26.24

24 of the most popular solderless terminals in a plastic box with dividers.

TMR:OPK940 SOLDERLESS TERMINAL ASSORTMENT..940 PIECES / 30 TERMINALS \$ 60.74

18 of the most popular solderless terminals in a plastic box with dividers.

TMR:OPK960 SOLDERLESS TERMINAL ASSORTMENT..334 PIECES / 18 TERMINALS \$ 19.97



BATTERY SUPPLIES

Bulk Battery Cable

GROTE:82-5714	BLACK 4 GA BATTERY CABLE..25' PER ROLL	\$ 45.90
GROTE:82-6717	RED 4 GA BATTERY CABLE..25' PER ROLL	\$ 45.90

Battery Terminals

GROTE:84-9671	TOP POST BATTERY TERMINAL..10 PER CARD	\$ 8.10
GROTE:84-9672	SIDE POST BATTERY TERMINAL..10 PER CARD	\$ 8.10
GROTE:84-9047	1 GA STRAIGHT NEGATIVE TERMINAL..1 EACH	\$ 4.25
GROTE:84-9048	1 GA STRAIGHT POSITIVE TERMINAL..1 EACH	\$ 4.25
GROTE:84-9056	1/0 GA STRAIGHT NEGATIVE TERMINAL..1 EACH	\$ 4.38
GROTE:84-9057	1/0 GA STRAIGHT POSITIVE TERMINAL..1 EACH	\$ 4.37

Battery Lugs

GROTE:84-9515	4 GA 1/4 HOLE COPPER LUG..1 EACH	\$ 0.70
GROTE:84-9516	4 GA 5/16 HOLE COPPER LUG..1 EACH	\$ 0.70
GROTE:84-9430	4 GA 3/8 HOLE COPPER LUG..1 EACH	\$ 0.70
GROTE:84-9517	2 GA 1/4 HOLE COPPER LUG..1 EACH	\$ 0.90
GROTE:84-9518	2 GA 5/16 HOLE COPPER LUG..1 EACH	\$ 0.88
GROTE:84-9431	2 GA 3/8 HOLE COPPER LUG..1 EACH	\$ 0.90
GROTE:84-9531	1 GA 5/16 HOLE COPPER LUG..1 EACH	\$ 0.94
GROTE:84-9432	1 GA 3/8 HOLE COPPER LUG..1 EACH	\$ 0.95
GROTE:84-9532	1/0 GA 5/16 HOLE COPPER LUG..1 EACH	\$ 1.21
GROTE:84-9433	1/0 GA 3/8 HOLE COPPER LUG..1 EACH	\$ 1.21

Battery Holders

These units are designed to securely hold your vehicle's battery in place.

CAR:5-342 BATTERY HOLD DOWN..1 EACH \$ 3.00

Alligator Charging Clips

BAT:BK201	UNIVERSAL CHARGING CLIPS..1 PAIR	\$ 2.91
PRI:70306	INSULATED CHARGING CLIPS..2 PER PACK	\$ 1.61



Parker Brothers
gladly accepts
Visa, Mastercard
Discover &
American Express

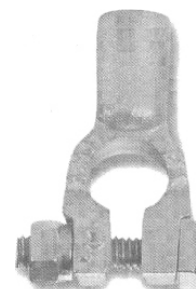



ELECTRICAL SUPPLIES

WIRE WEATHERPROOFING

Heat Shrink Tubing

GROTE:84-4015	22-18 WIRE 1/8 HEAT SHRINK..6/6" PIECES	\$ 5.52
GROTE:84-4016	20-12 WIRE 3/16 HEAT SHRINK..6/6" PIECES	\$ 7.08
GROTE:84-4017	16-10 WIRE 1/4 HEAT SHRINK..6/6" PIECES	\$ 7.50
GROTE:84-4018	12-8 WIRE 3/8 HEAT SHRINK..6/6" PIECES	\$ 8.70
GROTE:84-4019	8-4 WIRE 1/2 HEAT SHRINK..6/6" PIECES	\$ 9.90

Heat Shrink Tubing Assortments

This assortment contains 3" strips of dual wall heat shrink tubing. It has 8 black pieces of 1/2" 10 red pieces of 1/8" and 10 blue pieces of 1/4".

TMR:OPK57	DUAL WALL HEAT SHRINK ASSORTMENT..28 PIECES / 3 SIZES	\$ 11.93
-----------	---	----------

This assortment contains 3" strips of dual and single wall heat shrink tubing. It has 10 red, single wall pieces of 1/8" 10 blue, single wall pieces of 1/4", 5 yellow, single wall pieces of 5/16", 5 black, single wall pieces of 1/2", 5 black, dual wall pieces of 1/2", 10 red, dual wall pieces of 1/8" and 10 blue, dual wall pieces of 1/4".

TMR:OPK60	SINGLE & DUAL WALL HEAT SHRINK ASSORTMENT..55 PIECES / 7 SIZES	\$ 18.73
-----------	--	----------

3M Electrical Tape

3M :06132	3/4" X 66" SUPER 33 ELECTRICAL TAPE..1 ROLL	\$ 4.86
3M :06133	3/4" X 52" SUPER 33 ELECTRICAL TAPE..1 ROLL	\$ 4.19
3M :06143	3/4" X 66" SUPER 88 ELECTRICAL TAPE..1 ROLL	\$ 5.49
3M :49656	3/4" X 60" TARTAN ELECTRICAL TAPE..1 ROLL	\$ 0.96
3M :06165	3/4" X 15" SPLICING COMPOUND..1 ROLL	\$ 5.30

Other Brands

TAP :20122	3/4" X 60' ELECTRICAL TAPE	\$ 0.70
NAC :NA58	RED BRUSH ON ELECTRICAL TAPE..4 OZ CAN	\$ 3.51
NAC :NA55	BLACK BRUSH ON ELECTRICAL TAPE..4 OZ CAN	\$ 3.51

3M Scotch Electrical Moisture Sealant

This quick and easy method of moisture-proofing electrical connections protects against vibrations, road grime, and abrasions.

3M :06149	2 1/2" X 2 1/2" ELECTRICAL MOISTURE SEAL PATCH..25 PER BOX	\$ 11.61
-----------	--	----------

WIRE MANAGEMENT

Cable Ties

W/T:4IN-B	4" BLACK WIRE TIES..100 PER BAG	\$ 2.01
W/T:7IN-B	7" BLACK WIRE TIES..100 PER BAG	\$ 3.45
W/T:7IN-N	7" NATURAL WIRE TIES..100 PER BAG	\$ 3.42
W/T:8IN-B	8" BLACK WIRE TIES..100 PER BAG	\$ 2.18
W/T:8IN-BLU	8" BLUE WIRE TIE..100 PER BAG	\$ 6.75
W/T:8IN-GRN	8" GREEN WIRE TIES..100 PER BAG	\$ 6.75
W/T:8IN-ORG	8" ORANGE WIRE TIE..100 PER BAG	\$ 6.75
W/T:8IN-RED	8" RED WIRE TIES..100 PER BAG	\$ 6.75
W/T:8IN-YEL	8" YELLOW WIRE TIES..100 PER BAG	\$ 6.75
W/T:8IN-BRN	8" BROWN WIRE TIE..100 PER BAG	\$ 6.75
W/T:8IN-GRY	8" GREY WIRE TIES..100 PER BAG	\$ 6.75
W/T:8IN-PUR	8" PURPLE WIRE TIE..100 PER BAG	\$ 6.75
W/T:11IN-B	11" BLACK WIRE TIES..100 PER BAG	\$ 6.93
W/T:11IN-N	11" NATURAL WIRE TIES..100 PER BAG	\$ 6.58
W/T:14IN-B	14" BLACK WIRE TIES..100 PER BAG	\$ 8.21
W/T:14IN-N	14" NATURAL WIRE TIES..100 PER BAG	\$ 9.99
W/T:14IN-B-HD	14" HEAVY DUTY BLACK WIRE TIES..100 PER BAG	\$ 16.08
W/T:14IN-N-HD	14" HEAVY DUTY NATURAL WIRE TIES..100 PER BAG	\$ 11.98
W/T:24IN-B	24" BLACK WIRE TIES..100 PER BAG	\$ 17.02
W/T:36IN-B	36" BLACK WIRE TIES..50 PER BAG	\$ 17.10
W/T:48IN-G	48" 175LB GRAY WIRE TIE..50 PER BAG	\$ 26.58
GROTE:85-6030	RED 7.5" WIRE TIES..50 PER BAG	\$ 1.92
GROTE:85-6031	ORANGE 7.5" WIRE TIES..50 PER BAG	\$ 1.92
GROTE:85-6032	BLUE 7.5" WIRE TIES..50 PER BAG	\$ 1.92
GROTE:85-6033	YELLOW 7.5" WIRE TIES..50 PER BAG	\$ 1.92
GROTE:85-6034	GREEN 7.5" WIRE TIES..50 PER BAG	\$ 1.92
GROTE:85-6035	PURPLE 7.5" WIRE TIES..50 PER BAG	\$ 1.92
GROTE:85-6036	GRAY 7.5" WIRE TIES..50 PER BAG	\$ 1.92

Wire Tie Assortments

PIC:300-8000	CABLE TIE ASSORTMENT..250 TIES & A DISPLAY PACK	\$ 21.21
--------------	---	----------

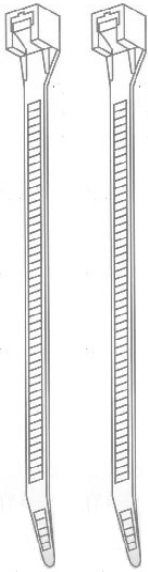

ELECTRICAL SUPPLIES



WIRE MARKERS

3M ScotchCode Wire Marker Tape

This non-smear film tape allows for easy identification of ignition wires. Their acrylic adhesive system results in superior oil/solvent resistance.

3M :09368	NUMBERED WIRE MARKER TAPE..#'S 0-9..10 ROLL CASE	\$ 20.32
3M :09370	NUMBERED WIRE MARKER TAPE..# 1..10 ROLL BOX	\$ 19.84
3M :09373	NUMBERED WIRE MARKER TAPE..# 4..10 ROLL BOX	\$ 19.84
3M :09375	NUMBERED WIRE MARKER TAPE..# 6..10 ROLL BOX	\$ 19.84
3M :09376	NUMBERED WIRE MARKER TAPE..# 7..10 ROLL BOX	\$ 19.84
3M :09377	NUMBERED WIRE MARKER TAPE..# 8..10 ROLL BOX	\$ 19.84
3M :09378	NUMBERED WIRE MARKER TAPE..# 9..10 ROLL BOX	\$ 19.84
3M :12174	WIRE MARKER DISPENSER..1 EACH	\$ 31.88

MONDAY-FRIDAY
8am-5pm a helpful
HUMAN voice will
always answer the
phone
(770)474-1286

FOR 50+ YEARS,
PARKER
BROTHERS
HAS BEEN
SERVING ATLANTA.
**THANK YOU FOR
YOUR CONTINUED
SUPPORT!!**

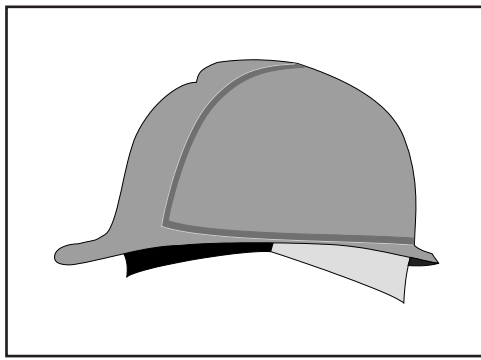

SAFETY SUPPLIES

ABSORBENTS
GLOVES
EYE PROTECTION
BOOTS
RAIN GEAR
BACK BRACES
COVERALLS
DUST MASK
EAR PLUGS
APRONS AND VESTS
KNEE PADS
HAIRNETS
HARD HATS
BUILDING SAFETY
TRAFFIC SAFETY
GATORADE

SAFETY SUPPLIES



ABSORBENTS

Clay Absorbents

This granular absorbent soaks up all traces of oil and grease, reducing injuries. It will help provide traction while absorbing spills.

DRY:OIL-DRY	OIL ABSORBENT..40 LB	\$ 8.44
The super concentrated formula uses only 1/3 as much as regular oil dry to clean up the same amount of liquid.		
DRY:05000	CONCENTRATED ABSORBENT..20 LB	\$ 13.34
DRY:05025	QUICK SORB..25 LB	\$ 8.46



Nature's Broom Oil Absorbent

Nature's Broom is a **REVOLUTIONARY** absorbent technology that starts to soak up spills as soon as it touches the liquid. Independent tests have shown Nature's Broom to be over 4 1/2 times more absorbent than clay, which results in a smaller amount of Nature's Broom needed to clean up spills! Nature's Broom is lighter and less dense, which means you will get more product to use from a 40 lb. bag of Nature's Broom than you would from a 40 lb. bag of clay.

DRY:100-4	4LB BAG NATURE'S BROOM..1BAG	\$ 5.95
DRY:101-40	40LB BAG NATURE'S BROOM..1BAG	\$ 10.95



Berryman Green Stuff Absorbent

This absorbent quickly soaks up 15 times its own weight. It also will not leach. Its compact size makes it ideal for service trucks and emergency vehicles.

BER:7800	GREEN STUFF ABSORBENT..1LB	\$ 8.10
----------	----------------------------	---------

Absorbent Pads, Rugs, And Socks

These durable pads quickly absorb non-aggressive spills in high traffic areas. Dimples build in strength and allow fluid to spread through the material quicker for your best absorption

DRY:OIL-PAD-GRAY	15"X19" GRAY UNIVERSAL PADS..100 PER BUNDLE	\$ 55.08
DRY:OIL-PAD-GREEN	GREEN UNIVERSAL PADS..100 PER BUNDLE	\$ 49.95
DRY:GPB200S	15"X19" GRAY UNIVERSAL BONDED ABSORBENT PAD..200 PER BUNDLE	\$ 68.17

This rug is designed to help prevent messes before they happen. The poly backing prevents spilled liquids for leaking through and reduces rug movement.

DRY:OIL-RUG	36" X 100' POLY BACKED RUG..PBR-100	\$ 225.00
DRY:NPR150H	36"X150' BLACK UNIVERSAL INDUSTRIAL RUG	\$ 199.21

These socks are designed to keep work areas safe and clean. When put around the base of a leaking machine, they stop non-aggressive fluids from spreading across the floor

DRY:OIL-SOCK	3" X 4' ABSORBENT SOCK..30 PER CASE	\$ 71.56
--------------	-------------------------------------	----------

These high absorbency rolls can be crumpled, stuffed or wrapped around any problem leak area. They are durable enough for everyday use. The roll is perforated into 19" x 17" squares...so you only use what you need!!

DRY:GRA150H	30"X 150' HEAVY WEIGHT UNIVERSAL ROLL	\$ 92.57
DRY:GNRF150H	30"X150' GREEN HEAVY WEIGHT UNIVERSAL ABSORBENT ROLL	\$ 131.76
DRY:GRB144M	38" X 144' MEDIUM WEIGHT UNIVERSAL ROLL	\$ 99.00
DRY:GRF150H	38" X 144' MEDIUM WEIGHT UNIVERSAL ROLL	\$ 113.25

Oil drum drip pans are designed to keep your work area clean and safe by taking care of the annoying run-off many spouts allow.

DRY:DRIP-PAN	UNIVERSAL DRIP PAN..12 PER CASE	\$ 88.45
--------------	---------------------------------	----------

Oil Only Absorbents

These pads are a good replacement for clay absorbents where petroleum products are the primary problem and dust is a factor.

DRY:OIL-PAD-WHITE	15"X19" WHITE OIL ONLY PADS..100 PER BUNDLE	\$ 51.40
DRY:WPB200S	15"X19" BONDED WHITE OIL ONLY PADS..200 PER BUNDLE	\$ 46.59

This is the way to go if you are on a tight budget. This roll is ideal in low traffic areas, under leaky hoses, and around leaky equipment.

DRY:OIL-ROLL	38"X144' WHITE OIL ONLY HEAVY WEIGHT ROLL	\$ 97.09
--------------	---	----------

These products are excellent for skimming oil off water. They are ideal for boats, bilge areas, machine sump, and drainage areas.

DRY:OIL-BOOM	5" X 10' OIL ABSORBENT BOOM..4 PER BUNDLE	\$ 103.49
DRY:90858	18"X24" ABSORBENT PILLOWS..10 PER CASE	\$ 67.65

Oil drum drip pans and drum top pads are designed to keep work areas clean by taking care of annoying run on from pumps and spouts.

DRY:ODP24	OIL DRIP PAN..12 PER CASE	\$ 93.63
DRY:L90612	ABSORBENT PILLOWS WITH PANS..24 PILLOWS / 12 PANS	\$ 71.78
DRY:DRUM-PAD	DRUM TOP ABSORBENT PAD..25 PER BOX	\$ 70.22



Parker Brothers
gladly accepts
Visa, Mastercard
Discover &
American Express

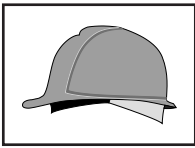

SAFETY SUPPLIES

ABSORBENTS

Spill Kits

An absolute must for any vehicle carrying oil or other dangerous materials. Parker Brothers can have personalized spill kits made to suit your particular needs.

DRY:90894	20 GAL HAZARDS MATERIALS SPILL KIT	\$ 140.94
DRY:90942	20 GAL OIL ONLY SPILL KIT	\$ 136.15
DRY:SMART-PAK	8 GAL UNIVERSAL SPILL KIT	\$ 51.43
DRY:SPKU-20	20 GAL UNIVERSAL SPILL KIT	\$ 120.25
DRY:SPKO95	95 GAL OIL ONLY SPILL KIT	\$ 508.04



GLOVES

Mechanic Gloves

G/J:1431	MEDIUM HITACTILE GLOVE..1 PAIR	\$ 5.51
G/J:1432	LARGE HITACTILE GLOVE..1 PAIR	\$ 5.87
G/J:1433	X LARGE HITACTILE GLOVE..1 PAIR	\$ 5.87

Latex Gloves

These powdered gloves are excellent for mechanics who want to keep their hands clean.

GLO:69-210-S	LIGHTLY POWDERED LATEX GLOVES..100 PER BOX	\$ 12.61
GLO:69-210-M	LIGHTLY POWDERED LATEX GLOVES..100 PER BOX	\$ 12.61
GLO:69-210-L	LIGHTLY POWDERED LATEX GLOVES..100 PER BOX	\$ 12.61
GLO:69-210-XL	LIGHTLY POWDERED LATEX GLOVES..100 PER BOX	\$ 12.61
GLO:69-318-M	POWDER FREE LATEX GLOVES..100 PER BOX	\$ 7.25
GLO:69-318-L	POWDER FREE LATEX GLOVES..100 PER BOX	\$ 7.25
GLO:69-318-XL	POWDER FREE LATEX GLOVES..100 PER BOX	\$ 11.78
GLO:SG375-M	MICRO FLEX SAFE GRIP GLOVES..50 PER BOX	\$ 15.93
GLO:SG375-L	MICRO FLEX SAFE GRIP GLOVES..50 PER BOX	\$ 16.88
GLO:SG375-XL	MICRO FLEX SAFE GRIP GLOVES..50 PER BOX	\$ 16.69
GLO:MF300-M	DIAMOND GRIP GLOVES..100 PER BOX..	\$ 15.75
GLO:MF300-L	DIAMOND GRIP GLOVES..100 PER BOX..	\$ 14.24
GLO:MF300-XL	DIAMOND GRIP GLOVES..100 PER BOX..	\$ 14.24



Nitrile Gloves

These gloves are for the mechanic whose hands are exposed to solvents. They are the heavy duty cousin to latex gloves.

GLO:92-600-M	GREEN POWDER FREE NITRILE GLOVES..100 PER BOX	\$ 13.58
GLO:92-600-L	GREEN POWDER FREE NITRILE GLOVES..100 PER BOX	\$ 13.58
GLO:92-600-XL	GREEN POWDER FREE NITRILE GLOVES..100 PER BOX	\$ 15.03
GLO:92-675-L	BLUE POWDER FREE NITRILE GLOVES..100 PER BOX	\$ 15.50
GLO:92-675-S	BLUE POWDER FREE NITRILE GLOVES..100 PER BOX	\$ 9.90
GLO:92-675-M	BLUE POWDER FREE NITRILE GLOVES..100 PER BOX	\$ 9.90
GLO:92-675-XL	BLUE POWDER FREE NITRILE GLOVES..100 PER BOX	\$ 9.90
ABC:BC-L	5MIL BLACK CAT NITRILE GLOVES..100 PER BOX	\$ 11.23
ABC:BC-M	5MIL BLACK CAT NITRILE GLOVES..100 PER BOX	\$ 10.89
ABC:BC-S	5MIL BLACK CAT NITRILE GLOVES..100 PER BOX	\$ 10.89
ABC:BC-XL	5MIL BLACK CAT NITRILE GLOVES..100 PER BOX	\$ 10.89
ABC:BC-2XL	BLACK CAT NITRILE 5 MIL GLOVES 2XL 100 PER BOX	\$ 11.63



Vinyl Gloves

These gloves are the light duty cousin to latex gloves.

GLO:34-715-S	LIGHTLY POWDERED VINYL GLOVES..100 PER BOX	\$ 5.12
GLO:34-715-M	LIGHTLY POWDERED VINYL GLOVES..100 PER BOX	\$ 5.12
GLO:34-715-L	LIGHTLY POWDERED VINYL GLOVES..100 PER BOX	\$ 5.12
GLO:34-715-XL	LIGHTLY POWDERED VINYL GLOVES..100 PER BOX	\$ 5.12



Work Gloves

GLO:ASA084	X-LARGE PIGSKIN DRIVERS GLOVES..1 PAIR	\$ 5.31
GLO:BROWN-JERSEY	BROWN JERSEY GLOVES..1 PAIR	\$ 0.89
GLO:7272	12" WELDING GLOVE..1 PAIR	\$ 4.20
GLO:LIB041	LARGE BLACK DIPPED GLOVES..1PAIR	\$ 1.99
GLO:WES005	BLUE DIPPED GLOVES..1 PAIR	\$ 1.10
GLO:F18LX	FLOCK LINED YELLOW LATEX GLOVES..12 PER PACK	\$ 12.32
GLO:ASA072	ECONOMY LEATHER PALM GLOVES..1PAIR	\$ 1.26
GLO:ASA158-XL	X-LARGE LEATHER PALM GLOVES..1PAIR	\$ 2.78
GLO:8050	LEATHER PALM GLOVES..1 PAIR	\$ 2.15
GLO:ASA005	INSULATED ORANGE PVC GLOVES..1 PAIR	\$ 4.69

SAFETY SUPPLIES



GLOVES

Work Gloves

GLO:ASA014	10" BLACK ROUGH GRIP PVC GLOVES..1 PAIR	\$ 2.26
GLO:ASA083	LARGE PIGSKIN DRIVERS GLOVES..1 PAIR	\$ 5.35
GLO:ASA004	WHITE KNIT BLUE DOT GLOVES..1 PAIR	\$ 1.00
GLO:8070	DOUBLE PALM LEATHER GLOVES..1 PAIR	\$ 2.99
GLO:ASA057-L	LARGE BRONCO LEATHER WORK GLOVES..1 PAIR	\$ 2.55



EYE PROTECTION

Safety Glasses

SAF:AAL072	Z-TEK SAFETY GLASS - BLUE LENS	\$ 2.18
SAF:AAL074	Z-TEK SAFETY GLASS - CLEAR LENS	\$ 2.09
SAF:AAL077	SAF BLUE SAFETY GLASSES - CLEAR LENS	\$ 1.75
SAF:AAL090	SAF BLACK SAFETY GLASSES - CLEAR LENS	\$ 3.65
SAF:AAL100	SAF BLACK SAFETY GLASSES - GRAY LENS	\$ 4.42
SAF:AAL122	PYRAMEX SAFETY GLASSES - CLEAR LENS	\$ 1.99
SAF:AAL123	PYRAMEX SAFETY GLASSES - GREY LENS	\$ 2.27
SAF:AAL131	1.5X READER SAFETY GLASSES	\$ 6.69
SAF:AAL132	2.0X READER SAFETY GLASSES	\$ 6.69
SAF:AAL133	2.5X READER SAFETY GLASSES	\$ 7.40
SAF:VIRTUA-V4-CLEAR	VIRTUA V4 SAFETY GLASSES - CLEAR LENS	\$ 3.60
SAF:VIRTUA-V4-TINTED	VIRTUA V4 SAFETY GLASSES - TINTED LENS	\$ 3.78



Eye wash Station

SAF:EYE-W-STATION	EYE WASH STATION..2 / 16 OZ BOTTLES OF SOLUTION..1 STATION	\$ 37.26
SAF:EYE-WASH	EYE WASH SOLUTION..16 OZ BOTTLE	\$ 9.56

Lens Cleaning Station

SAF:ASA1001	LARGE DISPOSABLE LENS CLEANING STATION..1 EACH	\$ 10.08
-------------	--	----------

BOOTS

Steel Toed Boots

SAF:PVC-BOOT-6	16" SIZE 6 BLACK STEEL TOE BOOTS..1 PAIR	\$ 18.95
SAF:PVC-BOOT-7	16" SIZE 7 BLACK STEEL TOE BOOTS..1 PAIR	\$ 18.95
SAF:PVC-BOOT-8	16" SIZE 8 BLACK STEEL TOE BOOTS..1 PAIR	\$ 18.95
SAF:PVC-BOOT-9	16" SIZE 9 BLACK STEEL TOE BOOTS..1 PAIR	\$ 18.04
SAF:PVC-BOOT-10	16" SIZE 10 BLACK STEEL TOE BOOTS..1 PAIR	\$ 18.95
SAF:PVC-BOOT-11	16" SIZE 11 BLACK STEEL TOE BOOTS..1 PAIR	\$ 18.95
SAF:PVC-BOOT-12	16" SIZE 12 BLACK STEEL TOE BOOTS..1 PAIR	\$ 18.95
SAF:PVC-BOOT-13	16" SIZE 13 BLACK STEEL TOE BOOTS..1 PAIR	\$ 18.95
SAF:PVC-BOOT-14	16" SIZE 14 BLACK STEEL TOE BOOTS..1 PAIR	\$ 18.95

FOR 50+ YEARS,
PARKER
BROTHERS
HAS BEEN
SERVING ATLANTA.
THANK YOU FOR
YOUR CONTINUED
SUPPORT!!



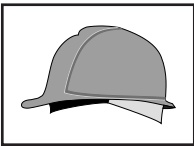

SAFETY SUPPLIES

RAIN GEAR

3Pc Rain Suits

SAF:65-300-L	3 PIECE RAIN SUIT..1 EACH	\$ 12.85
SAF:65-300-M	3 PIECE RAIN SUIT..1 EACH	\$ 12.85
SAF:65-300-S	3 PIECE RAIN SUIT..1 EACH	\$ 12.85
SAF:65-300-XL	3 PIECE RAIN SUIT..1 EACH	\$ 12.85
SAF:65-300-XXL	3 PIECE RAIN SUIT..1 EACH	\$ 13.50
SAF:65-300-XXXL	3 PIECE RAIN SUIT..1 EACH	\$ 11.22
SAF:65-300-XXXXL	3 PIECE RAIN SUIT..1 EACH	\$ 12.14
SAF:65-300-XXXXXL	3 PIECE RAIN SUIT..1 EACH	\$ 15.85



Rain Coats

SAF:RCR009	LARGE RAIN COAT..1 EACH	\$ 11.03
SAF:RCR012	X-LARGE RAIN COAT..1 EACH	\$ 11.03
SAF:RCR013	2X-LARGE RAIN COAT..1 EACH	\$ 12.75
SAF:RCR028	3X-LARGE RAIN COAT..1 EACH	\$ 11.74
SAF:RCR025	4X-LARGE RAIN COAT..1 EACH	\$ 17.25

BACK BRACES

Supportive Back Braces

Save your back when doing heavy lifting or manual labor, use a supportive back brace.

SAF:ASA090	SMALL BACK SUPPORT..1 EACH	\$ 15.26
SAF:ASA091	MEDIUM BACK SUPPORT..1 EACH	\$ 15.26
SAF:ASA092	LARGE BACK SUPPORT..1 EACH	\$ 15.26
SAF:ASA093	X-LARGE BACK SUPPORT..1 EACH	\$ 15.26
SAF:ASA094	2X-LARGE BACK SUPPORT..1 EACH	\$ 15.26
SAF:ASA095	3X-LARGE BACK SUPPORT..1 EACH	\$ 15.26
SAF:ASA096	4X-LARGE BACK SUPPORT..1 EACH	\$ 23.10
SAF:ASA097	5X-LARGE BACK SUPPORT..1 EACH	\$ 27.00



COVERALLS

Tyvek Coveralls

SAF:COVERALL-L	LARGE WHITE TYVEK COVERALL..25 PER CASE	\$ 111.35
SAF:COVERALL-2X	2X WHITE TYVEK COVERALL..25 PER CASE	\$ 118.18
SAF:COVERALL-3X	3X WHITE TYVEK COVERALL..25 PER CASE	\$ 126.15
SAF:COVERALL-4X	4X WHITE TYVEK COVERALL..25 PER CASE	\$ 131.95
SAF:COVERALL-5X	5X WHITE TYVEK COVERALL..25 PER CASE	\$ 139.93
SAF:COVERALL-6X	6X WHITE TYVEK COVERALL..25 PER CASE	\$ 158.05

DUST MASK

3M Maintenance Free Organic Vapor Half Facepiece Respirator Assembly P95

Half facepiece respirators may be used up to 10 OSHA PEL or applicable government standard, whatever is lower. Recommended for spray painting enamel, lacquer and pesticides.

3M :07193	LARGE DISPOSABLE 1/2 FACE RESPIRATOR..1 EACH	\$ 14.25
3M :07194	P95 FILTER FOR 07193 RESPIRATOR..10 PER BOX	\$ 21.28

Dust Mask

3M :07048	PARTICULATE RESPIRATOR..20 PER BOX	\$ 20.61
3M :07185	PARTICULATE RESPIRATOR WITH VALVE..10 PER BOX	\$ 22.22
3M :07192	MEDIUM DISPOSABLE 1/2 RESPIRATOR..1 EACH	\$ 17.84
3M :08184	DUST WELD RESPIRATOR..1 EACH	\$ 28.50



PARKER, BROTHERS, INC.

SAFETY SUPPLIES



EAR PLUGS

Ear Plugs

SAF:HSL009	UNCORDED LOW PRESSURE EAR PLUGS..100 PAIR PER BOX	\$ 26.74
SAF:HSL010	CORDED LOW PRESSURE EAR PLUGS..100 PAIR PER BOX	\$ 26.49

Sound Proof Ear Muffs

SAF:MSA004	SOUND CONTROL EAR MUFF..1 EACH	\$ 5.89
------------	--------------------------------	---------

APRONS AND VESTS

Protective Aprons

Protect yourself and your clothes, wear protective aprons when you work with harsh chemicals.

SAF:GREEN-APRON	GREEN PVC APRON..1 EACH	\$ 7.22
-----------------	-------------------------	---------

High Visibility Safety Vest

Worn by roadside crews, railway workers, airport terminal employees, etc. These vest insures you are seen.

SAF:V-ST	ORANGE VEST WITH REFLECTIVE STRIPE..1 EACH	\$ 6.80
SAF:LIME-VEST-L	LARGE LIME SAFETY VEST..1 EACH	\$ 15.50
SAF:LIME-VEST-XL	X-LARGE LIME SAFETY VEST..1 EACH	\$ 17.30
SAF:LIME-VEST-XXL	2X-LARGE LIME SAFETY VEST..1 EACH	\$ 15.50
SAF:LIME-VEST-XXXL	3X-LARGE LIME SAFETY VEST..1 EACH	\$ 15.50

KNEE PADS

Knee Pads

SAF:ASA088	KNEE PADS..1 PAIR	\$ 10.69
------------	-------------------	----------

HAIR NETS

Hair Nets

SAF:77-3500	WHITE HAIR NETS..100 PER BOX	\$ 26.35
SAF:1818	BLUE HAIR NETS..100 PER BOX	\$ 28.02

HARD HATS

Hard Hats

SAF:HARDHAT-B	BLUE HARD HAT..1 EACH	\$ 5.99
SAF:AAL042	ADJUSTABLE SIZE WHITE HARD HAT..1 EACH	\$ 10.08
SAF:HARDHAT-W	WHITE HARD HAT..1 EACH	\$ 7.99

Hard Hats Liner

SAF:AAL001	WINTER HARD HAT LINER..1 EACH	\$ 3.63
------------	-------------------------------	---------

BUILDING SAFETY

First Aid Kits

SAF:2025E	25 PERSON FIRST AID KIT..1 EACH	\$ 22.85
SAF:FIRST-AID	BULK FIRST AID KIT..1 EACH	\$ 89.90
SAF:6410	10 PERSON FIRST AID KIT W/EYE WASH STATION	\$ 14.93

Fire Extinguisher

SAF:P275	2 3/4 LB BC FIRE EXTINGUISHER..1 EACH	\$ 27.80
SAF:KIDDE360	5 LB ABC FIRE EXTINGUISHER..1 EACH	\$ 63.35

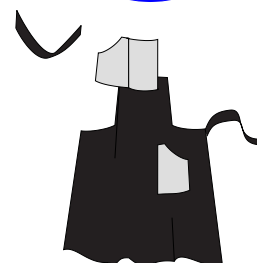

MONDAY-FRIDAY
8am-5pm a helpful
HUMAN voice will
always answer the
phone
(770)474-1286

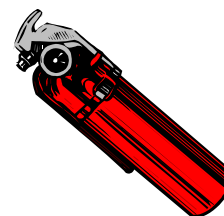

SAFETY SUPPLIES

BUILDING SAFETY

Barrier/Safety Tape

This black and yellow tape alerts people to dangerous areas.

TAP:172	2" X 36 YD BLACK AND YELLOW SAFETY TAPE	\$ 12.01
---------	---	----------

3M Surfacing Tapes

These surfacing tapes make slick and dangerous areas safe by adding traction. It is great on stairs, steep inclines, or step rails.

3M :19223	4" X 60" BLACK SAFETY WALK TAPE..1 ROLL	\$ 96.48
3M :19245	4" X 60" CLEAR SAFETY WALK TAPE..1 ROLL	\$ 62.45
3M :19281	4" X 60" BLACK CONFORMABLE SAFETY WALK TAPE..1 ROLL	\$ 124.67
3M :19282	6" X 60" BLACK CONFORMABLE SAFETY WALK TAPE..1 ROLL	\$ 186.96

Other Brands

TAP:ANTI SKID	1/2" ANTI SKID SAFETY TAPE	\$ 115.50
---------------	----------------------------	-----------

Oily Waste Cans

Oily waste cans are essential whenever solvent clothes and wiping rags are used. The can remains closed when not in use. When operated by hand or foot, the pail opens and closes automatically when released. Its round shape and raised bottom increase air flow around the cans and greatly reduce the risk of combustion.

G/C:9-100	6 GAL OILY WASTE CAN..1 EACH	\$ 73.98
G/C:9-300	10 GAL OILY WASTE CAN..1 EACH	\$ 87.28
G/C:9-500	14 GAL OILY WASTE CAN..1 EACH	\$ 77.90

TRAFFIC SAFETY

Cones

SAF:12-IN-CONE	12" ORANGE SAFETY CONE..1 EACH	\$ 6.59
SAF:18-IN-CONE	18" ORANGE SAFETY CONE..1 EACH	\$ 8.99
SAF:28-IN-CONE	28" ORANGE SAFETY CONE..1 EACH	\$ 13.29
SAF:36"-CONE	36" ORANGE SAFETY CONE..1 EACH	\$ 21.50

Flags and Triangles

SAF:GLO-FLAG	13 X 13 TRAFFIC FLAG..1 EACH	\$ 4.60
SAF:99ET	EMERGENCY TRIANGLE KIT..3 TRIANGLES PER KIT	\$ 16.72

GATORADE

Gatorade

Protect yourself from dehydration. Drink plenty of fluids

SAF:GATOR-VPK	GATORADE VARIETY PACK..32 / 21 OZ POWDERED PACKS	\$ 152.89
---------------	--	-----------

FOR 50+ YEARS,
PARKER BROTHERS
HAS BEEN
SERVING ATLANTA.
THANK YOU
FOR YOUR CONTINUED
SUPPORT!!



Parker Brothers
gladly accepts
Visa, Mastercard
Discover &
American Express

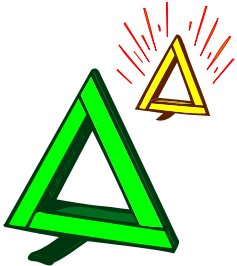



HARDWARE

FASTENERS
FASTENER ASSORTMENTS
PAINT BRUSHES
SPRAY PRIMER
SPRAY PAINT
CAULK
LIGHTING
BATTERIES
TRAILER ACCESSORIES
STRAPS AND TARPS
DRILL BITS
SHOVELS AND SCRAPERS
PACKAGING MATERIALS
SPRAYERS
WEED KILLER AND INSECT REPELLENT
MISCELLANEOUS PRODUCTS
SERVICE STATION HARDWARE

PARKER BROTHERS, INC.

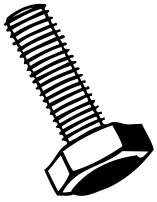

Mystik
The Ultimate
In Fine
Lubrication

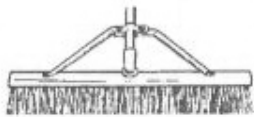
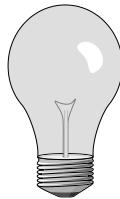

NATIONAL-SPENCER, INC.



Permatex



HARDWARE



FASTENERS

Pik-a-Nut Hex Head Cap Bolts

These grade 5 bolts are zinc plated medium carbon steel. They resist rust and corrosion.

ALL SIZES FASTNERS \$ 3.37

STANDARD

1/4USS (20)

PIC 102-0404 (1/2")	34
PIC 102-0406 (3/4")	30
PIC 102-0408 (1")	26
PIC 102-0410 (1 1/4")	23
PIC 102-0412 (1 1/2")	20
PIC 102-0414 (1 3/4")	18
PIC 102-0416 (2")	16
PIC 102-0420 (2 1/2")	12
PIC 102-0424 (3")	9

1/4SAE (28)

PIC 101-0404 (1/2")	34
PIC 101-0406 (3/4")	30
PIC 101-0408 (1")	26
PIC 101-0410 (1 1/4")	23
PIC 101-0412 (1 1/2")	20
PIC 101-0414 (1 3/4")	18
PIC 101-0416 (2")	16
PIC 101-0420 (2 1/2")	12
PIC 101-0424 (3")	9

5/16USS (18)

PIC 102-0504 (1/2")	20
PIC 102-0506 (3/4")	20
PIC 102-0508 (1")	17
PIC 102-0510 (1 1/4")	15
PIC 102-0512 (1 1/2")	14
PIC 102-0514 (1 3/4")	12
PIC 102-0516 (2")	10
PIC 102-0518 (2 1/4")	8
PIC 102-0520 (2 1/2")	8
PIC 102-0524 (3")	7

5/16SAE (24)

PIC 101-0504 (1/2")	20
PIC 101-0506 (3/4")	20
PIC 101-0508 (1")	17
PIC 101-0510 (1 1/4")	15
PIC 101-0512 (1 1/2")	14
PIC 101-0514 (1 3/4")	12
PIC 101-0516 (2")	10
PIC 101-0518 (2 1/4")	8
PIC 101-0520 (2 1/2")	8
PIC 101-0524 (3")	7

3/8USS (16)

PIC 102-0606 (3/4")	15
PIC 102-0608 (1")	13
PIC 102-0610 (1 1/4")	12
PIC 102-0612 (1 1/2")	10
PIC 102-0614 (1 3/4")	9
PIC 102-0616 (2")	8
PIC 102-0618 (2 1/4")	7
PIC 102-0620 (2 1/2")	6
PIC 102-0624 (3")	5

3/8SAE (24)

PIC 101-0606 (3/4")	15
PIC 101-0608 (1")	13
PIC 101-0610 (1 1/4")	12
PIC 101-0612 (1 1/2")	10
PIC 101-0614 (1 3/4")	9
PIC 101-0616 (2")	8
PIC 101-0618 (2 1/4")	7
PIC 101-0620 (2 1/2")	6
PIC 101-0624 (3")	5

7/16USS (14)

PIC 102-0706 (3/4")	10
PIC 102-0708 (1")	10
PIC 102-0710 (1 1/4")	9
PIC 102-0712 (1 1/2")	6
PIC 102-0714 (1 3/4")	6
PIC 102-0716 (2")	5
PIC 102-0718 (2 1/4")	5
PIC 102-0720 (2 1/2")	4
PIC 102-0722 (2 3/4")	4
PIC 102-0724 (3")	3

7/16SAE (20)

PIC 101-0706 (3/4")	10
PIC 101-0708 (1")	10
PIC 101-0710 (1 1/4")	9
PIC 101-0712 (1 1/2")	6
PIC 101-0714 (1 3/4")	6
PIC 101-0716 (2")	5
PIC 101-0720 (2 1/2")	4
PIC 101-0724 (3")	3

1/2USS (13)

PIC 102-0806 (3/4")	7
PIC 102-0808 (1")	6
PIC 102-0810 (1 1/4")	6
PIC 102-0812 (1 1/2")	6
PIC 102-0814 (1 3/4")	5
PIC 102-0816 (2")	3
PIC 102-0820 (2 1/2")	3
PIC 102-0824 (3")	2

1/2SAE (20)

PIC 101-0806 (3/4")	7
PIC 101-0808 (1")	6
PIC 101-0810 (1 1/4")	6
PIC 101-0812 (1 1/2")	5
PIC 101-0816 (2")	3
PIC 101-0820 (2 1/2")	3
PIC 101-0824 (3")	2

METRIC

M4-07

PIC 150-0415 (16MM)	16
PIC 150-0420 (20MM)	15
PIC 150-0425 (25MM)	14

M5-08

PIC 150-0510 (10MM)	17
PIC 150-0512 (12MM)	25
PIC 150-0516 (16MM)	24
PIC 150-0525 (25MM)	20

M6-1.0

PIC 150-0610 (10MM)	20
PIC 150-0612 (12MM)	20
PIC 150-0615 (16MM)	18
PIC 150-0620 (20MM)	17
PIC 150-0625 (25MM)	16
PIC 150-0630 (30MM)	14
PIC 150-0635 (35MM)	13
PIC 150-0640 (40MM)	12
PIC 150-0645 (45MM)	11
PIC 150-0650 (50MM)	9

M8-1.0

PIC 161-0801 (10MM)	9
PIC 161-0802 (20MM)	8
PIC 161-0803 (25MM)	7
PIC 161-0804 (30MM)	6
PIC 161-0806 (50MM)	3

M8-1.25

PIC 150-0812 (12MM)	12
PIC 150-0815 (16MM)	11
PIC 150-0820 (20MM)	12
PIC 150-0825 (25MM)	11
PIC 150-0830 (30MM)	10
PIC 150-0835 (35MM)	9
PIC 150-0840 (40MM)	7
PIC 150-0845 (45MM)	6
PIC 150-0850 (50MM)	5
PIC 150-0860 (60MM)	5
PIC 150-0875 (75MM)	5

M10-1.0

PIC 161-1007 (20MM)	4
PIC 161-1008 (25MM)	4
PIC 161-1009 (30MM)	3
PIC 161-1010 (40MM)	3
PIC 161-1011 (50MM)	3

M10-1.25

PIC 161-1012 (20MM)	4
PIC 161-1013 (25MM)	4
PIC 161-1014 (30MM)	4
PIC 161-1015 (35MM)	3
PIC 161-1016 (40MM)	3
PIC 161-1017 (50MM)	3
PIC 161-1018 (60MM)	2

M10-1.50

PIC 150-1020 (20MM)	6
PIC 150-1025 (25MM)	6
PIC 150-1030 (30MM)	6
PIC 150-1035 (35MM)	5
PIC 150-1040 (40MM)	5
PIC 150-1050 (50MM)	4
PIC 150-1060 (60MM)	3
PIC 150-1070 (70MM)	2

M12-1.25

PIC 161-1219 (25MM)	3
PIC 161-1220 (35MM)	2

M12-1.50

PIC 161-1222 (20MM)	3
PIC 161-1223 (30MM)	2
PIC 161-1224 (40MM)	2
PIC 161-1225 (50MM)	2

M12-1.75

PIC 150-1230 (30MM)	2
PIC 150-1240 (40MM)	2
PIC 150-1245 (45MM)	2
PIC 150-1250 (50MM)	2
PIC 150-1260 (60MM)	2
PIC 150-1275 (75MM)	2

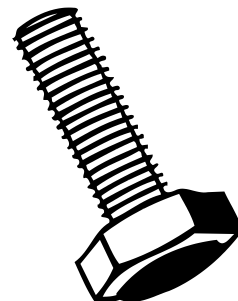
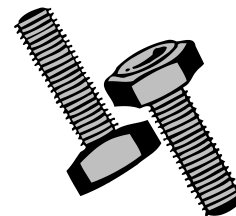



HARDWARE

FASTENERS

Hex Head Cap Bolt Bulk Packs

These grade 5 bolts are zinc plated medium carbon steel. They resist rust and corrosion.

A/S-STOCK:1/4X1/2CS	1/4X1/2 USS HEX HEAD CAP SCREW COURSE..100 PER BOX	\$ 9.65
A/S-STOCK:1/4X3/4CS	1/4X3/4 USS GRADE 5 HEX HEAD CAP SCREW COURSE..100 PER BOX	\$ 6.20
A/S-STOCK:1/4X1CS	1/4X1 USS GRADE 5 HEX HEAD CAP SCREW COURSE..100 PER BOX	\$ 6.65
A/S-STOCK:1/4X1-1/4CS	1/4X1- 1/4 USS GRADE 5 HEX HEAD CAP SCREW COURSE..100 PER BOX	\$ 10.94
A/S-STOCK:1/4X1-1/2CS	1/4X1/2 USS GRADE 5 HEX HEAD CAP SCREW COURSE..100 PER BOX	\$ 8.96
A/S-STOCK:1/4X1-3/4CS	1/4X1-3/4 USS GRADE 5 HEX HEAD CAP SCREW COURSE..100 PER BOX	\$ 5.89
A/S-STOCK:1/4X2CS	1/4X2 USS GRADE 5 HEX HEAD CAP SCREW COURSE..100 PER BOX	\$ 11.76
A/S-STOCK:1/4X2-1/4CS	1/4X2 1/4 HEX HEAD CAP SCREW COURSE..100 PER BOX	\$ 14.16
A/S-STOCK:1/4X2-1/2CS	1/4X2 1/2 USS HEX HEAD CAP SCREW..100 PER BOX	\$ 15.04
A/S-STOCK:5/16X1/4CS	5/16 X 3/4 USS GRADE 5 HEX HEAD CAP SCREW COURSE..100 PER BOX	\$ 9.42
A/S-STOCK:5/16X1CS	5/16 X 1 NC USS GRADE 5 CAP SCREW COURSE..100 PER BOX	\$ 10.76
A/S-STOCK:5/16X1-1/4CS	5/16 X 1 1/4 USS GRADE 5 HEX HEAD CAP SCREW COURSE..100 PER BOX	\$ 12.24
A/S-STOCK:5/16X1-1/2CS	5/16 X 1 1/2 USS GRADE 5 HEX HEAD CAP SCREW COURSE..100 PER BOX	\$ 15.04
A/S-STOCK:5/16X1-3/4CS	5/16 X 1 3/4 USS GRADE 5 HEX HEAD CAP SCREW COURSE..100 PER BOX	\$ 16.56
A/S-STOCK:5/16X2CS	5/16X2 USS GRADE 5 HEX HEAD CAP SCREW COURSE..100 PER BOX	\$ 20.92
A/S-STOCK:5/16X2-1/4CS	5/16X2 1/4 USS GRADE 5 HEX HEAD CAP SCREW..100 PER BOX	\$ 22.62
A/S-STOCK:5/16X2-1/2CS	5/16X2 1/2 USS GRADE 5 HEX HEAD CAP SCREW COURSE..100 PER BOX	\$ 23.44
A/S-STOCK:5/16X3CS	5/16X3 USS GRADE 5 HEX HEAD CAP SCREW COURSE..25 PER BOX	\$ 6.66
A/S-STOCK:1/2X1-1/2CS	1/2X 1 1/2 NC USS GRADE ..HEX HEAD CAP SCREW..COURSE..50 PER BOX	\$ 20.46
A/S-STOCK:3/8X1/2CS	3/8X1/2 USS GRADE 5 HEX HEAD CAP SCREW COURSE..100 PER BOX	\$ 20.46
A/S-STOCK:3/8X3/4CS	3/8X3/4 USS GRADE 5 HEX HEAD CAP SCREW COURSE..100 PER BOX	\$ 13.24
A/S-STOCK:3/8X1CS	3/8 X 1 USS GRADE 5 HEX HEAD CAP SCREW COURSE..100 PER BOX	\$ 15.18
A/S-STOCK:3/8X1-1/4CS	3/8X1-1/4 USS GRADE 5 HEX HEAD CAP SCREW COURSE..100 PER BOX	\$ 24.60
A/S-STOCK:3/8X1-1/2CS	3/8 X 1-1/2 USS GRADE 5 HEX HEAD CAP SCREW COURSE..100 PER BOX	\$ 17.94
A/S-STOCK:3/8X1-3/4CS	3/8X1-3/4 USS GRADE 5 HEX HEAD CAP SCREW COURSE..100 PER BOX	\$ 14.26
A/S-STOCK:3/8X2CS	3/8X2 USS GRADE 5 HEX HEAD CAP SCREW COURSE..100 PER BOX	\$ 26.94
A/S-STOCK:3/8X2-1/4CS	3/8X2-1/4 USS GRADE 5 HEX HEAD CAP SCREW COURSE..100 PER BOX	\$ 11.50
A/S-STOCK:3/8X2-1/2CS	3/8X2-1/2 USS GRADE 5 HEX HEAD CAP SCREW COURSE..100 PER BOX	\$ 13.90
A/S-STOCK:3/8X3CS	3/8X3 USS GRADE 5 HEX HEAD CAP SCREW COURSE..25 PER BOX	\$ 8.25
A/S-STOCK:7/16X3/4CS	7/16X3/4 USS GRADE 5 HEX HEAD CAP SCREW COURSE..100 PER BOX	\$ 20.78
A/S-STOCK:7/16X1CS	7/16X1 USS GRADE 5 HEX HEAD CAP SCREW COURSE..100 PER BOX	\$ 23.00
A/S-STOCK:1/2X2-1/4CS	1/2X 2 1/4 NC USS GRADE 5..HEX HEAD CAP SCREW COURSE..50 PER BOX	\$ 29.10
A/S-STOCK:7/16X1-1/4CS	7/16X1 1/4 USS GRADE 5 HEX HEAD CAP SCREW..100 PER BOX	\$ 24.44
A/S-STOCK:7/16X1-1/2CS	7/16X1 1/2 USS GRADE 5 HEX HEAD CAP SCREW COURSE..100 PER BOX	\$ 15.80
A/S-STOCK:7/16X1-3/4CS	7/16X1 3/4 USS GRADE 5 HEX HEAD CAP SCREW COURSE..100 PER BOX	\$ 33.28
A/S-STOCK:7/16X2CS	7/16X2 USS GRADE 5 HEX HEAD CAP SCREW COURSE..100 PER BOX	\$ 35.86
A/S-STOCK:7/16X2-1/4CS	7/16X2 1/4 USS GRADE 5 HEX HEAD CAP SCREW COURSE..100 PER BOX	\$ 43.08
A/S-STOCK:7/16X2-1/2CS	7/16X2 1/2 USS GRADE 5 HEX HEAD CAP SCREW COURSE..100 PER BOX	\$ 46.72
A/S-STOCK:7/16X3CS	7/16X3 USS GRADE 5 HEX HEAD CAP SCREW COURSE..25 PER BOX	\$ 11.42
A/S-STOCK:1/2X3/4CS	1/2X3/4 USS GRADE 5 HEX HEAD CAP SCREW COURSE..500 PER BOX	\$ 27.82
A/S-STOCK:1/2X1CS	1/2X1 USS GRADE 5 HEX HEAD CAP SCREW COURSE..50 PER BOX	\$ 16.56
A/S-STOCK:1/2X1-1/4CS	1/2X1-1/4 USS GRADE 5 HEX HEAD CAP SCREW COURSE..50 PER BOX	\$ 17.16
A/S-STOCK:1/2X1-3/4CS	1/2X1-3/4 USS GRADE 5 HEX HEAD CAP SCREW..50 PER BOX	\$ 19.76
A/S-STOCK:1/2X2CS	1/2X 2 NC USS GRADE 5..HEX HEAD CAP SCREW COURSE..50 PER BOX	\$ 24.82
A/S-STOCK:1/2X2-1/2CS	1/2X 2 1/2 NC USS GRADE 5..HEX HEAD CAP SCREW COURSE..100 PER BOX	\$ 31.06
A/S-STOCK:1/2X2-3/4CS	1/2X 2 3/4 NC USS GRADE 5..HEX HEAD CAP SCREW COURSE..25 PER BOX	\$ 28.86
A/S-STOCK:1/2X3CS	1/2X 3 NC USS GRADE 5..HEX HEAD CAP SCREW COURSE..25 PER BOX	\$ 31.12

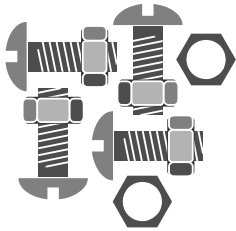
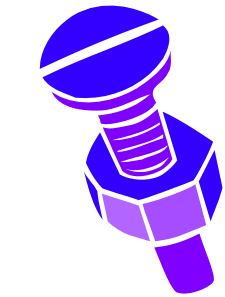

FOR 50+ YEARS,
PARKER
BROTHERS
HAS BEEN
SERVING ATLANTA.
THANK YOU FOR
YOUR CONTINUED
SUPPORT!!

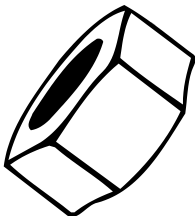

Pik-A-Nut Hex Nuts

These grade 5 nuts are zinc plated medium carbon steel. They resist rust and corrosion.

ALL SIZES	FASTNERS		\$ 3.37
STANDARD	STANDARD	METRIC	
USS NUTS	SAE NUTS	COARSE NUTS	
PIC 109-0400 (1/4-20)	PIC 108-0800 (1/2-20)	PIC 151-1000 (M10-1.5)	15
PIC 109-0500 (5/16-18)	PIC 108-1200 (3/4-16)	PIC 151-1200 (M12-1.75)	8
PIC 109-0600 (3/8-16)	PIC 108-1600 (1-14)	FINE NUTS	
PIC 109-0700 (7/16-14)		PIC 162-0800 (M8-1.0)	14
PIC 109-0800 (1/2-13)	METRIC	PIC 162-1000 (M10-1.0)	9
PIC 109-0900 (9/16-12)	COARSE NUTS	PIC 162-1025 (M10-1.25)	9
SAE NUTS	PIC 151-0400 (M4-0.7)	PIC 162-1225 (M12-1.25)	8
PIC 108-0400 (1/4-28)	PIC 151-0500 (M5-0.8)	PIC 162-1250 (M12-1.5)	8
PIC 108-0500 (5/16-24)	PIC 151-0600 (M6-1.0)		
PIC 108-0600 (3/8-24)	PIC 151-0700 (M7-1.0)		
PIC 108-0700 (7/16-20)	PIC 151-0800 (M8-1.25)		

HARDWARE



FASTENERS

Hex Nut Bulk Packs

These grade 5 nuts are zinc plated medium carbon steel. They resist rust and corrosion.

A/S-STOCK:1/4-NUT	1/4 USS ZINC HEX NUT..100 PER BOX	\$ 2.34
A/S-STOCK:5/16-NUT	5/16 NC USS ZINC HEX NUT..100 PER BOX	\$ 3.22
A/S-STOCK:3/8-NUT	3/8 NC USS ZINC HEX NUT..100 PER BOX	\$ 4.97
A/S-STOCK:7/16-NUT	7/16NC USS ZINC HEX NUT..100 PER BOX	\$ 8.00
A/S-STOCK:1/2-NUT	1/2NC USS ZINC HEX NUT..50 PER BOX	\$ 5.82
A/S-STOCK:5/8-NUT	5/8 NC USS ZINC HEX NUT..25 PER BOX	\$ 5.94
A/S-STOCK:3/4-NUT	3/4 FINISHED HEX NUT ZINC..100 PER BOX	\$ 6.34

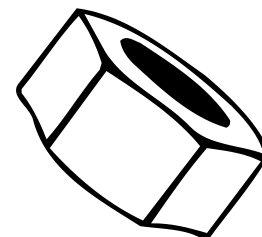

Hex Lock Nut Bulk Packs

These grade 5 lock nuts are zinc plated medium carbon steel. They resist rust and corrosion.

A/S-STOCK:1/4-LOCKNUT	1/4 USS NYLON LOCKNUT..100 PER BOX	\$ 5.17
A/S-STOCK:5/16-LOCKNUT	5/16 USS NYLON LOCKNUT..100 PER BOX	\$ 6.20
A/S-STOCK:3/8-LOCKNUT	3/8 USS NYLON LOCKNUT..100 PER BOX	\$ 10.00
A/S-STOCK:7/16-LOCKNUT	7/16 NYLON LOCKNUT..100 PER BOX	\$ 6.72
A/S-STOCK:1/2-LOCKNUT	1/2 NYLON LOCK NUT..50 PER BOX	\$ 9.24
A/S-STOCK:5/8-LOCKNUT	5/8 USS NYLON LOCKNUT..25 PER BOX ..1BOX	\$ 8.57
A/S-STOCK:3/4-LOCKNUT	3/4 NYLON LOCK NUT..20 PER BOX	\$ 12.82

MONDAY-FRIDAY
8am-5pm a helpful
HUMAN voice will
always answer the
phone
(770)474-1286

Hex Wing Nut Bulk Packs

These grade 5 wing nuts are zinc plated medium carbon steel. They resist rust and corrosion.

A/S-STOCK:10-24-WINGNUT	10-24 COLD FORGED WING NUT..100 PER BOX	\$ 8.52
A/S-STOCK:1/4-20-WINGNUT	1/4-20 COLD FORGED WING NUT..100 PER BOX	\$ 11.44

Pik-A-Nut Flat Washers

These grade 2 washers are zinc plated alloy steel. They resist rust and corrosion.

ALL SIZES	FASTNERS	\$ 3.37
-----------	----------	---------

STANDARD

USS FLAT WASHERS

PIC 120-0400 (1/4)	87
PIC 120-0500 (5/16)	60
PIC 120-0600 (3/8)	40
PIC 120-0700 (7/16)	25
PIC 120-0800 (1/2)	20
PIC 120-1000 (5/8)	10
PIC 120-1200 (3/4)	7

SAE FLAT WASHERS

PIC 118-0300 (3/16)	160
PIC 118-0400 (1/4)	90
PIC 118-0500 (5/16)	90
PIC 118-0600 (3/8)	60

STANDARD

SAE FLAT WASHERS

PIC 118-0700 (7/16)	50
PIC 118-0800 (1/2)	27
PIC 118-0900 (9/16)	23
PIC 118-1000 (5/8)	16
PIC 118-1200 (3/4)	12

METRIC

FLAT WASHERS

PIC 154-0500 (M5)	70
PIC 154-0600 (M6)	60
PIC 154-0800 (M8)	42
PIC 154-1000 (M10)	25
PIC 154-1200 (M12)	15

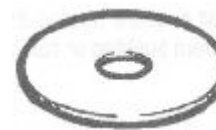

Flat Washer Bulk Packs

These flat washers are zinc plated alloy steel. They resist rust and corrosion.

A/S-STOCK:1/4-FLATWASHER	1/4 FLATWASHER SAE..100 PER BOX	\$ 1.82
A/S-STOCK:5/16-FLATWASHER	5/16 FLAT WASHER SAE..100 PER BOX	\$ 1.82
A/S-STOCK:3/8-FLATWASHER	3/8 FLATWASHER SAE..100 PER BOX	\$ 2.07
A/S-STOCK:7/16-FLATWASHER	7/16 FLATWASHER SAE..100 PER BOX	\$ 3.26
A/S-STOCK:1/2-FLATWASHER	1/2 FLATWASHER SAE..100 PER BOX..	\$ 6.30
A/S-STOCK:5/8-FLATWASHER	5/8 FLATWASHER SAE..100 PER BOX	\$ 8.94
A/S-STOCK:3/4-FLATWASHER	3/4 FLATWASHER SAE..50 PER BOX	\$ 6.79



Pik-A-Nut Split Washers

These grade 2 washers are zinc plated alloy steel. They resist rust and corrosion.

ALL SIZES	FASTNERS	\$ 3.37
-----------	----------	---------

STANDARD

SPLIT WASHERS

PIC 117-0300 (3/16)	220
PIC 117-0400 (1/4)	140
PIC 117-0500 (5/16)	100
PIC 117-0600 (3/8)	80
PIC 117-0700 (7/16)	60
PIC 117-0800 (1/2)	40

METRIC

SPLIT WASHERS

PIC 152-0500 (M5)	75
PIC 152-0600 (M6)	50
PIC 152-0700 (M7)	35
PIC 152-0800 (M8)	33
PIC 152-1000 (M10)	30
PIC 152-1200 (M12)	20



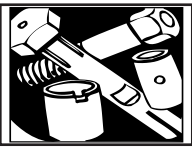

HARDWARE

FASTENERS

Split Washer Bulk Packs

These split washers are zinc plated alloy steel. They resist rust and corrosion.

A/S-STOCK:1/4-LOCKWASHER	1/4 LOCKWASHER..100 PER BOX	\$ 1.47
A/S-STOCK:5/16-LOCKWASHER	5/16 LOCKWASHER..100 PER BOX	\$ 2.58
A/S-STOCK:3/8-LOCKWASHER	3/8 LOCKWASHER..100 PER BOX	\$ 3.91
A/S-STOCK:7/16-LOCKWASHER	7/16 LOCKWASHER..100 PER BOX	\$ 5.80
A/S-STOCK:1/2-LOCKWASHER	1/2 LOCKWASHER..100 PER BOX	\$ 7.97
A/S-STOCK:5/8-LOCKWASHER	5/8 LOCKWASHER..100 PER BOX	\$ 14.14
A/S-STOCK:3/4-LOCKWASHER	3/4 LOCKWASHER..100 PER BOX	\$ 23.26

Fender Washer Bulk Packs

These fender washers are zinc plated alloy steel. They resist rust and corrosion.

A/S-STOCK:1/4-FENWASH	1/4X1 1/2 FENDER WASHER 100 PER BOX	\$ 9.02
A/S-STOCK:5/16-FENWASH	5/16X1-1/2 FENDER WASHER 100 PER BOX	\$ 8.78
A/S-STOCK:3/8-FENWASH	3/8X1-1/2 FENDER WASHER ..100 PER BOX	\$ 8.56

Pik-A-Nut Cotter Pins

These cotter pins are zinc plated low carbon steel. They resist rust and corrosion.

ALL SIZES	FASTNERS	\$ 3.37
STANDARD	PIC 124-2008 (1/8X1)	100
COTTER PINS	PIC 124-2010 (1/8X1 1/4)	125
PIC 124-1006 (1/16X3/4)	PIC 124-2012 (1/8X1 1/2)	80
PIC 124-1008 (1/16X1)	PIC 124-2014 (1/8X1 3/4)	70
PIC 124-1506 (3/32X3/4)	PIC 124-2016 (1/8X2)	50
PIC 124-1508 (3/32X1)	PIC 124-2508 (5/32X1 3/16)	70
PIC 124-1512 (3/32X1 1/2)	PIC 124-2512 (5/32X1 1/2)	40
PIC 124-1516 (3/32X2)	PIC 124-2516 (5/32X2)	30
PIC 124-1806 (7/64X3/4)	PIC 124-3016 (3/16X2)	20
PIC 124-1808 (7/64X1)	PIC 155-0545 (13/64X1 25/32)	12

Cotter Pin Bulk Packs

These cotter pins are zinc plated low carbon steel. They resist rust and corrosion.

STANDARD

A/S-STOCK:1/8X1 1/2-500	1/8X1-1/2 COTTER PIN..500 PER BOX	\$ 15.55
A/S-STOCK:1/8X1 1/2-800	1/8X1-1/2 COTTER PIN..800 PER BOX	\$ 26.00
A/S-STOCK:1/8X2-800	1/8X2 COTTER PINS..800 PER BOX	\$ 28.80

Self Tapping Tex Screws Bulk Packs

A/S-STOCK:8X1/2-HSD	8X1/2 HEX SELF DRILLING TEX..100 PER BOX	\$ 5.94
A/S-STOCK:8X3/4-HSD	8X3/4 HEX SELF DRILLING TEX..100 PER BOX	\$ 4.10
A/S-STOCK:8X1-HSD	8X1 HEX SELF DRILLING TEX..100 PER BOX	\$ 3.30
A/S-STOCK:8X1-1/4-HSD	8X1-1/4 HEX SELF DRILLING TEX..100 PER BOX	\$ 5.10
A/S-STOCK:8X1-1/2-HSD	8X1-1/2 HEX SELF DRILLING TEX..100 PER BOX	\$ 5.86
A/S-STOCK:8X2-HSD	8X2 HEX SELF DRILLING TEX..100 PER BOX	\$ 8.02
A/S-STOCK:10X1/2-HSD	10X1/2 HEX SELF DRILLING TEX..100 PER BOX	\$ 7.30
A/S-STOCK:10X3/4-HSD	10X3/4 HEX SELF DRILLING TEX..100 PER BOX	\$ 5.20
A/S-STOCK:10X1-HSD	10X1 HEX SELF DRILLING TEX..100 PER BOX	\$ 4.86
A/S-STOCK:10X1-1/4-HSD	10X1-1/4 HEX SELF DRILLING TEX..100 PER BOX	\$ 5.88
A/S-STOCK:10X1-1/2-HSD	10X1-1/2 HEX SELF DRILLING TEX..100 PER BOX	\$ 6.70
A/S-STOCK:10X2-HSD	10X2 HEX SELD DRILLING TEX..100 PER BOX	\$ 8.62
A/S-STOCK:12X3/4-HSD	12X3/4 HEX SELF DRILLING TEX..100 PER BOX	\$ 7.66
A/S-STOCK:12X1-HSD	12X1 HEX SELF DRILLING TEX..100 PER BOX..	\$ 10.36
A/S-STOCK:12X1-1/4-HSD	12X1-1/4 HEX SELF DRILLING TEX..100 PER BOX	\$ 9.42
A/S-STOCK:12X1-1/2-HSD	12X1-1/2 HEX SELF DILLING TEX..100 PR BOX	\$ 10.26
A/S-STOCK:12X2-HSD	12X2 HEX SELF DRILLING TEX..100 PER BOX	\$ 11.78
A/S-STOCK:14X1-HSD	14X1 HEX SELF DRILLING TEX..100 PER BOX	\$ 10.26

FASTENER ASSORTMENTS

Pik-A-Nut Shop Assortments

These assortments are designed to give automotive garages the nuts, bolts, and washers they will need. They come in a sturdy wall mounted cabinet for convenient storage

PIC:625120	STANDARD SHOP FASTENER ASSORTMENT	\$ 135.93
PIC:625130	METRIC SHOP FASTENER ASSORTMENT	\$ 159.11

HARDWARE



PAINT BRUSHES

Paint Brushes

HAR:1IN-BRUSH	1" PAINT BRUSH..1 EACH	\$ 1.00
HAR:2IN-BRUSH	2" PAINT BRUSH..1 EACH	\$ 1.08
HAR:3IN-BRUSH	3" PAINT BRUSH..1 EACH	\$ 1.51
HAR:4IN-BRUSH	4" PAINT BRUSH..1 EACH	\$ 3.90

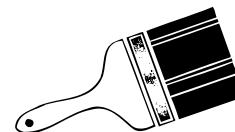

SPRAY PRIMER

Krylon Spray Primer

Apply to bare metal before painting. Primer helps to provide a smoother finish by filling in small scratches.

KRY:K1314	PLATINUM PRIMER..12 OZ CAN	\$ 4.71
KRY:K51315	WHITE PRIMER..12 OZ CAN	\$ 4.86
KRY:K51317	RUDDY BROWN PRIMER..12 OZ CAN	\$ 4.98
KRY:K51318	GRAY PRIMER..12 OZ CAN	\$ 4.98
KRY:K51350	ZINC RICH PRIMER..12 OZ CAN	\$ 6.07
KRY:K51366	BLACK PRIMER..12 OZ CAN	\$ 6.18



Other Brands

HAR:55279	GRAY ENAMEL PRIMER..10 OZ CAN	\$ 2.40
-----------	-------------------------------	---------

SPRAY PAINT

Krylon Spray Paint

Krylon spray paint dries quickly and provides a durable finish.

KRY:DE1604	UNIVERSAL GRAY..12 OZ CAN	\$ 4.65
KRY:K51301	ACRYLIC CLEAR..12 OZ CAN	\$ 4.98
KRY:K51401	BRIGHT SILVER..12 OZ CAN	\$ 4.72
KRY:K51402	HIGH HEAT ALUMINUM ..12 OZ CAN	\$ 4.72
KRY:K51403	DULL ALUMINUM ..12 OZ CAN	\$ 4.73
KRY:K51404	CHROME ALUMINUM ..12 OZ CAN	\$ 5.22
KRY:HB104	GLOSS WHITE FLEET PAINT ..16 OZ CAN	\$ 5.41
KRY:K51501	GLOSSY WHITE..12 OZ CAN	\$ 4.61
KRY:K51502	FLAT WHITE..12 OZ CAN	\$ 4.71
KRY:K51503	ANTIQU WHITE..12 OZ CAN	\$ 4.71
KRY:K51505	HIGH HEAT WHITE..12 OZ CAN	\$ 6.05
KRY:K51506	ALMOND..12 OZ CAN	\$ 4.71
KRY:K51517	CASTCOAT ENGINE ENAMEL..12 OZ CAN	\$ 4.71
KRY:HB101	GLOSS BLACK FLEET PAINT..16 OZ CAN	\$ 5.41
KRY:K51601	GLOSSY BLACK..12 OZ CAN	\$ 4.98
KRY:K51602	ULTRA FLAT BLACK..12 OZ CAN	\$ 4.98
KRY:K51605	DOVE GRAY..12 OZ CAN	\$ 4.98
KRY:K51608	SMOKE GRAY..12 OZ CAN	\$ 4.86
KRY:K51611	UNIVERSAL GRAY..12 OZ CAN	\$ 4.73
KRY:DE1613	UNIVERSAL BLACK..12 OZ CAN	\$ 4.71
KRY:K51613	SEM I FLAT BLACK..12 OZ CAN	\$ 5.18
KRY:K51614	HIGH HEAT BLACK..12 OZ CAN	\$ 4.64
KRY:K51615	BLACK LACQUER..12 OZ CAN	\$ 4.71
KRY:DE1650	CAST COAT ALUMINUM DUPLICOLOR..12 OZ CAN	\$ 4.89
KRY:DE1651	CAST COAT IRON PAINT..12 OZ CAN	\$ 4.71
KRY:K51701	BRIGHT GOLD..12 OZ CAN	\$ 4.72
KRY:K51705	ENGINE GOLD..12 OZ CAN	\$ 4.72
KRY:K51706	GOLD METALLIC..12 OZ CAN	\$ 4.72
KRY:K51801	CHROME YELLOW..12 OZ CAN	\$ 4.72
KRY:K51805	NEW CATERPILLAR YELLOW..12 OZ CAN	\$ 5.13
KRY:K51806	SUN FLOWER YELLOW 12OZ	\$ 4.71
KRY:K51809	SCHOOL BUS YELLOW..12 OZ CAN	\$ 5.12
KRY:K51813	DAISY - OSHA SAFETY - YELLOW..12 OZ CAN	\$ 5.08
KRY:K51816	BRIGHT YELLOW..12 OZ CAN	\$ 4.71
KRY:K51817	MOSS - JOHN DEERE - GREEN..12 OZ CAN	\$ 4.97
KRY:K51819	OLD CATERPILLAR YELLOW..12 OZ CAN	\$ 4.71
KRY:K51820	MANDARIN ORANGE..12 OZ CAN	\$ 5.12
KRY:K51901	REGAL BLUE..12 OZ CAN	\$ 4.49
KRY:K51903	METALLIC BLUE..12 OZ CAN	\$ 4.72
KRY:K51908	CHEVROLET BLUE..12 OZ CAN	\$ 4.72
KRY:DE1601	FORD BLUE..12 OZ CAN	\$ 4.75
KRY:K51910	TRUE BLUE..12 OZ CAN	\$ 5.19
KRY:K51923	FORD DARK BLUE..12 OZ CAN	\$ 4.71





HARDWARE

SPRAY PAINT

Krylon Spray Paint

Krylon spray paint dries quickly and provides a durable finish.

KRY:K51928	CHRYSLER BLUE..12 OZ CAN	\$ 4.71
KRY:K51929	PLUM PURPLE..12 OZ CAN	\$ 4.71
KRY:K51930	GM BLUE..12 OZ CAN	\$ 4.71
KRY:K52001	HUNTER GREEN..12 OZ CAN	\$ 4.86
KRY:K52003	JADE - OSHA SAFETY - GREEN..12 OZ CAN	\$ 4.71
KRY:K52012	CLOVER GREEN..12 OZ CAN	\$ 5.10
KRY:K52013	ALPINE GREEN..12 OZ CAN	\$ 4.71
KRY:K52101	CHERRY RED..12 OZ CAN	\$ 4.71
KRY:K52103	INTERNATIONAL HARVESTER RED..12 OZ CAN	\$ 4.71
KRY:K52106	FORD RED..12 OZ CAN	\$ 4.71
KRY:K52108	BANNER RED..12 OZ CAN	\$ 4.87
KRY:K52111	CHRYSLER RED..12 OZ CAN	\$ 4.71
KRY:K52114	BUICK RED..12 OZ CAN	\$ 4.71
KRY:K52116	SCARLET RED..12 OZ CAN	\$ 5.27
KRY:K52117	DUSTY PINK..12 OZ CAN	\$ 4.71
KRY:K52118	BURGUNDY..12 OZ CAN	\$ 4.71
KRY:DE1620	CHEVROLET ORANGE..12 OZ CAN	\$ 4.72
KRY:K52410	POPSICLE - OSHA SAFETY - ORANGE..12 OZ CAN	\$ 4.71
KRY:K52501	LEATHER BROWN..12 OZ CAN	\$ 5.06
KRY:K52504	BEIGE..12 OZ CAN	\$ 4.71
KRY:K53102	FLORESCENT YELLOW ORANGE..12 OZ CAN	\$ 5.94
KRY:K53206	EPOXY PAINT BLACK..12 OZ CAN	\$ 4.80
KRY:K7005	POLYURETHANE GLOSS..12 OZ CAN	\$ 4.71
KRY:K7006	POLYURETHANE SATIN..12 OZ CAN	\$ 4.78
KRY:K8143	CAMOUFLAGE GREEN..12 OZ CAN	\$ 4.71
KRY:VS5	BRIGHT BLUE VINYL AND FABRIC..12 OZ CAN	\$ 4.71



Other Brands

HAR:51101	CLEAR..11 OZ CAN	\$ 2.99
HAR:51107	DOVE GRAY..11 OZ CAN	\$ 3.69
HAR:51116	PURPLE..10 OZ CAN	\$ 2.54
HAR:52460	BBQ HIGH TEMPERATURE BLACK..10 OZ CAN	\$ 4.92
HAR:55270	CHERRY RED..10 OZ CAN	\$ 2.40
HAR:55271	HUNTER GREEN..10 OZ CAN	\$ 2.40
HAR:55273	ALUM INUM ..10 OZ CAN	\$ 2.40
HAR:55274	GLOSS WHITE..10 OZ CAN	\$ 2.40
HAR:55275	FLAT BLACK..10 OZ CAN	\$ 2.40
HAR:55276	GLOSS BLACK..10 OZ CAN	\$ 2.40
HAR:55278	ROYAL BLUE..10 OZ CAN	\$ 2.40
HAR:55280	FLAT WHITE..10 OZ CAN	\$ 2.25
HAR:55272	CANARY YELLOW..10 OZ CAN	\$ 2.40
HAR:223083	METALLIC DARK BRONZE..11 OZ CAN	\$ 2.99
HAR:16-669	BLUE INVERTED TIP PAINT..13 OZ CAN	\$ 3.96
HAR:16-668	GREEN INVERTED TIP PAINT..13 OZ CAN	\$ 4.45
HAR:20669	BLUE INVERTED TIP PAINT..18 OZ CAN	\$ 3.96



Upside Down Paint

KRY:K55849	INVERTED TIP WHITE..12 OZ CAN	\$ 4.78
KRY:K57162	INVERTED TIP YELLOW..12 OZ CAN	\$ 4.78
KRY:K5854	INVERTED TIP FLORESCENT ORANGE..12 OZ CAN	\$ 4.78
KRY:K7314	WATER BASED INVERTED TIP GREEN..12 OZ CAN	\$ 4.28
KRY:K7315	WATER BASED INVERTED TIP BLUE..12 OZ CAN	\$ 4.28
HAR:20668	GREEN INVERTED TIP PAINT..18 OZ CAN	\$ 3.96
HAR:20653	BLUE INVERTED TIP PAINT..18 OZ CAN	\$ 5.04
HAR:20655	GREEN INVERTED TIP PAINT..18 OZ CAN	\$ 4.06
HAR:16-652	WHITE INVERTED TIP PAINT..13 OZ CAN	\$ 3.96
HAR:16-654	FLUORESCENT RED INVERTED TIP PAINT..13 OZ CAN	\$ 4.05
HAR:16-657	FLUORESCENT ORANGE INVERTED TIP PAINT..13 OZ CAN	\$ 4.38
HAR:16-671	SAFTY RED INVERTED TIP PAINT..13 OZ CAN	\$ 3.96
HAR:16-676	HIGH VISIBILITY YELLOW INVERTED TIP PAINT..13 OZ CAN	\$ 4.30
HAR:16-677	CAUTION / HIGH WAY YELLOW INVERTED TIP PAINT..13 OZ CAN	\$ 3.96
HAR:20631	CLEAR INVERTED TIP PAINT..18 OZ CAN	\$ 4.86
HAR:20642	WHITE INVERTED TIP PAINT..18 OZ CAN	\$ 6.24

HARDWARE



CAULK

Caulk

HAR:30060	WHITE LIGHTING CAULK..11 OZ CARTRIDGE	\$ 2.18
-----------	---------------------------------------	---------

Household Silicone

HAR:08641	CLEAR HOUSEHOLD SILICONE..10.3 OZ CARTRIDGE	\$ 5.00
HAR:08642	BLACK HOUSEHOLD SILICONE..10.3 OZ CARTRIDGE	\$ 4.73
HAR:08643	ALUMINUM HOUSEHOLD SILICONE..10.3 OZ CARTRIDGE	\$ 4.73

Caulk Gun

HAR:101	CAULK GUN..1 EACH	\$ 5.44
HAR:CAULKING-GUN	CAULK GUN..1 EACH	\$ 7.28

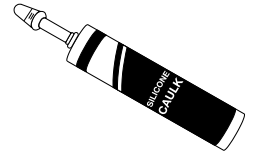

LIGHTING

Flash Lights

PRI:6009	FLASH LIGHT WITH BATTERIES..1 EACH	\$ 8.97
----------	------------------------------------	---------

Light Bulbs

SYL:50WATT	ROUGH SERVICE BULB..1 EACH	\$ 0.94
SYL:75WATT	ROUGH SERVICE BULB..1 EACH	\$ 0.85
SYL:100WATT	ROUGH SERVICE BULB..1 EACH	\$ 1.12
SYL:150WATT	FLOOD LIGHT BULB..1 EACH	\$ 3.79
SYL:TS-RSB	75 WATT PLASTIC COATED BULB..1 EACH	\$ 1.79
SYL:TS-RSB-100	100 WATT PLASTIC COATED BULB..1 EACH	\$ 1.79

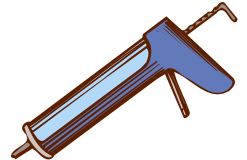

Fluorescent Bulbs

HAR:F40T12CW	48" FLUORESCENT BULB 2 PRONG..30 PER CASE	\$ 66.15
HAR:F96T12CW	96" FLUORESCENT BULB 1 PRONG..15 PER CASE	\$ 116.53

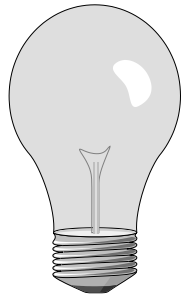

Flood Light Bulbs

HAR:FLOODLIGHT	120 WATT FLOOD LIGHT BULB..1 EACH	\$ 6.19
SYL:FLOOD-LIGHT	150 WATT FLOOD LIGHT..1 EACH	\$ 5.25
SYL:FLOOD-BULB	72 WATT FLOOD LIGHT..1 EACH	\$ 2.63
SYL:500-WATT	HALOGEN FLOOD LIGHT..2 PER PACK	\$ 11.43

12 Volt Light Bulbs

SYL:12V	12 VOLT ROUGH SERVICE BULB..1 EACH	\$ 1.25
---------	------------------------------------	---------

BATTERIES

Batteries

BAT:AA-24	AA BATTERIES..24 PER PACK	\$ 14.69
BAT:AAA-24	AAA BATTERIES..24 PER PACK	\$ 12.04
BAT:C-12	C BATTERIES..12 PER PACK	\$ 15.44
BAT:D-12	D BATTERIES..12 PER PACK	\$ 17.04
BAT:9V-8	9 VOLT BATTERIES..8 PER PACK	\$ 15.29

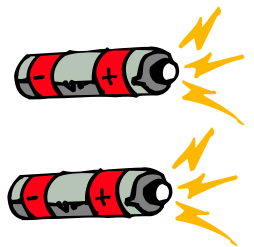

TRAILER ACCESSORIES

Chrome Hitches

PRI:50110	1 7/8" DIAMETER 3/4" X 1 3/4" TRAILER BALL..1 EACH	\$ 9.92
PRI:50500	1 7/8" DIAMETER 3/4" X 2 5/16" TRAILER BALL..1 EACH	\$ 6.87
PRI:50010	2 5/16" DIAMETER 1 1/4" X 2 1/4" TRAILER BALL..1 EACH	\$ 13.07

Anchor Point

PRI:05649	CHROME ANCHOR POINT..2 PER PACK	\$ 9.75
-----------	---------------------------------	---------

Wheel Chocks

W/W:TIRE-CHOCK	BLACK WHEEL CHOCK BLOCK..1 EACH	\$ 17.50
----------------	---------------------------------	----------



STRAPS AND TARPS

Blue Plastic Tarps

CAR:75201	6' X 8' BLUE TARP..1 EACH	\$ 7.32
CAR:75203	8' X 10' BLUE TARP..1 EACH	\$ 4.69
CAR:75205	10' X 12' BLUE TARP..1 EACH	\$ 7.30
CAR:75207	12' X 16' BLUE TARP..1 EACH	\$ 10.75
CAR:75209	16' X 20' BLUE TARP..1 EACH	\$ 18.82



HARDWARE

STRAPS AND TARPS

Solder Seal/Gunk Straps

These heavy duty stretchable rubber straps are designed with hooks in both ends to secure cargo of any size.

SSG:R7-9B	9 INCH HOLD-ZIT STRAP..1 EACH	\$ 1.22
SSG:R7-15B	15 INCH HOLD-ZIT STRAP..1 EACH	\$ 0.95
SSG:R7-22B	22 INCH HOLD-ZIT STRAP..1 EACH	\$ 1.56
SSG:R7-31B	31 INCH HOLD-ZIT STRAP..1 EACH	\$ 2.16
SSG:R7-41B	41 INCH HOLD-ZIT STRAP..1 EACH	\$ 3.33

Other Brands

PRI:84082	24" SUPER STRONG BUNGEE STRAP..1 EACH	\$ 7.69
PRI:84084	36" SUPER STRONG BUNGEE STRAP..1 EACH	\$ 9.59

Strap Assortments

PRI:84097	6 PIECE BUNGEE STRAP ASSORTMENT ..1 EACH	\$ 9.49
PRI:32448	8 PIECE BUNGEE STRAP ASSORTMENT ..1 EACH	\$ 9.49
PRI:82451	10 PIECE BUNGEE CORD ASSORTMENT ..1 EACH	\$ 9.95

Ratchet Tie Down Straps

PRI:84002	1" X 6' RATCHET TIE-DOWN STRAP..2 PER PACK	\$ 14.43
PRI:52349	1" X 6' RATCHET TIE-DOWN STRAP..4 PER PACK	\$ 11.99
PRI:84023	1" X 15' RATCHET TIE DOWN WITH J HOOKS..1 EACH	\$ 9.79
PRI:03508	1" X 8' RATCHET TIE-DOWN STRAP..4 PER PACK	\$ 28.87
PRI:04622	2" X 27' RATCHET TIE-DOWN STRAP..1 EACH	\$ 24.95
PRI:04627	2" X 30' RATCHET TIE-DOWN STRAP..1 EACH	\$ 29.54
W/W:5/16-RATCHET	5/16" X 3/8" RATCHET CHAIN BINDER..1 EACH	\$ 40.48

DRILL BITS

KanKut Drill Bits

These premium drill bits are made from the finest materials. They are designed to provide worry free service for an extended life

KUT:KK5-1/2	JOBBER LENGTH DRILL BIT..1 EACH	\$ 12.02
KUT:KK5-1/4	JOBBER LENGTH DRILL BIT..1 EACH	\$ 3.97
KUT:KK5-1/8	JOBBER LENGTH DRILL BIT..1 EACH	\$ 1.91
KUT:KK5-3/8	JOBBER LENGTH DRILL BIT..1 EACH	\$ 9.83
KUT:KK5-1/16	JOBBER LENGTH DRILL BIT..1 EACH	\$ 1.76
KUT:KK5-3/16	JOBBER LENGTH DRILL BIT..1 EACH	\$ 2.76
KUT:KK5-5/16	JOBBER LENGTH DRILL BIT..1 EACH	\$ 5.99
KUT:KK5-7/16	JOBBER LENGTH DRILL BIT..1 EACH	\$ 11.41
KUT:KK5-9/16	JOBBER LENGTH DRILL BIT..1 EACH	\$ 33.47
KUT:KK5-3/32	JOBBER LENGTH DRILL BIT..1 EACH	\$ 1.74
KUT:KK5-5/32	JOBBER LENGTH DRILL BIT..1 EACH	\$ 2.39
KUT:KK5-7/32	JOBBER LENGTH DRILL BIT..1 EACH	\$ 3.18
KUT:KK5-9/32	JOBBER LENGTH DRILL BIT..1 EACH	\$ 4.83
KUT:KK5-11/32	JOBBER LENGTH DRILL BIT..1 EACH	\$ 6.88
KUT:KK5-13/32	JOBBER LENGTH DRILL BIT..1 EACH	\$ 10.14
KUT:KK5-15/32	JOBBER LENGTH DRILL BIT..1 EACH	\$ 12.86
KUT:KK5-5/64	JOBBER LENGTH DRILL BIT..1 EACH	\$ 1.76
KUT:KK5-7/64	JOBBER LENGTH DRILL BIT..1 EACH	\$ 2.00
KUT:KK5-9/64	JOBBER LENGTH DRILL BIT..1 EACH	\$ 2.27
KUT:KK5-11/64	JOBBER LENGTH DRILL BIT..1 EACH	\$ 2.52
KUT:KK5-13/64	JOBBER LENGTH DRILL BIT..1 EACH	\$ 3.05
KUT:KK5-15/64	JOBBER LENGTH DRILL BIT..1 EACH	\$ 3.62
KUT:KK5-17/64	JOBBER LENGTH DRILL BIT..1 EACH	\$ 5.63
KUT:KK5-19/64	JOBBER LENGTH DRILL BIT..1 EACH	\$ 5.48
KUT:KK5-21/64	JOBBER LENGTH DRILL BIT..1 EACH	\$ 6.57
KUT:KK5-23/64	JOBBER LENGTH DRILL BIT..1 EACH	\$ 8.35
KUT:KK5-25/64	JOBBER LENGTH DRILL BIT..1 EACH	\$ 8.60
KUT:KK5-27/64	JOBBER LENGTH DRILL BIT..1 EACH	\$ 9.92
KUT:KK5-29/64	JOBBER LENGTH DRILL BIT..1 EACH	\$ 12.97
KUT:KK5-31/64	JOBBER LENGTH DRILL BIT..1 EACH	\$ 14.49
KUT:KK12-3/4	JOBBER LENGTH DRILL BIT..1 EACH	\$ 50.19
KUT:KK5-1	JOBBER LENGTH DRILL BIT..1 EACH	\$ 4.26
KUT:KK12-5/8	JOBBER LENGTH DRILL BIT..1 EACH	\$ 48.35
KUT:KK12-7/8	JOBBER LENGTH DRILL BIT..1 EACH	\$ 60.61



Parker Brothers
gladly accepts
Visa, Mastercard
Discover &
American Express

HARDWARE



DRILL BITS

KanKut Drill Bits

These premium drill bits are made from the finest materials. They are designed to provide worry free service for an extended life

KUT:KK12-11/16	JOBBER LENGTH DRILL BIT..1 EACH	\$ 47.82
KUT:KK2-1/8	DOUBLE SIDED DRILL BIT..1 EACH	\$ 2.59
KUT:KK2-3/16	DOUBLE SIDED DRILL BIT..1 EACH	\$ 2.96

KanKut Drill Bit Assortments

KUT:13KK5-13P C	JOBBER LENGTH DRILL BIT ASSORTMENT	\$ 36.69
KUT:15KK5-15P C	JOBBER LENGTH DRILL BIT ASSORTMENT	\$ 102.53
KUT:21KK5-21P C	JOBBER LENGTH DRILL BIT ASSORTMENT	\$ 97.62
KUT:29KK5-29P C	JOBBER LENGTH DRILL BIT ASSORTMENT	\$ 158.52

SHOVELS AND SCRAPERS

Shovels

HAR:SCOOP	ALUMINUM HANDLE SCOOP SHOVEL..1 EACH	\$ 35.91
HAR:15-545	WOOD HANDLE SQUARE SHOVEL..1 EACH	\$ 12.99

Floor Scrapers

HAR:SCRAPER	FLOOR SCRAPER..1 EACH	\$ 26.00
-------------	-----------------------	----------

PACKAGING MATERIALS

Metal Banding

TAP:1/2-BANDING	1/2" x .020 STEEL STRAPPING..3000'	\$ 181.50
TAP:5/8-BANDING	1/2" x .023 STEEL STRAPPING..2500'	\$ 99.87
TAP:3/4-BANDING	1/2" x .023 STEEL STRAPPING..2000'	\$ 175.00

Metal Banding Clips

TAP:CLIPS-1/2	1/2" STEEL BANDING CLIPS..5000 PER PACK	\$ 110.00
TAP:CLIPS-3/4	3/4" STEEL BANDING CLIPS..5000 PER PACK	\$ 99.04

Banding Carts

TAP:316S	STEEL STRAP CART	\$ 354.00
TAP:316P	POLY STRAP CART	\$ 354.00

Card Board

TAP:23695	24" X 250' CORRUGATED CARDBOARD ROLL	\$ 28.50
TAP:75F30	30" X 250' CORRUGATED CARDBOARD ROLL	\$ 37.85
TAP:98565	30" X 250' CORRUGATED CARDBOARD ROLL	\$ 33.99

SPRAYERS

Pump Up Sprayers

LAG-STOCK:RLF 1992A	2 GAL ACID RESISTANT PUMP UP SPRAYER..1 EACH	\$ 30.79
LAG-STOCK:RLF 1973	3 GAL POLY SPRAYER WITH HOSE..1 EACH	\$ 35.40

Air Powered Sprayers

BER:0971	PAINTED STEEL SPRAYER ..32 OZ	\$ 35.24
----------	-------------------------------	----------

WEED KILLER AND INSECT REPELLENT

Weed Killer

ABC:WEEDKILLER-P	KNOCKOUT WEED KILLER..1 GAL	\$ 135.00
ABC:WEEDKILLER-1G	KNOCKOUT WEED KILLER..5 GAL	\$ 32.39
ABC:WEEDKILLER-D	KNOCKOUT WEED KILLER..55 GAL	\$ 1243.00

Insect Repellent

ABC:ANT&ROACH-C	ANT AND ROACH SPRAY..12/20 OZ CANS	\$ 46.31
-----------------	------------------------------------	----------

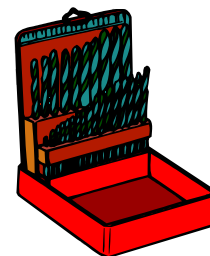

MONDAY-FRIDAY
8am-5pm a helpful
HUMAN voice will
always answer the
phone
(770)474-1286



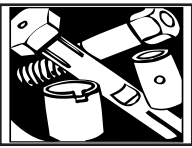

HARDWARE

MISCELLANEOUS PRODUCTS

"Junk Yard" Marker

W/W:KEEP-TRAK	YELLOW "JUNKYARD" MARKER..1 EACH	\$ 5.09
W/W:PAINT-MARK-W	WHITE PAINT MARKER..1 EACH	\$ 4.50
W/W:PAINT-MARK-Y	YELLOW PAINT MARKER..1 EACH	\$ 4.50

Metal Trash Can

SHE:EMPTY-KEG	EMPTY 16 GAL KEG..1 EACH	\$ 27.00
---------------	--------------------------	----------

Ice Melt

CLN:ICE-MELT	CALCIUM CHLORIDE..50 LB	\$ 22.00
--------------	-------------------------	----------

Vinyl Siding Wash

Used to clean vinyl siding, aluminum siding, awnings and driveways. Attaches to water hose for easy spray and rinse convenience. Reaches 25'.

SPR:39302	VINYL SIDING WASH..35 OZ SPRAY BOTTLE	\$ 7.33
-----------	---------------------------------------	---------

Concrete Repair

LPS:60943	FLOOR PATCH RENEWAL COMPOSITE..40 LB KIT	\$ 235.77
-----------	--	-----------

Rope

HAR:MANILA-ROPE	1/4" MANILA ROPE..1200'	\$ 75.89
-----------------	-------------------------	----------

SERVICE STATION HARDWARE

Fuel Hoses

GNH:9FT-HOSE	3/4" X 9' SOFT WALL FUEL HOSE..1 EACH	\$ 22.31
GNH:10FT-HOSE	3/4" X 10' SOFT WALL GAS HOSE..1 EACH ..	\$ 36.50
GNH:12FT-HOSE	3/4" X 12' SOFT WALL FUEL HOSE..1 EACH	\$ 50.90
GNH:3/4x14FT-HOSE	3/4" X 14' SOFT WALL FUEL HOSE..1 EACH	\$ 57.03
GNH:1X10FT-HOSE	1" X 10' SOFT WALL FUEL HOSE..1 EACH	\$ 79.16
GNH:1X12FT-HOSE	1" X 12' SOFT WALL FUEL HOSE..1 EACH	\$ 94.99
GNH:1X17FT-HOSE	1" X 17' SOFT WALL FUEL HOSE..1 EACH	\$ 157.61

Fuel Nozzles

GNH:NOLEAD	BLACK UNLEADED FUEL NOZZLE..1 EACH	\$ 75.90
GNH:3/4-DNOZZLE	3/4" DIESEL FUEL NOZZLE..1 EACH	\$ 43.50
GNH:7H-NEW	DIESEL FUEL NOZZLE WITH CLIP..1 EACH	\$ 153.40
GNH:1290REBUILT	REBUILT HIGH VOLUME NOZZLE..1 EACH	\$ 198.95

Fuel Nozzle Repair Parts

GNH:NOZZLE-END	11A SPOUT ASSEMBLY..1 EACH	\$ 14.15
GNH:BUSHING	NOZZLE BUSHING..1 EACH	\$ 1.75

Fuel Hose Swivels and Break-Aways

GNH:0350	3/4" SWIVEL..1 EACH	\$ 30.15
GNH:0087	1" SWIVEL..1 EACH	\$ 65.11
GNH:2274	3/4" BREAK AWAY HOSE..1 EACH	\$ 21.59
GNH:2273	3/4" SINGLE USE BREAK AWAY..1 EACH	\$ 40.36
GNH:3360	3/4" REUSABLE BREAK AWAY..1 EACH	\$ 79.34
GNH:2277	1" BREAK AWAY HOSE..1 EACH	\$ 37.96
GNH:2276	1" REUSABLE BREAK AWAY..1 EACH	\$ 127.60
GNH:COUPLER	1" FUEL HOSE COUPLER..1 EACH	\$ 4.74

Gauge Sticks

GNH:12FT-STICK	12' GAUGE STICK..1 EACH	\$ 20.64
GNH:14FT-STICK	14' GAUGE STICK..1 EACH	\$ 20.25
GNH:16FT-STICK	16' GAUGE STICK..1 EACH	\$ 28.99
GNH:550G-STICK	550 GAL TANK GAUGE STICK..1 EACH	\$ 16.00

Gas And Water Finding Paste

GNH:WATER-PASTE	WATER FINDING PASTE..3OZ TUBE	\$ 8.99
GNH:GAS-PASTE	GAS PASTE..2.25OZ JAR	\$ 5.30

Fuel Tank Filters

GNH:260HS10	10 MICRON FUEL TANK FILTER..1 EACH	\$ 14.67
GNH:70010	10 MICRON FUEL TANK FILTER..1 EACH	\$ 10.00
GNH:70066	30 MICRON FUEL TANK FILTER..1 EACH	\$ 20.99
GNH:300HS30	30 MICRON FUEL TANK FILTER..1 EACH	\$ 9.05
GNH:800HS30	30 MICRON FUEL TANK FILTER..1 EACH	\$ 34.10



FOR 50+ YEARS,
PARKER
BROTHERS
HAS BEEN
SERVING ATLANTA.
THANK YOU FOR
YOUR CONTINUED
SUPPORT!!



HARDWARE



SERVICE STATION HARDWARE

Signal Bell And Accessories

MIL:802	DRIVEWAY SIGNAL CHIME..1 EACH	\$ 57.35
MIL:805	DRIVEWAY SIGNAL BELL..1 EACH	\$ 56.92
MIL:819	DRIVEWAY SIGNAL HOSE ANCHOR..1 EACH	\$ 78.43
GAT:27539	SIGNAL CALL AIR HOSE..3/8" X 50'	\$ 31.52
GAT:28681-50	SIGNAL CALL AIR HOSE..3/8" X 50'	\$ 25.20
GAT:28681	SIGNAL CALL AIR HOSE..3/8" X 100'	\$ 59.76

Windshield Service Items

WSS:8NY	WINDSHIELD SQUEEGEE WITH 20" HANDLE	\$ 5.12
WSS:808NY	SQUEEGEE HEAD ONLY	\$ 3.15
WSS:885	SQUEEGEE BUCKET WITH BRACKET	\$ 15.76
WSS:890	7" WINDSHIELD ICE SCRAPER	\$ 1.02

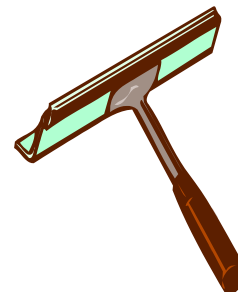

Gas Mitts

S/S:GAS-MITTS	GAS MITTS..1000 PER CASE	\$ 62.34
S/S:S/S14-0106	GAS MITT DISPENSER..1 EACH	\$ 56.03
S/S:14-0104	GAS MITTS INTRO KIT...1 BX GLOVES, DISP, HANGING HARWARE, & SIGN	\$ 109.49
S/S:14-0041	CITRUS WET WASH CLOTHS..12 CANS / 150 CLOTHS PER CAN	\$ 68.26
S/S:S/S14-0027	FRESHEN-UPS MOIST WIPES..70 WIPES PER CAN..1 CAN	\$ 3.91

Windshield Service Buckets

S/S:11-0312	SINGLE BUCKET WINDSHIELD SERVICE CENTER 1 EACH	\$ 164.93
S/S:11-0307	DOUBLE BUCKET WINDSHIELD SERVICE CENTER 1 EACH	\$ 187.90

Price Change Pole

S/S:16-0710	PRICE CHANGE POLE..1 EACG	\$ 83.25
-------------	---------------------------	----------



PARKER, BROTHERS, INC.

PARKER, BROTHERS, INC.

PARKER, BROTHERS, INC.

PARKER, BROTHERS, INC.

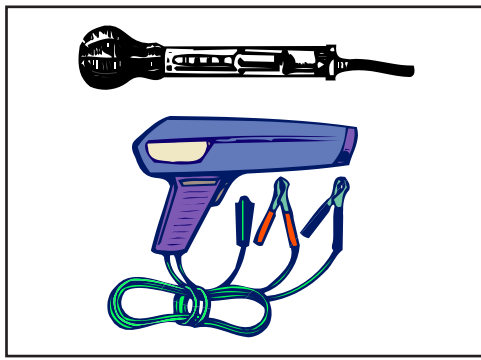

SHOP TOOLS

ELECTRICITY TOOLS
EXTENSION CORDS AND DROP LIGHTS
COMPRESSION TESTERS
ANTIFREEZE TESTERS
RAZOR BLADES
MISCELLANEOUS TOOLS

SHOP TOOLS



ELECTRICITY TOOLS

Milton Test Light

This 6 and 12 volt circuit tester features the MICRO-SHARP TIP for easy wire piercing, without damaging the wire. It leaves a virtually self sealing hole. Includes the illustrated Electrical Trouble-Shooters Guide.

MIL:S1232	6 AND 12 VOLT CIRCUIT TESTER..1 EACH	\$ 40.80
-----------	--------------------------------------	----------



S1232

Milton Current Indicator

Easily measure and check alternators, starter or generator current. Simply hold the instrument against the wire in the groove as indicated on the back of the case.

MIL:S1230	CURRENT INDICATOR..1 EACH	\$ 6.18
-----------	---------------------------	---------



Milton Battery-Starter-Charging System Tester

Rated up to 1000 cold cranking amps (cca). Heavy duty clips and 4 gauge wire. Battery testing : load test 6 and 12 volt auto and truck batteries. Starter testing : fast test for excessive current draw. Charging system test : easy overall check of the charging system.

MIL:1260	BATTERY / STARTER / CHARGING SYSTEM TESTER..1 EACH	\$ 85.72
MIL:1261	CARTRIDGE METER FOR 1260..1 EACH	\$ 40.04



S1230

Other Brands

BAT:ES700	6/12 VOLT ANALOG BATTERY/LOAD TESTER..1 EACH	\$ 48.80
BAT:CP7612	6/12 VOLT BATTERY LOAD TESTER..1 EACH	\$ 61.80

Battery Hydrometer

THX:115	BATTERY TESTER..1 EACH	\$ 4.85
THX:117	LARGE BATTERY TESTER..1 EACH	\$ 14.59

Battery Booster Cables

DEL:MT220	2 GA 20' 500 AMP BATTERY JUMPER CABLES	\$ 93.25
DEL:MT225	2 GA 25' 500 AMP BATTERY JUMPER CABLES	\$ 107.98
DEL:MT412	4 GA 12' 500 AMP BATTERY JUMPER CABLES	\$ 50.35
DEL:MT416	4 GA 16' 500 AMP BATTERY JUMPER CABLES	\$ 62.35
DEL:MT420	4 GA 20' 500 AMP BATTERY JUMPER CABLES	\$ 69.99
DEL:1426	500 AMP BATTERY CLAMP..2 PER BAG	\$ 10.30
DEL:PTWCLMP	500 AMP PARROT CLAMPS..2 PER BAG	\$ 6.22
DEL:1463	1 15/16" ALLIGATOR CLIP..4 PER BAG	\$ 3.99
DEL:1465	1 15/16" ALLIGATOR CLIP..100 PER BAG	\$ 74.49

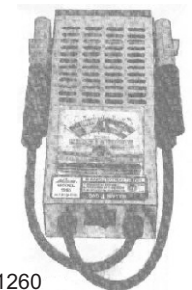

1260

Battery Booster Pack

BAT:PRO660	BLUE JUMP N CARRY JUMP BOX..1 EACH	\$ 215.22
------------	------------------------------------	-----------

Battery Charger

BAT:1014	BATTERY CHARGER..1 EACH	\$ 64.28
BAT:1014S	6/12 VOLT 10/2 AMP BATTERY CHARGER..1 EACH	\$ 62.34

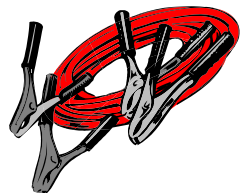

Fuse Tools

FUS:097023BP	TRI-PULLER FUSE PULLER	\$ 1.29
FUS:097019BP	AUTO FUSE TESTER/PULLER	\$ 8.99

EXTENSION CORDS AND DROP LIGHTS

Extension Cords

DEL:SL725	16 GA 3 WIRE 25' EXTENSION CORD	\$ 13.95
DEL:SL750	16 GA 3 WIRE 50' EXTENSION CORD	\$ 29.32
DEL:SL751	16 GA 3 WIRE 100' EXTENSION CORD	\$ 24.36
ALE:7262-A	50' ELECTRICAL CORD ON A REEL..1 EACH	\$ 41.54

Drop Lights

DEL:SL425	18 GA 3 WIRE 25' DROP LIGHT WITH METAL CAGE	\$ 15.98
DEL:SL426	18 GA 3 WIRE 50' DROP LIGHT WITH METAL CAGE	\$ 23.78
DEL:SL412	20' 12 VOLT DROP LIGHT..1 EACH	\$ 10.39
ALE:7262-B	50' DROP LIGHT ON A REEL ..1 EACH	\$ 65.00

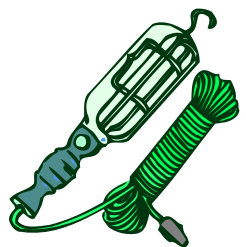

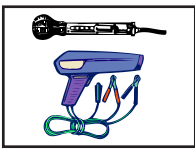

SHOP TOOLS

COMPRESSION TESTERS

Milton Engine Compression Tester And Accessories

Double fiber braided neoprene hydraulic hose. Includes 14 mm long range adapter and square valve core. Composite metric scale reads both PSI and all metric ranges. 0-300 PSI -- 0-21 kg/cm2. 0-2100 kPa -- 0-21 bars

MIL:S1251	DELUXE COMPRESSION TESTER..1 EACH	\$ 6.84
MIL:1251-2	REPLACEMENT VALVE CORE FOR S1251..1 EACH	\$ 1.15

Milton Diesel Engine Compression Tester And Accessories

Measures cylinder pressure on diesel equipped cars and trucks. "Kwik-Change" coupler permits fast threading in to hard to reach openings. The release valve allows for instant venting and resets the gauge for repeat checks. High pressure, hydraulic wire reinforced flexible hose. Composite metric scale reads both PSI and all metric ranges. 0-1000 PSI -- 0-70 kg/cm2. 0-7000 kPa -- 0-70 bars.

MIL:1255	DIESEL COMPRESSION TESTER..1 EACH	\$ 70.53
----------	-----------------------------------	----------

ANTIFREEZE TESTERS

Antifreeze Testers

ANT:W1655C	5-BALL ANTIFREEZE TESTER..1 EACH	\$ 0.96
ANT:W1656C	DELUXE ANTI-FREEZE TESTER..1 EACH	\$ 3.12
THX:102	ANTIFREEZE TESTER..1 EACH	\$ 6.99
THX:106	LARGE ANTI FREEZE TESTER..1 EACH	\$ 14.59
THX:W1656-C	DELUXE ANTI FREEZE TESTER..1 EACH	\$ 2.60
THX:101	HOT & COLD ANTI FREEZE TESTER..1 EACH	\$ 4.69
THX:100	PROPYLENE GLYCOL ANTI FREEZE TESTER..1 EACH	\$ 6.88

RAZOR BLADES

Cutters

HAR:NO12	NUMBER 12 RAZOR BLADE..100 PER BOX	\$ 6.07
HAR:NO9	NUMBER 9 RAZOR BLADES..100 PER BOX	\$ 5.23

MISCELLANEOUS TOOLS

Oil Filter Wrench

N/S:45	CHAIN TYPE FILTER WRENCH..1 EACH	\$ 3.94
--------	----------------------------------	---------

Car Ramps

G/C:11904	RHINO CAR RAMPS..1 SET	\$ 38.93
-----------	------------------------	----------

Grease Fitting Tool

ALE:B315790	EASY-OUT FITTING TOOL..1 EACH	\$ 22.45
-------------	-------------------------------	----------

Screwdriver Set

PRI:W904	8 PIECE ORANGE SCREWDRIVER	\$ 10.35
----------	----------------------------	----------

Air Tank

PRI:W10011	11 GALLON AIR TANK..1 EACH	\$ 69.75
------------	----------------------------	----------

12 Volt Air Compressor

PRI:HD300	300 PSI 12 VOLT AIR COMPRESSOR..1 EACH	\$ 52.02
-----------	--	----------

Floor Jack

SWC:JACK	3 1/2 TON FLOOR JACK..1 EACH	\$ 175.00
----------	------------------------------	-----------

Terminal Crimping Tool

DEL:990000	DIE CAST TERMINAL CRIMPING TOOL..1 EACH	\$ 215.00
------------	---	-----------

Mirrors

PRI:W1911	SMALL TELESCOPING MIRROR..1 EACH	\$ 2.50
SAF:SEK002	26" CONVEX MIRROR WITH MOUNTING BRACKETS..1 EACH	\$ 62.93

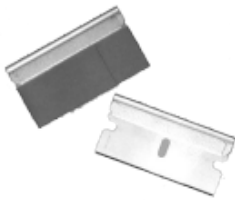

SHOP TOOLS



MISCELLANEOUS TOOLS

Brake Lathe Bits

TMR:CB 69 14-10	AMMCO STYLE BRAKE LATHE BIT ..10 PER PACK	\$ 25.55
-----------------	---	----------

Ferrule Crimping Tool

This tool makes professional quality hose assemblies fast and easy. Crimps ferrules on hoses ranging from 1/4" single braid to 3/8" two braid hose. Made of high strength ductile iron casting has 5 hardened steel ribbed dies ready for instant use. Can be bench mounted or used as a portable tool at the job site.

M IL:1626	HOSE FERRULE CRIMPING TOOL..1 EACH	\$ 141.05
-----------	------------------------------------	-----------

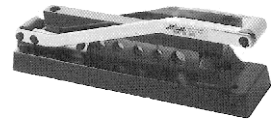

1626

Tubing Cutter

Light weight and easy to use plastic tube cutter. Blade design guarantees clean edge cut without deforming tube. Built in blade guard helps protect user Blades easily replaced. To cut nylon, polyethylene, polyurethane, and PUREX tubing 1/8"OD through 3/4"OD tube. WARNING : blade extremely sharp, use caution. Keep out of reach of children.

M IL:1690	TUBING CUTTER..1 EACH	\$ 7.16
-----------	-----------------------	---------

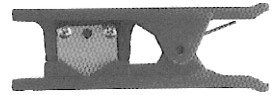

1690



MONDAY-FRIDAY
8am-5pm a helpful
HUMAN voice will
always answer the
phone
(770)474-1286

Parker Brothers
gladly accepts
Visa, Mastercard
Discover &
American Express

FOR 50 YEARS,
PARKER
BROTHERS
HAS BEEN
SERVING ATLANTA.
THANK YOU FOR
YOUR CONTINUED
SUPPORT!!

PARKER, BROTHERS, INC.

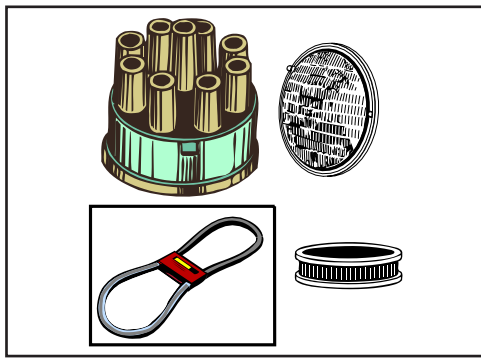

AUTOMOTIVE PARTS

HOSE CLAMPS
FLASHERS
WINDSHIELD WIPERS
GREASE FITTINGS
BULBS
SPARK PLUGS
FILTERS
BALDWIN FILTERS
GATES PRODUCTS
STANT THERMOSTATS AND CAPS
MUFFLER CLAMPS
BATTERIES
DRAIN PLUGS AND GASKETS
SMALL PARTS ASSORTMENTS

AUTOMOTIVE PARTS

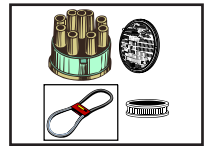

HOSE CLAMPS

Worm Gear Hose Clamps

H/C:SC4	1/4" - 5/8" HOSE CLAMPS..10 PER BOX	\$ 4.50
H/C:SC6	5/16" - 7/8" HOSE CLAMPS..10 PER BOX	\$ 4.50
H/C:CC8	7/16" - 1" HOSE CLAMPS..10 PER BOX	\$ 3.95
H/C:CC10	1/2" - 1 1/8" HOSE CLAMP..10 PER BOX	\$ 3.95
H/C:CC12	1/2" - 1 1/4" HOSE CLAMP..10 PER BOX	\$ 3.95
H/C:CC16	3/4" - 1 1/2" HOSE CLAMPS..10 PER BOX	\$ 3.95
H/C:CC20	3/4" - 1 3/4" HOSE CLAMPS..10 PER BOX	\$ 4.66
H/C:CC24	1" - 2" HOSE CLAMPS..10 PER BOX	\$ 4.23
H/C:CC28	1 5/16" - 2 1/4" HOSE CLAMPS..10 PER BOX	\$ 4.23
H/C:CC32	1 9/16" - 2 1/4" HOSE CLAMPS..10 PER BOX	\$ 3.95
H/C:CC36	1 7/8" - 2 3/4" HOSE CLAMPS..10 PER BOX	\$ 6.88
H/C:40B	1 1/8" - 3" HOSE CLAMPS..10 PER BOX	\$ 7.54
H/C:44B	2 5/16" - 3 1/4" HOSE CLAMPS..10 PER BOX	\$ 7.48
H/C:48B	2 5/8" - 3 1/2" HOSE CLAMPS..10 PER BOX	\$ 7.72
H/C:72B	2 1/8" - 5" HOSE CLAMPS..10 PER BOX	\$ 7.41
H/C:104	5" - 7" HOSE CLAMPS..10 PER BOX	\$ 6.15
H/C:150-044	9/16" WIDE 2 5/16" - 3 1/4" HOSE CLAMP..10 PER BOX	\$ 6.23
H/C:150-048	9/16" WIDE 1 1/2" - 2 3/4" HOSE CLAMP..10 PER BOX	\$ 7.49
H/C:150-064	9/16" WIDE 2 1/2" - 4 1/2" HOSE CLAMP..10 PER BOX	\$ 6.82
H/C:150-072	9/16" WIDE 2 1/8" - 5" HOSE CLAMP..10 PER BOX	\$ 10.24
H/C:150-104	9/16" WIDE 5" - 7" HOSE CLAMP..10 PER BOX	\$ 11.02

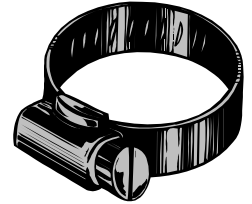
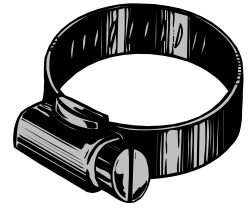

Fuel Injection Hose Clamps

H/C:905-004	1/4" FUEL INJECTION HOSE CLAMP..10 PER BOX	\$ 8.85
H/C:905-006	5/16" FUEL INJECTION HOSE CLAMP..10 PER BOX	\$ 8.85
H/C:905-008	3/8" FUEL INJECTION HOSE CLAMP..10 PER BOX	\$ 8.85

Hose Clamp Rack

H/C:LEGION-RACK	LEGION HOSE CLAMP RACK..1 EACH	\$ 11.50
H/C:RACK	HOSE CLAMP RACK..1 EACH	\$ 17.17
H/C:19901	METAL HOSE CLAMP RACK..1 EACH	\$ 55.12

FLASHERS

Flashers

These two terminal flashers are the most popular flashers in domestic cars. They run 12 volt systems for turn signals, flashing two or three 32 C.P. standard or long life bulbs, and hazard warnings, flashing two to six lamps.

H/C:536	2 PRONG HEAVY DUTY FLASHER	\$ 4.98
H/C:552	2 PRONG HEAVY DUTY FLASHER	\$ 2.76

These three terminal flashers are for import cars and domestic trucks. They run 12 volt systems for turn signals, flashing two or three 32 C.P. standard or long life bulbs, and hazard warnings, flashing two to six lamps.

H/C:550	3 PRONG HEAVY DUTY FLASHER	\$ 1.94
---------	----------------------------	---------

These three terminal flashers are for cars and light trucks. They run 12 volt systems for turn signals, flashing two or three 32 C.P. standard or long life bulbs, and hazard warnings, flashing two to six lamps.

H/C:568	3 PRONG HEAVY DUTY FLASHER	\$ 2.28
H/C:569	3 PRONG HEAVY DUTY FLASHER	\$ 2.81

These heavy duty flashers are for heavy equipment and vehicles with many accessory lights (i.e. police cars, fire trucks, etc.).

H/C:EF32	2 PRONG EXTRA HEAVY DUTY FLASHER	\$ 7.25
H/C:EL13	3 PRONG HEAVY DUTY FLASHER	\$ 6.11



PARKER, BROTHERS, INC.

AUTOMOTIVE PARTS

WINDSHIELD WIPERS

Anco Aerovantage Blades

These premium wiper blades are designed with long aerodynamic frames and feature the easy Kwik Connect installation system.

ANC:91-12	AEROVANTAGE WIPER BLADE..1 EACH	\$ 5.99
ANC:91-13	AEROVANTAGE WIPER BLADE..1 EACH	\$ 5.99
ANC:91-14	AEROVANTAGE WIPER BLADE..1 EACH	\$ 5.99
ANC:91-15	AEROVANTAGE WIPER BLADE..1 EACH	\$ 5.99
ANC:91-16	AEROVANTAGE WIPER BLADE..1 EACH	\$ 5.99
ANC:91-17	AEROVANTAGE WIPER BLADE..1 EACH	\$ 5.99
ANC:91-18	AEROVANTAGE WIPER BLADE..1 EACH	\$ 5.99
ANC:91-19	AEROVANTAGE WIPER BLADE..1 EACH	\$ 5.99
ANC:91-20	AEROVANTAGE WIPER BLADE..1 EACH	\$ 5.99
ANC:91-21	AEROVANTAGE WIPER BLADE..1 EACH	\$ 5.99
ANC:91-22	AEROVANTAGE WIPER BLADE..1 EACH	\$ 5.99
ANC:91-24	AEROVANTAGE WIPER BLADE..1 EACH	\$ 5.99
ANC:91-26	AEROVANTAGE WIPER BLADE..1 EACH	\$ 5.99
ANC:91-28	AEROVANTAGE WIPER BLADE..1 EACH	\$ 5.99

Anco Premium Blades

These premium wiper blades are designed with long frames and feature the easy Kwik Connect installation system. They also have end tab removal inserts.

ANC:31-12	KWIK CONNECT WIPER BLADE..1 EACH	\$ 4.95
ANC:31-13	KWIK CONNECT WIPER BLADE..1 EACH	\$ 4.95
ANC:31-14	KWIK CONNECT WIPER BLADE..1 EACH	\$ 4.95
ANC:31-15	KWIK CONNECT WIPER BLADE..1 EACH	\$ 4.95
ANC:31-16	KWIK CONNECT WIPER BLADE..1 EACH	\$ 4.95
ANC:31-17	KWIK CONNECT WIPER BLADE..1 EACH	\$ 4.95
ANC:31-18	KWIK CONNECT WIPER BLADE..1 EACH	\$ 4.95
ANC:31-19	KWIK CONNECT WIPER BLADE..1 EACH	\$ 4.95
ANC:31-20	KWIK CONNECT WIPER BLADE..1 EACH	\$ 4.95
ANC:31-21	KWIK CONNECT WIPER BLADE..1 EACH	\$ 4.95
ANC:31-22	KWIK CONNECT WIPER BLADE..1 EACH	\$ 4.95
ANC:31-24	KWIK CONNECT WIPER BLADE..1 EACH	\$ 4.95
ANC:31-26	KWIK CONNECT WIPER BLADE..1 EACH	\$ 4.95
ANC:31-28	KWIK CONNECT WIPER BLADE..1 EACH	\$ 4.95

Anco Contour Blades

These premium wiper blades are designed with long frames and feature the easy Kwik Connect installation system. They also are curved to keep better contact with the windshield.

ANC:C16UB	CONTOUR WIPER BLADES..1 EACH	\$ 19.28
ANC:C18UB	CONTOUR WIPER BLADES..1 EACH	\$ 15.45
ANC:C19UB	CONTOUR WIPER BLADES..1 EACH	\$ 14.46
ANC:C20UB	CONTOUR WIPER BLADES..1 EACH	\$ 15.92
ANC:C21BB	CONTOUR WIPER BLADES..1 EACH	\$ 15.92
ANC:C220E	CONTOUR WIPER BLADES..1 EACH	\$ 12.62
ANC:C22UB	CONTOUR WIPER BLADES..1 EACH	\$ 22.00
ANC:C24BB	CONTOUR WIPER BLADES..1 EACH	\$ 18.09
ANC:C24UB	CONTOUR WIPER BLADES..1 EACH	\$ 18.09
ANC:C26UB	CONTOUR WIPER BLADES..1 EACH	\$ 18.87

Other Anco Blades

ANC:20-11	WIPER BLADE..1 EACH	\$ 7.07
ANC:20-12	WIPER BLADE..1 EACH	\$ 7.07
ANC:22-20	WIPER BLADE..1 EACH	\$ 6.80
ANC:22-24	WIPER BLADE..1 EACH	\$ 12.53
ANC:25-11	WIPER BLADE..1 EACH	\$ 5.43
ANC:25-12	WIPER BLADE..1 EACH	\$ 5.43
ANC:25-13	WIPER BLADE..1 EACH	\$ 5.24
ANC:25-14	WIPER BLADE..1 EACH	\$ 5.43
ANC:29-16	WIPER BLADE..1 EACH	\$ 6.37
ANC:29-18	WIPER BLADE..1 EACH	\$ 6.37
ANC:29-20	WIPER BLADE..1 EACH	\$ 8.89
ANC:30-18	WIPER BLADE..1 EACH	\$ 6.21
ANC:51-13	HEAVY DUTY FLAT WIPER BLADE..1 EACH	\$ 5.34
ANC:51-14	HEAVY DUTY FLAT WIPER BLADE..1 EACH	\$ 5.34
ANC:51-15	HEAVY DUTY FLAT WIPER BLADE..1 EACH	\$ 5.34
ANC:51-16	HEAVY DUTY FLAT WIPER BLADE..1 EACH	\$ 5.13



AUTOMOTIVE PARTS

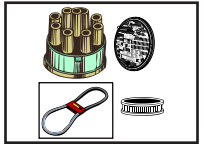

WINDSHIELD WIPERS

Other Anco Blades

ANC:51-17	HEAVY DUTY FLAT WIPER BLADE..1 EACH	\$ 5.34
ANC:51-18	HEAVY DUTY FLAT WIPER BLADE..1 EACH	\$ 5.49
ANC:51-20	HEAVY DUTY FLAT WIPER BLADE..1 EACH	\$ 5.79
ANC:51-22	HEAVY DUTY FLAT WIPER BLADE..1 EACH	\$ 5.75
ANC:52-14	HEAVY DUTY CURVED WIPER BLADE..1 EACH	\$ 7.81
ANC:52-15	HEAVY DUTY CURVED WIPER BLADE..1 EACH	\$ 9.10
ANC:52-16	HEAVY DUTY CURVED WIPER BLADE..1 EACH	\$ 7.47
ANC:52-18	HEAVY DUTY CURVED WIPER BLADE..1 EACH	\$ 8.97
ANC:52-20	HEAVY DUTY CURVED WIPER BLADE..1 EACH	\$ 7.76
ANC:52-26	HEAVY DUTY CURVED WIPER BLADE..1 EACH	\$ 32.18
ANC:52-28	HEAVY DUTY CURVED WIPER BLADE..1 EACH	\$ 10.02
ANC:57-01	HEAVY DUTY WIPER BLADE..1 EACH	\$ 9.63
ANC:57-03	HEAVY DUTY WIPER BLADE..1 EACH	\$ 27.62
ANC:57-14	HEAVY DUTY WIPER BLADE..1 EACH	\$ 28.51
ANC:57-18	HEAVY DUTY WIPER BLADE..1 EACH	\$ 10.20
ANC:57-26	HEAVY DUTY WIPER BLADE..1 EACH	\$ 5.38
ANC:57-40	HEAVY DUTY WIPER BLADE..1 EACH	\$ 10.55
ANC:P 16B	PLASTIC WIPER BLADE..1 EACH	\$ 6.33
ANC:P 18B	PLASTIC WIPER BLADE..1 EACH	\$ 6.33



Anco Wiper Refills

ANC:11-14	WIPER REFILL..1 PAIR	\$ 3.50
ANC:11-15	WIPER REFILL..1 PAIR	\$ 3.50
ANC:11-16	WIPER REFILL..1 PAIR	\$ 3.50
ANC:11-17	WIPER REFILL..1 PAIR	\$ 3.50
ANC:11-18	WIPER REFILL..1 PAIR	\$ 3.50
ANC:11-19	WIPER REFILL..1 PAIR	\$ 3.50
ANC:11-20	WIPER REFILL..1 PAIR	\$ 3.50
ANC:11-21	WIPER REFILL..1 PAIR	\$ 3.50
ANC:11-22	WIPER REFILL..1 PAIR	\$ 3.50
ANC:11-24	WIPER REFILL..1 PAIR	\$ 3.50
ANC:12-11	WIPER REFILL..1 PAIR	\$ 5.43
ANC:13-19	WIPER REFILL..1 PAIR	\$ 5.36
ANC:16-16	WIPER REFILL..1 PAIR	\$ 5.76
ANC:16-18	WIPER REFILL..1 PAIR	\$ 5.76
ANC:19-16	WIPER REFILL..1 PAIR	\$ 5.76
ANC:19-17	WIPER REFILL..1 PAIR	\$ 5.76
ANC:19-18	WIPER REFILL..1 PAIR	\$ 5.34
ANC:19-19	WIPER REFILL..1 PAIR	\$ 5.43
ANC:19-20	WIPER REFILL..1 PAIR	\$ 5.80
ANC:19-21	WIPER REFILL..1 PAIR	\$ 5.71
ANC:19-22	WIPER REFILL..1 PAIR	\$ 5.80
ANC:19-24	WIPER REFILL..1 PAIR	\$ 5.95
ANC:19-28	WIPER REFILL..1 PAIR	\$ 7.57
ANC:53-15	HEAVY DUTY WIPER REFILL..1 EACH	\$ 4.69
ANC:53-16	HEAVY DUTY WIPER REFILL..1 EACH	\$ 4.49
ANC:53-18	HEAVY DUTY WIPER REFILL..1 EACH	\$ 4.49
ANC:53-20	HEAVY DUTY WIPER REFILL..1 EACH	\$ 4.49
ANC:55-18	CURVED WIPER REFILL..1 EACH	\$ 12.68
ANC:56-14	CURVED WIPER REFILL..1 EACH	\$ 6.93
ANC:58-18	WIPER REFILL..1 EACH	\$ 4.69
ANC:N 16R	WIPER REFILL - IMPORT..1 PAIR	\$ 4.59
ANC:N 17R	WIPER REFILL - IMPORT..1 PAIR	\$ 4.66
ANC:N 18R	WIPER REFILL - IMPORT..1 PAIR	\$ 4.59
ANC:N 19R	WIPER REFILL - IMPORT..1 PAIR	\$ 4.82
ANC:N 20R	WIPER REFILL - IMPORT..1 PAIR	\$ 4.82
ANC:N 21R	WIPER REFILL - IMPORT..1 PAIR	\$ 4.82
ANC:N 22R	WIPER REFILL - IMPORT..1 PAIR	\$ 4.82
ANC:N 24R	WIPER REFILL - IMPORT..1 PAIR	\$ 5.14
ANC:T 20R	WIPER REFILL..1 PAIR	\$ 4.76
ANC:U 15R	WIPER REFILL..1 PAIR	\$ 4.99
ANC:U 16R	WIPER REFILL..1 PAIR	\$ 4.82
ANC:U 17R	WIPER REFILL..1 PAIR	\$ 4.82
ANC:U 18R	WIPER REFILL..1 PAIR	\$ 4.82
ANC:U 19R	WIPER REFILL..1 PAIR	\$ 4.82



WINDSHIELD WIPERS

Anco Wiper Refills

ANC:U20R	WIPER REFILL..1 PAIR	\$ 4.89
ANC:U21R	WIPER REFILL..1 PAIR	\$ 5.06
ANC:U22R	WIPER REFILL..1 PAIR	\$ 4.89
ANC:U24R	WIPER REFILL..1 PAIR	\$ 5.19
ANC:W20R	WIPER REFILL..1 PAIR	\$ 4.82
ANC:W21R	WIPER REFILL..1 PAIR	\$ 4.82
ANC:W22R	WIPER REFILL..1 PAIR	\$ 4.82
ANC:W24R	WIPER REFILL..1 PAIR	\$ 5.33
ANC:W28R	WIPER REFILL..1 PAIR	\$ 7.07

Anco Assortments

Roll around merchandiser. It holds 100 blades or 140 refills. It ships without product.

ANC:97894	RETAILER MOBIL DISPLAY CENTER..1 EACH	\$ 126.04
-----------	---------------------------------------	-----------

This is a stationary peg board display. It holds 60 blades or 90 refills. It ships without product.

ANC:06070	2 TIER WALL MOUNT DISPLAY ..1 EACH	\$ 33.50
-----------	------------------------------------	----------

Anco Wiper arms

ANC:41-02	ADJUSTABLE WIPER ARM ..1 EACH	\$ 12.45
ANC:41-03	ADJUSTABLE WIPER ARM ..1 EACH	\$ 12.45
ANC:43-30	WIPER ARM ..1 EACH	\$ 16.75
ANC:43-31	WIPER ARM ..1 EACH	\$ 16.75
ANC:44-05	ADJUSTABLE WIPER ARM ..1 EACH	\$ 13.15
ANC:44-06	ADJUSTABLE WIPER ARM ..1 EACH	\$ 13.15
ANC:45-52	HEAVY DUTY WIPER ARM ..1 EACH	\$ 19.66
ANC:45-53	HEAVY DUTY WIPER ARM ..1 EACH	\$ 20.45
ANC:45-80	HEAVY DUTY WIPER ARM ..1 EACH	\$ 24.71

Anco Washer Pumps

ANC:61-16	WASHER PUMP ..1 EACH	\$ 28.54
ANC:61-18	WASHER PUMP ..1 EACH	\$ 17.82
ANC:62-01	WASHER PUMP ..1 EACH	\$ 13.95
ANC:64-01	WASHER PUMP ..1 EACH	\$ 17.91
ANC:65-01	WASHER PUMP ..1 EACH	\$ 14.62
ANC:66-01	WASHER PUMP ..1 EACH	\$ 36.55

Premium Vision Wiper Blades

Blades have metal arms and spine blades. Complete with all needed adapters. 10 numbers provide coverage.

POF:PB13P	PREMIUM GUARD WIPER BLADES..10 PER BOX	\$ 19.00
POF:PB15P	PREMIUM GUARD WIPER BLADES..10 PER BOX	\$ 19.00
POF:PB16P	PREMIUM GUARD WIPER BLADES..10 PER BOX	\$ 19.00
POF:PB17P	PREMIUM GUARD WIPER BLADES..10 PER BOX	\$ 24.00
POF:PB18P	PREMIUM GUARD WIPER BLADES..10 PER BOX	\$ 24.00
POF:PB19P	PREMIUM GUARD WIPER BLADES..10 PER BOX	\$ 22.43
POF:PB20P	PREMIUM GUARD WIPER BLADES..10 PER BOX	\$ 26.50
POF:PB21P	PREMIUM GUARD WIPER BLADES..10 PER BOX	\$ 26.50
POF:PB22P	PREMIUM GUARD WIPER BLADES..10 PER BOX	\$ 26.50
POF:PB24P	PREMIUM GUARD WIPER BLADES..10 PER BOX	\$ 26.50
POF:PB26P	PREMIUM GUARD WIPER BLADES..10 PER BOX	\$ 29.50
POF:PB28P	PREMIUM GUARD WIPER BLADES..10 PER BOX	\$ 36.50
POF:WIPER-DISPLAY	WIPER DISPLAY	\$ 31.00

GREASE FITTINGS

Grease Fittings

G/F:1607	1/8" NPT LONG STRAIGHT GREASE FITTING	\$ 0.55
G/F:1608	5/16" DRIVE IN STRAIGHT GREASE FITTING	\$ 0.25
G/F:1610	1/8" NPT SHORT STRAIGHT GREASE FITTING	\$ 0.48
G/F:1611	1/8" NPT 30 DEGREE GREASE FITTING	\$ 0.33
G/F:1612	1/8" NPT 65 DEGREE GREASE FITTING	\$ 0.40
G/F:1613	1/8" NPT 90 DEGREE GREASE FITTING	\$ 0.51
G/F:1626	1/4" NPT STRAIGHT GREASE FITTING	\$ 0.71
G/F:1627	1/4" NPT STRAIGHT GREASE FITTING	\$ 0.71
G/F:1629	1/4" NPT 65 DEGREE GREASE FITTING	\$ 0.05
G/F:1637	1/4"-28 SHORT 45 DEGREE GREASE FITTING	\$ 0.35
G/F:1641	1/4"-28 SHORT STRAIGHT GREASE FITTING	\$ 0.15
G/F:1645	6MM X 145 DEGREE GREASE FITTING	\$ 0.68



FOR 50+ YEARS,
PARKER
BROTHERS
HAS BEEN
SERVING ATLANTA.
**THANK YOU FOR
YOUR CONTINUED
SUPPORT!!**





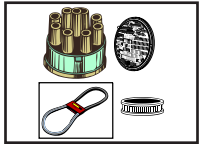





AUTOMOTIVE PARTS





GREASE FITTINGS



1/4-28 Taper Thread

Size	Price Per 100
	#1641 Short Straight
1/4" - 28	
	#1652 Long Straight
1/4" - 28	
	#1680 Extra Long Straight
1/4" - 28	
	#1637 Short 45° Elbow
1/4" - 28	
	#1636 Long 45° Elbow
1/4" - 28	
	#1911 90° Elbow
1/4" - 28	
1/8 Pipe Thread	
	#1610 Short Straight
1/8"	
	#1607 Long Straight
1/4"	
	#1611 30° Elbow
1/8"	





1/8 Pipe Thread

Size	Price Per 100
	#1688 45° Elbow
1/8"	
	#1612 65° Elbow
1/8"	
	#1613 90° Elbow
1/8"	









1/4 Pipe Thread

	#1627 Straight
1/4"	
	#1629 65° Elbow
1/4"	

Drive Type

	#1608 Straight
5/16"	
	#1699 No Ball Straight
5/16"	
Size	Price Per 100
	#1728 Straight
3/16"	
	#1743 Straight
1/4"	

Metric

Size	Price Per 100
	#860 Straight
8MM x 1	
	#704 45° Elbow
8MM x 1	
	#709 90° Elbow
8MM x 1	
	#890 Straight
8MM x 1	
	#744 45° Elbow
8MM x 1	52.94
	#749 90° Elbow
8MM x 1	
	#930 Straight
10mm x 1	
	#784 45° Elbow
10mm x 1	
	#789 90° Elbow
10mm x 1	



AUTOMOTIVE PARTS

MONDAY-FRIDAY
8am-5pm a helpful
HUMAN voice will
always answer the
phone
(770)474-1286

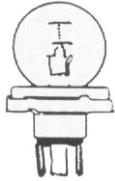

SYLVANIA

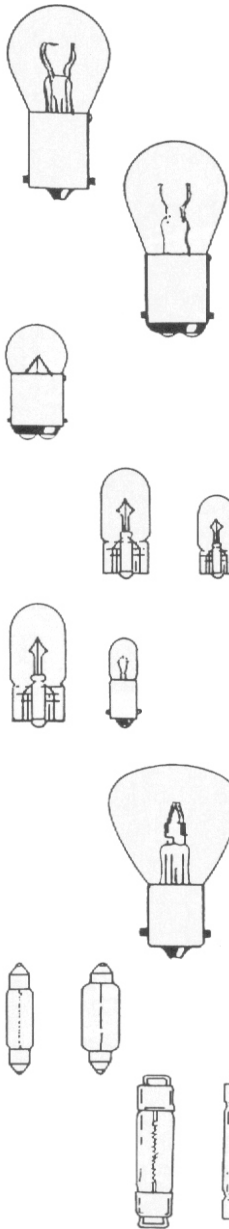

GREASE FITTINGS

Grease Fittings

G/F:1699	5/16" DRIVE IN STRAIGHT GREASE FITTING	\$ 0.25
G/F:1728	3/16" DRIVE IN STRAIGHT GREASE FITTING	\$ 0.16
G/F:1743	1/4" DRIVE IN STRAIGHT GREASE FITTING	\$ 0.19
G/F:1866	10MM X 145 DEGREE GREASE FITTING	\$ 0.38
G/F:1890	10MM X 190 DEGREE GREASE FITTING	\$ 0.38
G/F:1896	1/4"-28 STRAIGHT GREASE FITTING	\$ 0.20
G/F:1911	1/4"-28 90 DEGREE GREASE FITTING	\$ 0.44
G/F:613	1/8" NPT 90 DEGREE GREASE FITTING	\$ 0.32
G/F:641	1/4"-28 SHORT STRAIGHT GREASE FITTING	\$ 0.15
G/F:704	6MM X 145 DEGREE GREASE FITTING	\$ 0.35
G/F:709	6MM X 190 DEGREE GREASE FITTING	\$ 0.35
G/F:749	8MM X 190 DEGREE GREASE FITTING	\$ 0.40
G/F:784	10MM X 145 DEGREE GREASE FITTING	\$ 0.40
G/F:789	10MM X 190 DEGREE GREASE FITTING	\$ 0.40
G/F:860	6MM X 1 STRAIGHT GREASE FITTING	\$ 0.56
G/F:890	8MM X 1 STRAIGHT GREASE FITTING	\$ 0.20
G/F:930	10MM X 1 STRAIGHT GREASE FITTING	\$ 0.25
N/S:62X	1/4 NPT STRAIGHT GREASE FITTINGS..100 PER BOX	\$ 55.58

Grease Fitting Assortment

N/S:66	STANDARD GREASE FITTINGS..6 SIZES - 80 PIECES..1 ASSORTMENT	\$ 27.61
--------	---	----------

BULBS

Sylvania Miniature Bulbs

SYL:24	MINIATURE LAMPS..10 PER BOX	\$ 4.74
SYL:24NA	MINIATURE LAMPS..10 PER BOX	\$ 5.64
SYL:37	MINIATURE LAMPS..10 PER BOX	\$ 3.69
SYL:53	MINIATURE LAMPS..10 PER BOX	\$ 3.69
SYL:55	MINIATURE LAMPS..10 PER BOX	\$ 3.15
SYL:56	MINIATURE LAMPS..10 PER BOX	\$ 4.05
SYL:57	MINIATURE LAMPS..10 PER BOX	\$ 3.69
SYL:63	MINIATURE LAMPS..10 PER BOX	\$ 3.69
SYL:67	MINIATURE LAMPS..10 PER BOX	\$ 3.69
SYL:68	MINIATURE LAMPS..10 PER BOX	\$ 3.69
SYL:70	MINIATURE LAMPS..10 PER BOX	\$ 7.35
SYL:73	MINIATURE LAMPS..10 PER BOX	\$ 3.60
SYL:74	MINIATURE LAMPS..10 PER BOX	\$ 4.95
SYL:89	MINIATURE LAMPS..10 PER BOX	\$ 3.69
SYL:90	MINIATURE LAMPS..10 PER BOX	\$ 3.39
SYL:93	MINIATURE LAMPS..10 PER BOX	\$ 8.86
SYL:94	MINIATURE LAMPS..10 PER BOX	\$ 10.77
SYL:97	MINIATURE LAMPS..10 PER BOX	\$ 3.69
SYL:98	MINIATURE LAMPS..10 PER BOX	\$ 5.87
SYL:158	MINIATURE LAMPS..10 PER BOX	\$ 3.69
SYL:161B	MINIATURE LAMPS..10 PER BOX	\$ 8.00
SYL:168	MINIATURE LAMPS..10 PER BOX	\$ 3.99
SYL:193	MINIATURE LAMPS..10 PER BOX	\$ 3.69
SYL:194	MINIATURE LAMPS..10 PER BOX	\$ 3.49
SYL:PC74	MINIATURE LAMPS..10 PER BOX	\$ 10.35
SYL:PC194	MINIATURE LAMPS..10 PER BOX	\$ 6.50
SYL:194LL	MINIATURE LAMPS..10 PER BOX	\$ 4.75
SYL:194NA	MINIATURE LAMPS..10 PER BOX	\$ 8.50
SYL:198	MINIATURE LAMPS..10 PER BOX	\$ 2.70
SYL:199	MINIATURE LAMPS..10 PER BOX	\$ 3.69
SYL:211-2	MINIATURE LAMPS..10 PER BOX	\$ 5.75
SYL:212-2	MINIATURE LAMPS..10 PER BOX	\$ 9.44
SYL:222	MINIATURE LAMPS..10 PER BOX	\$ 3.39
SYL:293	MINIATURE LAMPS..10 PER BOX	\$ 5.58
SYL:561	MINIATURE LAMPS..10 PER BOX	\$ 7.69
SYL:PC579	MINIATURE LAMPS..10 PER BOX	\$ 20.85
SYL:880BP	HALOGEN LAMP..1 EACH	\$ 3.75
SYL:880S	HALOGEN LAMP..1 EACH	\$ 7.68
SYL:881	HALOGEN LAMP..1 EACH	\$ 6.95
SYL:881BP	HALOGEN LAMP..1 EACH	\$ 4.95

(770)474-1286

14-6

AUTOMOTIVE PARTS

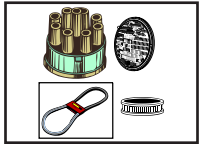

BULBS

Sylvania Miniature Bulbs

SYL:884	HALOGEN LAMP..1 EACH	\$ 3.00
SYL:885	HALOGEN LAMP..1 EACH	\$ 4.95
SYL:885BP	HALOGEN LAMP..1 EACH	\$ 4.95
SYL:886	HALOGEN LAMP..1 EACH	\$ 5.50
SYL:888	HALOGEN LAMP..1 EACH	\$ 3.00
SYL:889	HALOGEN LAMP..1 EACH	\$ 4.50
SYL:889BP	HALOGEN LAMP..1 EACH	\$ 4.95
SYL:891	HALOGEN LAMP..1 EACH	\$ 4.50
SYL:893BP	HALOGEN LAMP..1 EACH	\$ 4.95
SYL:894	HALOGEN LAMP..1 EACH	\$ 7.38
SYL:896	HALOGEN LAMP..1 EACH	\$ 2.50
SYL:899	HALOGEN LAMP..1 EACH	\$ 5.20
SYL:904	MINIATURE LAMPS..10 PER BOX	\$ 4.00
SYL:906	MINIATURE LAMPS..10 PER BOX	\$ 3.69
SYL:912	MINIATURE LAMPS..10 PER BOX	\$ 3.69
SYL:916	MINIATURE LAMPS..10 PER BOX	\$ 3.69
SYL:916NA	MINIATURE LAMPS..10 PER BOX	\$ 5.49
SYL:921	MINIATURE LAMPS..10 PER BOX	\$ 3.69
SYL:922	MINIATURE LAMPS..10 PER BOX	\$ 4.00
SYL:1003	MINIATURE LAMPS..10 PER BOX	\$ 3.69
SYL:1004	MINIATURE LAMPS..10 PER BOX	\$ 2.73
SYL:1034	MINIATURE LAMPS..10 PER BOX	\$ 2.94
SYL:1073	MINIATURE LAMPS..10 PER BOX	\$ 3.60
SYL:1076	MINIATURE LAMPS..10 PER BOX	\$ 3.60
SYL:1129	MINIATURE LAMPS..10 PER BOX	\$ 1.98
SYL:1141	MINIATURE LAMPS..10 PER BOX	\$ 3.69
SYL:1142	MINIATURE LAMPS..10 PER BOX	\$ 3.60
SYL:1154	MINIATURE LAMPS..10 PER BOX	\$ 4.50
SYL:1155	MINIATURE LAMPS..10 PER BOX	\$ 4.95
SYL:1156	MINIATURE LAMPS..10 PER BOX	\$ 3.69
SYL:1156DC	MINIATURE LAMPS..10 PER BOX	\$ 3.69
SYL:1156NA	MINIATURE LAMPS..10 PER BOX	\$ 6.95
SYL:1157	MINIATURE LAMPS..10 PER BOX	\$ 3.69
SYL:1157LL	MINIATURE LAMPS..10 PER BOX	\$ 8.10
SYL:1157NA	MINIATURE LAMPS..10 PER BOX	\$ 6.00
SYL:1176	MINIATURE LAMPS..10 PER BOX	\$ 4.50
SYL:1195	MINIATURE LAMPS..10 PER BOX	\$ 5.95
SYL:1445	MINIATURE LAMPS..10 PER BOX	\$ 3.69
SYL:1815	MINIATURE LAMPS..10 PER BOX	\$ 2.94
SYL:1816	MINIATURE LAMPS..10 PER BOX	\$ 2.94
SYL:1889	MINIATURE LAMPS..10 PER BOX	\$ 3.00
SYL:1891	MINIATURE LAMPS..10 PER BOX	\$ 3.15
SYL:1893	MINIATURE LAMPS..10 PER BOX	\$ 3.69
SYL:1895	MINIATURE LAMPS..10 PER BOX	\$ 3.69
SYL:2033	MINIATURE LAMP..1 EACH	\$ 6.10
SYL:2057	MINIATURE LAMPS..10 PER BOX	\$ 3.69
SYL:2057NA	MINIATURE LAMPS..10 PER BOX	\$ 7.25
SYL:2357	MINIATURE LAMPS..10 PER BOX	\$ 3.69
SYL:2357NA	MINIATURE LAMPS..10 PER BOX	\$ 7.95
SYL:2721	MINIATURE LAMPS..10 PER BOX	\$ 3.95
SYL:3022	MINIATURE LAMPS..10 PER BOX	\$ 3.69
SYL:DE3022	MINIATURE LAMPS..10 PER BOX	\$ 17.00
SYL:3057	MINIATURE LAMPS..10 PER BOX	\$ 5.75
SYL:3057NA	MINIATURE LAMPS..10 PER BOX	\$ 14.25
SYL:3155	MINIATURE LAMPS..10 PER BOX	\$ 10.85
SYL:3156	MINIATURE LAMPS..10 PER BOX	\$ 6.49
SYL:3156NA	MINIATURE LAMPS..10 PER BOX	\$ 25.08
SYL:3157	MINIATURE LAMPS..10 PER BOX	\$ 5.75
SYL:3157LL	MINIATURE LAMPS..10 PER BOX	\$ 10.50
SYL:3157NA	MINIATURE LAMPS..10 PER BOX	\$ 11.50
SYL:3175	MINIATURE LAMPS..10 PER BOX	\$ 10.59
SYL:3457	MINIATURE LAMPS..10 PER BOX	\$ 11.81
SYL:3457NA	MINIATURE LAMPS..10 PER BOX	\$ 15.75
SYL:3496	MINIATURE LAMPS..10 PER BOX	\$ 12.50
SYL:3496NA	MINIATURE LAMPS..10 PER BOX	\$ 23.22

Parker Brothers
gladly accepts
Visa, Mastercard
Discover &
American Express

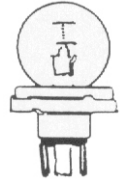

SYLVANIA

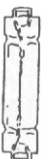
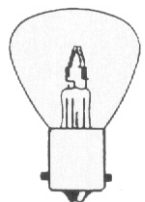
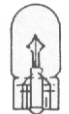
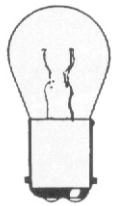
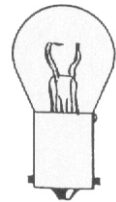

AUTOMOTIVE PARTS

BULBS

Sylvania Miniature Bulbs

SYL:3497	MINIATURE LAMPS..10 PER BOX	\$ 12.50
SYL:3757AKLL	MINIATURE LAMPS..10 PER BOX	\$ 2.41
SYL:4057	MINIATURE LAMPS..10 PER BOX	\$ 13.00
SYL:4057LL	MINIATURE LAMPS..10 PER BOX	\$ 13.10
SYL:4114KLL	MINIATURE LAMPS..10 PER BOX	\$ 5.75
SYL:4157	MINIATURE LAMPS..10 PER BOX	\$ 16.10
SYL:4157NA	MINIATURE LAMPS..10 PER BOX	\$ 49.99
SYL:4157LL	MINIATURE LAMPS..10 PER BOX	\$ 23.70
SYL:5007	MINIATURE LAMPS..10 PER BOX	\$ 2.10
SYL:6411	MINIATURE LAMPS..10 PER BOX	\$ 3.38
SYL:6418	MINIATURE LAMPS..10 PER BOX	\$ 7.32
SYL:6451	MINIATURE LAMPS..10 PER BOX	\$ 5.95
SYL:7225	MINIATURE LAMPS..10 PER BOX	\$ 5.58
SYL:7440	MINIATURE LAMPS..10 PER BOX	\$ 11.50
SYL:7443	MINIATURE LAMPS..10 PER BOX	\$ 10.50
SYL:7506	MINIATURE LAMPS..10 PER BOX	\$ 6.75
SYL:12100	MINIATURE LAMPS..10 PER BOX	\$ 3.69
SYL:12100B	MINIATURE LAMPS..10 PER BOX	\$ 13.92
SYL:13050	MINIATURE LAMPS..10 PER BOX	\$ 14.34
SYL:PR2	MINIATURE LAMPS..10 PER BOX	\$ 6.00
SYL:PR3	MINIATURE LAMPS..10 PER BOX	\$ 3.69

Sylvania Miniature Bulb Cabinets

SYL:2002	CABINET FOR MINIATURE LAMPS..1 EACH	\$ 65.00
SYL:BULB-CABINET	CABINET FOR MINIATURE LAMPS..1 EACH	\$ 31.77

Sylvania Head Lights

SYL:H1	HALOGEN LAMP..1 EACH	\$ 3.69
SYL:H2	HALOGEN LAMP..1 EACH	\$ 5.35
SYL:H3	HALOGEN LAMP..1 EACH	\$ 3.65
SYL:H3C	HALOGEN LAMP..1 EACH	\$ 1.73
SYL:H4	HALOGEN LAMP..1 EACH	\$ 3.69
SYL:AB886	HALOGEN LAMP..1 EACH	\$ 4.59
SYL:H11	HALOGEN LAMP..1 EACH	\$ 10.02
SYL:H13	HALOGEN LAMP..1 EACH	\$ 11.99
SYL:H7	HALOGEN LAMP..1 EACH	\$ 5.25
SYL:4000	SEALED BEAM LAMP..1EACH	\$ 3.67
SYL:4406	SEALED BEAM LAMP..1EACH	\$ 9.31
SYL:4411-1	SEALED BEAM LAMP..1EACH	\$ 7.99
SYL:4412	SEALED BEAM LAMP..1EACH	\$ 7.37
SYL:4413	SEALED BEAM LAMP..1EACH	\$ 9.94
SYL:4414	SEALED BEAM LAMP..1EACH	\$ 11.41
SYL:4416	SEALED BEAM LAMP..1EACH	\$ 7.05
SYL:4419	SEALED BEAM LAMP..1EACH	\$ 8.05
SYL:4421	SEALED BEAM LAMP..1EACH	\$ 16.50
SYL:4436	SEALED BEAM LAMP..1EACH	\$ 10.35
SYL:4636	SEALED BEAM LAMP..1EACH	\$ 17.72
SYL:4651	SEALED BEAM LAMP..1EACH	\$ 5.75
SYL:H4651	HALOGEN SEALED BEAM LAMP..1EACH	\$ 5.37
SYL:4652	SEALED BEAM LAMP..1EACH	\$ 5.75
SYL:5001	SEALED BEAM LAMP..1EACH	\$ 3.67
SYL:H5001	SYL HALOGEN SEALED BEAM LAMP..1EACH	\$ 6.00
SYL:6006	SEALED BEAM LAMP..1EACH	\$ 7.69
SYL:6014	SEALED BEAM LAMP..1EACH	\$ 3.69
SYL:6015	SEALED BEAM LAMP..1EACH	\$ 3.69
SYL:6051LH	SEALED BEAM LAMP..1EACH	\$ 22.69
SYL:6052	SEALED BEAM LAMP..1EACH	\$ 6.95
SYL:9003	AERODYNAMIC HALOGEN HEADLAMP..1EACH	\$ 5.44
SYL:9004	AERODYNAMIC HALOGEN HEADLAMP..1EACH	\$ 3.69
SYL:9004LL	LONG LIFE AERODYNAMIC HALOGEN HEADLAMP..1EACH	\$ 6.25
SYL:9005	AERODYNAMIC HALOGEN HEADLAMP..1EACH	\$ 3.69
SYL:9005XS	AERODYNAMIC HALOGEN HEADLAMP..1EACH	\$ 19.99
SYL:9005XSLL	AERODYNAMIC HALOGEN HEADLAMP..1EACH	\$ 9.50
SYL:9006	AERODYNAMIC HALOGEN HEADLAMP..1EACH	\$ 3.69
SYL:9006LL	LONG LIFE AERODYNAMIC HALOGEN HEADLAMP..1EACH	\$ 6.00

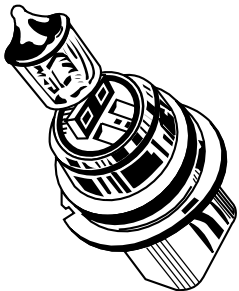
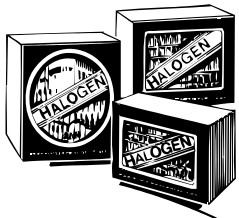
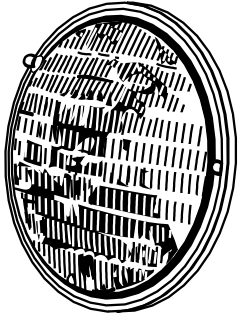
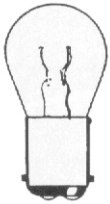

AUTOMOTIVE PARTS

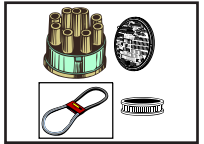

BULBS

Sylvania Head Lights

SYL:9006XS	AERODYNAMIC HALOGEN HEADLAMP..1 EACH	\$ 8.93
SYL:9006XSLL	SYL AERODYNAMICS HALOGEN HEADLAMP LONGLIFE..1 EACH	\$ 9.50
SYL:9007LL	LONG LIFE AERODYNAMIC HALOGEN HEADLAMP..1 EACH	\$ 5.61
SYL:9007	AERODYNAMIC HALOGEN HEADLAMP..1 EACH	\$ 3.69
SYL:9008	AERODYNAMIC HALOGEN HEADLAMP..1 EACH	\$ 12.50
SYL:H4351	HALOGEN SEALED BEAM LAMP..1 EACH	\$ 32.00
SYL:H4352	HALOGEN SEALED BEAM LAMP..1 EACH	\$ 32.24
SYL:H4656	SYL HALOGEN SEALED BEAM LAMP..1 EACH	\$ 8.20
SYL:H4701	SYL HALOGEN SEALED BEAM LAMP..1 EACH	\$ 12.50
SYL:H4703	SYL HALOGEN SEALED BEAM LAMP..1 EACH	\$ 12.50
SYL:H5006	SYL HALOGEN SEALED BEAM LAMP..1 EACH	\$ 6.00
SYL:H5024	SYL HALOGEN SEALED BEAM LAMP..1 EACH	\$ 14.25
SYL:H6024	SYL HALOGEN SEALED BEAM LAMP..1 EACH	\$ 12.50
SYL:H6054	SYL HALOGEN SEALED BEAM LAMP..1 EACH	\$ 11.72
SYL:H6054LL	LONG LIFE HALOGEN SEALED BEAM LAMP..1 EACH	\$ 9.31
SYL:H6054P	HALOGEN SEALED BEAM LAMP..1 EACH	\$ 11.75
SYL:H6545	HALOGEN SEALED BEAM LAMP..1 EACH	\$ 13.25
SYL:H7921-1	HALOGEN LAMP..1 EACH	\$ 17.23
SYL:H9411	HALOGEN SEALED BEAM LAMP..1 EACH	\$ 20.21
SYL:H9421	HALOGEN LAMP..1 EACH	\$ 22.64

SPARK PLUGS

Total Market

18	RV15YC4	11.2%	11.2%
404	RN12YC	8.7%	19.9%
25	RV17YC	8.0%	27.9%
71	RC12YC	7.5%	35.4%
13	RS14YC6	7.2%	42.6%
322	RN11YC4	5.5%	48.1%
405	RN14YC	5.2%	53.3%
407	RS14LC	4.2%	57.5%
19	RV19YC	3.3%	60.8%
15	RS15LYC	3.2%	64.0%
408	RS14YC	3.0%	67.0%
415	RN9YC	2.8%	69.8%
401	RS12YC	2.7%	72.5%
318	RC12MC4	1.9%	74.4%
37	RV17YC6	1.8%	76.2%
79	RV15YC6	1.8%	78.0%
31	RN14MC5	1.8%	79.8%
66	RJ18YC6	1.6%	81.4%
11	RF18YC	1.5%	82.9%
412	RC12LYC	1.5%	84.4%
113	RV12C	1.3%	85.7%
14	RJ12YC	1.2%	86.9%
406	RV12YC	1.1%	88.0%
130	RF14LC	0.9%	88.9%
308	RN12MC4	0.9%	89.8%
89	RC12YC5	0.8%	90.6%
344	RC9YC	0.7%	91.3%
17	RV19YC6	0.7%	92.0%
431	RC14YC	0.7%	92.7%
105	RN16YC5	0.6%	93.3%
20	RS13LYC5	0.5%	93.8%
302	N11YC	0.5%	94.3%
82	RFN14LY	0.5%	94.8%
418	RC9YCN4	0.4%	95.2%
184	CH84	0.4%	95.6%
21	RF14YC	0.4%	96.0%
121	RV8C	0.4%	96.4%
22	RF11YC	0.4%	96.8%
403	RS10LC	0.3%	97.1%
180	CH80	0.3%	97.4%
177	CH77	0.3%	97.7%
58	RJ18YC6	0.3%	98.0%
346	RC10YC4	0.2%	98.2%
OTHERS		1.8%	100.0%

Domestic Automobiles

13	RS14YC6	12.2%	12.2%
407	RS14LC	8.4%	20.6%
404	RN12YC	8.3%	28.9%
25	RV17YC	7.8%	36.7%
15	RS15LYC	7.0%	43.7%
405	RN14YC	6.0%	49.7%
19	RV19YC	5.6%	55.3%
37	RV17YC6	3.9%	59.2%
401	RS12YC	3.8%	63.0%
408	RS14YC	3.6%	66.6%
66	RJ18YC6	3.6%	70.2%
79	RV15YC6	3.3%	73.5%
18	RV15YC4	3.0%	76.5%
322	RN11YC4	2.6%	79.1%
406	RV12YC	2.2%	81.3%
89	RC12YC5	1.7%	83.0%
71	RC12YC	1.6%	84.6%
31	RN14MC5	1.5%	86.1%
431	RC14YC	1.5%	87.6%
17	RV19YC6	1.4%	89.0%
14	RJ12YC	1.4%	90.4%
105	RN16YC5	1.3%	91.7%
11	RF18YC	1.2%	92.9%
412	RC12LYC	0.9%	93.8%
20	RS13LYC5	0.8%	94.6%
58	RJ18YC	0.8%	95.4%
22	RF11YC	0.8%	96.2%
403	RS10LC	0.7%	96.9%
82	RFN14LY	0.6%	97.5%
OTHERS		2.5%	100.0%

Import Automobiles

71	RC12YC	31.9%	31.9%
415	RN9YC	16.7%	48.6%
322	RN11YC4	15.4%	64.0%
318	RC12MC4	10.2%	74.2%
404	RN12YC	8.2%	82.4%
308	RN12MC4	3.5%	85.9%
302	N11YC	2.8%	88.7%
418	RC9YCN4	2.6%	91.3%
344	RC9YC	1.8%	93.1%
430	RC9YC4	1.4%	94.5%
346	RC10YC4	1.0%	95.5%
401	RS12YC	0.9%	96.4%
405	RN14YC	0.5%	96.9%

Import Automobiles

304	RS9YC	0.5%	97.4%
168	CH68	0.4%	97.8%
327	RL87YC	0.4%	98.2%
161	CH61	0.2%	98.4%
169	CH69	0.2%	98.6%
332	RN7YC	0.2%	98.8%
345	RC8YC4	0.1%	98.9%
160	CH60	0.1%	99.0%
OTHER		1.0%	100.0%

Light Truck and Van

18	RV15YC4	24.8%	24.8%
25	RV17YC	11.1%	35.9%
404	RN12YC	9.4%	45.3%
405	RN14YC	6.1%	51.4%
71	RC12YC	5.2%	56.6%
322	RN11YC4	4.9%	61.5%
13	RS14YC6	4.1%	65.6%
408	RS14YC	3.5%	69.1%
113	RV12C	3.3%	72.4%
412	RC12LYC	2.8%	75.2%
31	RN14MC5	2.7%	77.9%
11	RF18YC	2.4%	80.3%

Outdoor Power Equipment

861	J19LM	36.0%	36.0%
843	CJ8	19.5%	55.5%
841	J8C	7.0%	62.5%
846	CJ14	6.5%	69.0%
844	H10C	4.0%	73.0%
845	J17LM	3.8%	76.8%
868	RJ19LM	3.0%	79.8%
847	DJ8J	2.9%	82.7%
848	CJ8Y	2.1%	84.8%
853	CJ7Y	2.0%	86.8%
855	DJ7Y	1.4%	88.2%
302	N11YC	1.2%	89.4%
849	CJ6	1.0%	90.4%
850	DJ7J	1.0%	91.4%
823	J6C	1.0%	92.4%
592	RJ12C	0.9%	93.3%
71	RC12YC	0.8%	94.1%
431	RC14YC	0.6%	94.7%
OTHER		5.3%	100.0%

AUTOMOTIVE PARTS

SPARK PLUGS

Champion Spark Plugs

CHA:10	SPARK PLUG J12YC..1 EACH	\$ 1.68
CHA:11	SPARK PLUG RF18YC..1 EACH	\$ 1.71
CHA:13	SPARK PLUG RS14YC6..1 EACH	\$ 1.60
CHA:14	SPARK PLUG RJ12YC..1 EACH	\$ 1.71
CHA:15	SPARK PLUG RS15LYC..1 EACH	\$ 1.71
CHA:17	SPARK PLUG RV19YC6..1 EACH	\$ 1.71
CHA:18	SPARK PLUG RV15YC4..1 EACH	\$ 1.60
CHA:19	SPARK PLUG RV19YC..1 EACH	\$ 1.71
CHA:20	SPARK PLUG RS13LYC5..1 EACH	\$ 1.71
CHA:21	SPARK PLUG RF14YC..1 EACH	\$ 1.71
CHA:22	SPARK PLUG RF11YC..1 EACH	\$ 1.71
CHA:25	SPARK PLUG RV17YC..1 EACH	\$ 1.60
CHA:31	SPARK PLUG RN14MC5..1 EACH	\$ 1.71
CHA:35	SPARK PLUG RV12C6..1 EACH	\$ 1.71
CHA:37	SPARK PLUG RV17YC6..1 EACH	\$ 1.99
CHA:38	SPARK PLUG N12YC..1 EACH	\$ 1.60
CHA:58	SPARK PLUG RJ18YC..1 EACH	\$ 1.71
CHA:63	SPARK PLUG RJ14YC..1 EACH	\$ 1.71
CHA:66	SPARK PLUG..1 EACH	\$ 1.71
CHA:71	SPARK PLUG RC12YC..1 EACH	\$ 1.63
CHA:79	SPARK PLUG RV15YC6..1 EACH	\$ 1.71
CHA:82	SPARK PLUG RFN14LY..1 EACH	\$ 1.71
CHA:89	SPARK PLUG RC12YC5..1 EACH	\$ 1.71
CHA:101	SPARK PLUG RN13YL..1 EACH	\$ 1.71
CHA:104	SPARK PLUG..1 EACH	\$ 1.80
CHA:105	SPARK PLUG RN16YC5..1 EACH	\$ 1.71
CHA:106	SPARK PLUG RZF10..1 EACH	\$ 2.58
CHA:113	SPARK PLUG RV12C..1 EACH	\$ 1.71
CHA:120	SPARK PLUG N5C..1 EACH	\$ 1.55
CHA:121	SPARK PLUG RV8C..1 EACH	\$ 1.71
CHA:123	SPARK PLUG RN5C..1 EACH	\$ 1.80
CHA:129	SPARK PLUG RF10C..1 EACH	\$ 1.71
CHA:130	SPARK PLUG RF14LC..1 EACH	\$ 1.71
CHA:180	GLOW PLUG CH80..1 EACH	\$ 10.11
CHA:184	GLOW PLUG CH84..1 EACH	\$ 10.11
CHA:220	SPARK PLUG..1 EACH	\$ 6.09
CHA:300	SPARK PLUG N9YC..1 EACH	\$ 1.60
CHA:302	SPARK PLUG N11YC..1 EACH	\$ 1.60
CHA:304	SPARK PLUG RS9YC..1 EACH	\$ 1.71
CHA:306	SPARK PLUG L86C..1 EACH	\$ 1.55
CHA:308	SPARK PLUG RN12MC4..1 EACH	\$ 1.71
CHA:312	SPARK PLUG L87YC2..1 EACH	\$ 1.63
CHA:318	SPARK PLUG RC12MC4..1 EACH	\$ 1.71
CHA:322	SPARK PLUG RN11YC4..1 EACH	\$ 1.63
CHA:328	SPARK PLUG L82YC..1 EACH	\$ 1.55
CHA:344	SPARK PLUG RC9YC..1 EACH	\$ 1.71
CHA:401	SPARK PLUG RS12YC..1 EACH	\$ 1.71
CHA:403	SPARK PLUG RS10LC..1 EACH	\$ 1.71
CHA:404	SPARK PLUG RN12YC..1 EACH	\$ 1.65
CHA:405	SPARK PLUG RN14YC..1 EACH	\$ 1.65
CHA:405C	SPARK PLUG RN14YC..1 EACH	\$ 6.55
CHA:406	SPARK PLUG RV12YC..1 EACH	\$ 1.71
CHA:407	SPARK PLUG RS14LC..1 EACH	\$ 1.65
CHA:408	SPARK PLUG RS14YC..1 EACH	\$ 1.71
CHA:412	SPARK PLUG RC12LYC..1 EACH	\$ 1.65
CHA:415	SPARK PLUG RN9YC..1 EACH	\$ 1.71
CHA:418	SPARK PLUG RC9YCN4..1 EACH	\$ 1.76
CHA:430	SPARK PLUG RC9YC4..1 EACH	\$ 1.71
CHA:431	SPARK PLUG RC14YC..1 EACH	\$ 1.71
CHA:436	SPARK PLUG..1 EACH	\$ 1.43
CHA:438	SPARK PLUG..1 EACH	\$ 1.71
CHA:502	SPARK PLUG D21..1 EACH	\$ 1.77
CHA:516	SPARK PLUG D16..1 EACH	\$ 1.77
CHA:523	SPARK PLUG D23..1 EACH	\$ 4.44
CHA:533	SPARK PLUG UJ11G..1 EACH	\$ 8.12
CHA:538	SPARK PLUG RH8C..1 EACH	\$ 2.11

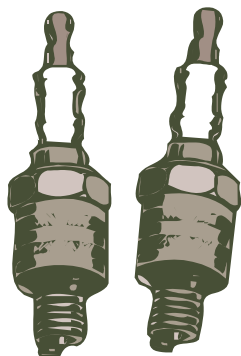
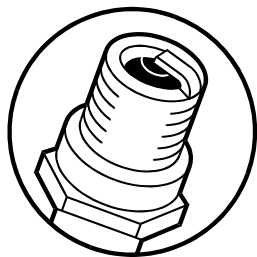
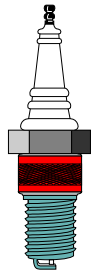

AUTOMOTIVE PARTS

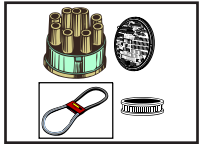

SPARK PLUGS

Champion Spark Plugs

CHA:555	SPARK PLUG UD16..1EACH	\$ 1.77
CHA:561	SPARK PLUG W16Y..1EACH	\$ 5.75
CHA:564	SPARK PLUG D16J..1EACH	\$ 1.77
CHA:587	SPARK PLUG H8C..1EACH	\$ 1.68
CHA:592	SPARK PLUG RJ12C..1EACH	\$ 2.06
CHA:679	HIGH PERFORMANCE SPARK PLUG L55C..1EACH	\$ 3.02
CHA:680	HIGH PERFORMANCE SPARK PLUG L57C..1EACH	\$ 3.02
CHA:682	SPARK PLUG S57C..1EACH	\$ 3.12
CHA:683	SPARK PLUG S59C..1EACH	\$ 3.12
CHA:801	SPARK PLUG N3C..1EACH	\$ 1.57
CHA:803	SPARK PLUG N4C..1EACH	\$ 1.57
CHA:805	SPARK PLUG N2C..1EACH	\$ 1.57
CHA:805C	SPARK PLUG..1EACH	\$ 1.57
CHA:806	SPARK PLUG L92YC..1EACH	\$ 1.80
CHA:807	SPARK PLUG L78C..1EACH	\$ 1.57
CHA:808	SPARK PLUG Z9Y..1EACH	\$ 2.72
CHA:809	SPARK PLUG RA6HC..1EACH	\$ 1.80
CHA:810	SPARK PLUG..1EACH	\$ 1.50
CHA:810C	SPARK PLUG RA8HC..1EACH	\$ 1.80
CHA:811	SPARK PLUG L82YC..1EACH	\$ 1.57
CHA:814	SPARK PLUG RL82YC..1EACH	\$ 2.34
CHA:821	SPARK PLUG L77JC4..1EACH	\$ 1.57
CHA:823	SPARK PLUG J6C..1EACH	\$ 1.57
CHA:823C	SPARK PLUG..1EACH	\$ 1.57
CHA:827	SPARK PLUG L76V..1EACH	\$ 2.72
CHA:828	SPARK PLUG QL77JC4..1EACH	\$ 2.72
CHA:830	SPARK PLUG RL86C..1EACH	\$ 2.07
CHA:833	SPARK PLUG L78V..1EACH	\$ 2.72
CHA:837	SPARK PLUG L20V..1EACH	\$ 2.11
CHA:840	SPARK PLUG RCJ8..1EACH	\$ 2.03
CHA:841	SPARK PLUG J8C..1EACH	\$ 1.48
CHA:841C	SPARK PLUG J8C..1EACH	\$ 1.48
CHA:843	SPARK PLUG CJ8..1EACH	\$ 1.48
CHA:843C	SPARK PLUG CJ8..1EACH	\$ 1.48
CHA:843S	SHOP PACK SPARK PLUGS CJ8..24 PER PACK	\$ 31.20
CHA:844	SPARK PLUG..1EACH	\$ 1.37
CHA:844C	SPARK PLUG..1EACH	\$ 1.68
CHA:845	SPARK PLUG J17LM..1EACH	\$ 1.48
CHA:845C	SPARK PLUG..1EACH	\$ 1.48
CHA:846	SPARK PLUG CJ14..1EACH	\$ 1.57
CHA:846C	SPARK PLUG..1EACH	\$ 1.57
CHA:847	SPARK PLUG DJ8J..1EACH	\$ 1.48
CHA:847C	SPARK PLUG 847-1..1EACH	\$ 1.57
CHA:848	SPARK PLUG CJ8Y..1EACH	\$ 1.68
CHA:849	SPARK PLUG CJ6..1EACH	\$ 1.57
CHA:850	SPARK PLUG DJ7J..1EACH	\$ 1.57
CHA:851	SPARK PLUG DJ6J..1EACH	\$ 1.57
CHA:851C	SPARK PLUG DJ6J..1EACH	\$ 1.57
CHA:852	SPARK PLUG RCJ6Y..1EACH	\$ 2.03
CHA:853	SPARK PLUG CJ7Y..1EACH	\$ 1.68
CHA:853C	SPARK PLUG 853-1..1EACH	\$ 1.60
CHA:854	SPARK PLUG RH10C..1EACH	\$ 2.11
CHA:855	SPARK PLUG DJ7Y..1EACH	\$ 1.68
CHA:857	SPARK PLUG RH18Y..1EACH	\$ 2.20
CHA:858	SPARK PLUG CJ6Y..1EACH	\$ 1.68
CHA:859	SPARK PLUG RCJ7Y..1EACH	\$ 2.03
CHA:861	SPARK PLUG J19LM..1EACH	\$ 1.57
CHA:861C	SPARK PLUG 861-1..1EACH	\$ 1.57
CHA:868	SPARK PLUG RJ19LM..1EACH	\$ 1.94
CHA:868C	SPARK PLUG 868-1..1EACH	\$ 1.94
CHA:872	PARK PLUG RDJ7Y..1EACH	\$ 3.15
CHA:876	SPARK PLUG QL16V..1EACH	\$ 5.42
CHA:896	SPARK PLUG L90C..1EACH	\$ 2.11
CHA:898	SPARK PLUG QL76V..1EACH	\$ 5.42
CHA:909	SPARK PLUG RS17YX..1EACH	\$ 1.80

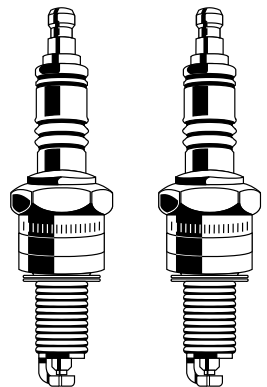
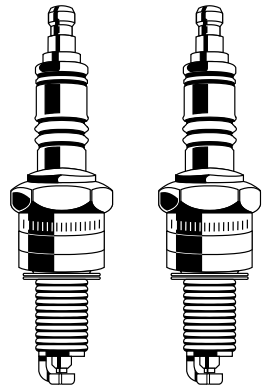

AUTOMOTIVE PARTS

SPARK PLUGS

Champion Spark Plugs

CHA:929	SPARK PLUG RL95YC..1 EACH	\$ 1.80
CHA:2013	PREMIUM GOLD SPARK PLUG..1 EACH	\$ 2.46
CHA:2015	PREMIUM GOLD SPARK PLUG..1 EACH	\$ 2.46
CHA:2018	PREMIUM GOLD SPARK PLUG..1 EACH	\$ 2.46
CHA:2025	PREMIUM GOLD SPARK PLUG..1 EACH	\$ 2.46
CHA:2071	SPARK PLUG..1 EACH	\$ 2.30
CHA:2319	PREMIUM GOLD SPARK PLUG..1 EACH	\$ 2.46
CHA:2401	PREMIUM GOLD SPARK PLUG..1 EACH	\$ 2.46
CHA:2405	PREMIUM GOLD SPARK PLUG..1 EACH	\$ 2.46
CHA:2407	PREMIUM GOLD SPARK PLUG..1 EACH	\$ 2.46
CHA:2408	PREMIUM GOLD SPARK PLUG..1 EACH	\$ 2.46
CHA:2415	PREMIUM GOLD SPARK PLUG..1 EACH	\$ 2.46
CHA:3013	SPARK PLUG..1 EACH	\$ 2.70
CHA:3071	SPARK PLUG..1 EACH	\$ 5.05
CHA:4011	TRUCK SPARK PLUG 4011..1 EACH	\$ 2.39
CHA:4013	TRUCK SPARK PLUG 4013..1 EACH	\$ 2.39
CHA:4018	TRUCK SPARK PLUG 4018..1 EACH	\$ 2.39
CHA:4019	TRUCK SPARK PLUG 4019..1 EACH	\$ 2.39
CHA:4025	TRUCK SPARK PLUG 4025..1 EACH	\$ 2.39
CHA:4071	TRUCK SPARK PLUG..1 EACH	\$ 2.39
CHA:4079	TRUCK SPARK PLUG..1 EACH	\$ 2.39
CHA:4113	TRUCK SPARK PLUG..1 EACH	\$ 2.39
CHA:4130	TRUCK SPARK PLUG..1 EACH	\$ 2.39
CHA:4163	SPARK PLUG RCJ7Y..1 EACH	\$ 2.03
CHA:4401	TRUCK SPARK PLUG..1 EACH	\$ 2.39
CHA:4404	TRUCK SPARK PLUG..1 EACH	\$ 2.39
CHA:4405	TRUCK SPARK PLUG..1 EACH	\$ 2.39
CHA:4408	TRUCK SPARK PLUG..1 EACH	\$ 2.39
CHA:4412	TRUCK SPARK PLUG..1 EACH	\$ 2.39
CHA:4430	TRUCK SPARK PLUG..1 EACH	\$ 2.39
CHA:7013	DOUBLE PLATINUM SPARK PLUG RS14PYP6..1 EACH	\$ 5.05
CHA:7020	DOUBLE PLATINUM SPARK PLUG RS12PLP..1 EACH	\$ 5.05
CHA:7031	DOUBLE PLATINUM SPARK PLUG RN14PMP5..1 EACH	\$ 5.05
CHA:7071	DOUBLE PLATINUM SPARK PLUG RC12PYP..1 EACH	\$ 5.05
CHA:7346	DOUBLE PLATINUM SPARK PLUG RC10PYP4..1 EACH	\$ 5.05
CHA:7401	DOUBLE PLATINUM SPARK PLUG..1 EACH	\$ 5.05
CHA:7407	DOUBLE PLATINUM SPARK PLUG RS14PLP..1 EACH	\$ 5.05
CHA:7408	DOUBLE PLATINUM SPARK PLUG RS14PYP..1 EACH	\$ 5.05

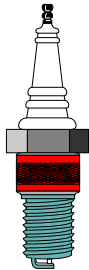

FOR 50+ YEARS,
PARKER
BROTHERS
HAS BEEN
SERVING ATLANTA.
THANK YOU FOR
YOUR CONTINUED
SUPPORT!!

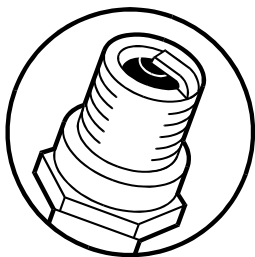

Champion Spark Plug Gapper

CHA:CT481	CIRCULAR TAPER GAP GAUGE 91671..1 EACH	\$ 1.51
-----------	--	---------

AC Delco Spark Plugs

ACP:AC2	SPARK PLUG	\$ 4.99
ACP:ACP8	SPARK PLUG	\$ 6.99
ACP:FR3LM	SPARK PLUG	\$ 2.29
ACP:FR3LS6	SPARK PLUG	\$ 1.73
ACP:8G	GLOW PLUG	\$ 9.68
ACP:32G	GLOW PLUG	\$ 12.12
ACP:R42CXLS	SPARK PLUG	\$ 1.73
ACP:R42LTS	SPARK PLUG	\$ 1.61
ACP:R42TS	SPARK PLUG	\$ 1.61
ACP:CR43TS	SPARK PLUG	\$ 1.93
ACP:CR43TSM	SPARK PLUG	\$ 1.93
ACP:R43CT	SPARK PLUG	\$ 1.58
ACP:R43CXLS	SPARK PLUG	\$ 1.73
ACP:R43NTS6	SPARK PLUG	\$ 1.73
ACP:R43NTSE	SPARK PLUG	\$ 1.73
ACP:R43T	SPARK PLUG	\$ 1.61
ACP:R43TS	SPARK PLUG	\$ 1.61
ACP:R43TS6	SPARK PLUG	\$ 1.31
ACP:R43XLS	SPARK PLUG	\$ 1.31
ACP:R44LTS	SPARK PLUG	\$ 1.31
ACP:R44LTS6	SPARK PLUG	\$ 1.73
ACP:R44S	SPARK PLUG	\$ 1.80
ACP:R44SX	SPARK PLUG	\$ 1.73



AUTOMOTIVE PARTS

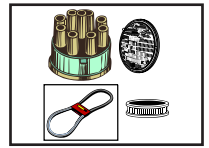

SPARK PLUGS

AC Delco Spark Plugs

ACP:R44T	SPARK PLUG	\$ 1.61
ACP:R44TS	SPARK PLUG	\$ 1.61
ACP:R44TS8	SPARK PLUG	\$ 1.73
ACP:R44TSX	SPARK PLUG	\$ 1.79
ACP:R44TX	SPARK PLUG	\$ 1.61
ACP:R44XLS	SPARK PLUG	\$ 1.73
ACP:R44XLSE	SPARK PLUG	\$ 1.73
ACP:R44XLSM	SPARK PLUG	\$ 1.73
ACP:45S	SPARK PLUG	\$ 1.52
ACP:45TS	SPARK PLUG	\$ 1.52
ACP:R45	SPARK PLUG	\$ 1.61
ACP:R45LTS6	SPARK PLUG	\$ 1.73
ACP:R45NS	SPARK PLUG	\$ 1.80
ACP:R45S	SPARK PLUG	\$ 1.61
ACP:R45T	SPARK PLUG	\$ 1.61
ACP:R45TS	SPARK PLUG	\$ 1.61
ACP:R45TS8	SPARK PLUG	\$ 1.73
ACP:R45TSX	SPARK PLUG	\$ 1.73
ACP:R45XLS	SPARK PLUG	\$ 1.73
ACP:R45XLS6	SPARK PLUG	\$ 1.73
ACP:46	SPARK PLUG	\$ 1.52
ACP:R46S	SPARK PLUG	\$ 1.73
ACP:R46T	SPARK PLUG	\$ 1.73
ACP:R46TS	SPARK PLUG	\$ 1.73
ACP:R46TSX	SPARK PLUG	\$ 1.73
ACP:R46TX	SPARK PLUG	\$ 1.73
ACP:60G	SPARK PLUG	\$ 10.67
ACP:R85TS	SPARK PLUG	\$ 1.73
ACP:C86	SPARK PLUG	\$ 1.76
ACP:41-601	SPARK PLUG	\$ 1.73
ACP:41-906	SPARK PLUG	\$ 6.36
ACP:41-932	SPARK PLUG	\$ 6.36

ACDelco

ACDelco

ACDelco

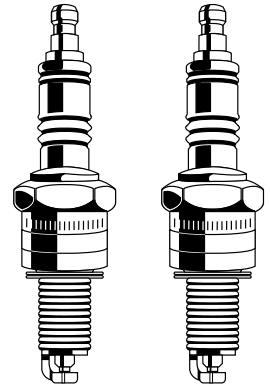

FILTERS

Premium Oil Filters

POF:POF1A	PREMIUM GUARD OIL FILTER	\$ 1.62
POF:POF33	PREMIUM GUARD OIL FILTER	\$ 1.67
POF:POF49	PREMIUM GUARD OIL FILTER	\$ 1.80
POF:POF111	PREMIUM GUARD OIL FILTER	\$ 1.64
POF:POF123	PREMIUM GUARD OIL FILTER	\$ 1.59
POF:POF193	PREMIUM GUARD OIL FILTER	\$ 1.50
POF:POF195	PREMIUM GUARD OIL FILTER	\$ 1.69
POF:POF2222	PREMIUM GUARD OIL FILTER	\$ 2.37
POF:POF241	PREMIUM GUARD OIL FILTER	\$ 1.62
POF:POF252	PREMIUM GUARD OIL FILTER	\$ 1.67
POF:POF257	PREMIUM GUARD OIL FILTER	\$ 2.40
POF:POF2500	PREMIUM GUARD OIL FILTER	\$ 1.67
POF:POF2821A	PREMIUM GUARD OIL FILTER	\$ 1.99
POF:POF4006	PREMIUM GUARD OIL FILTER	\$ 1.52
POF:POF4011	PREMIUM GUARD OIL FILTER	\$ 1.64
POF:POF4457	PREMIUM GUARD OIL FILTER	\$ 1.67
POF:POF4459	PREMIUM GUARD OIL FILTER	\$ 1.64
POF:POF4460	PREMIUM GUARD OIL FILTER	\$ 1.67
POF:POF4466	PREMIUM GUARD OIL FILTER	\$ 1.67
POF:POF4476	PREMIUM GUARD OIL FILTER	\$ 1.49
POF:POF4477	PREMIUM GUARD OIL FILTER	\$ 1.59
POF:POF4484	PREMIUM GUARD OIL FILTER	\$ 1.67
POF:POF4610	PREMIUM GUARD OIL FILTER	\$ 1.70
POF:POF4612	PREMIUM GUARD OIL FILTER	\$ 1.56
POF:POF4631	PREMIUM GUARD OIL FILTER	\$ 1.85
POF:POF4651	PREMIUM GUARD OIL FILTER	\$ 1.77
POF:POF4670	PREMIUM GUARD OIL FILTER	\$ 1.77
POF:POF4757	PREMIUM GUARD OIL FILTER	\$ 4.04

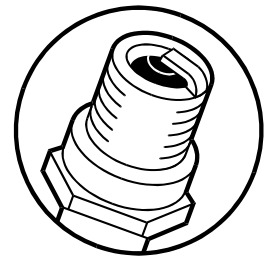

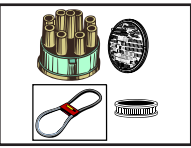

AUTOMOTIVE PARTS

FILTERS

Premium Oil Filters

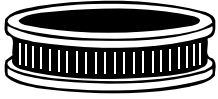

POF:POF4872	PREMIUM GUARD OIL FILTER	\$ 7.30
POF:POF4878	PREMIUM GUARD OIL FILTER	\$ 1.67
POF:POF5230	PREMIUM GUARD OIL FILTER	\$ 1.67
POF:POF5248	PREMIUM GUARD OIL FILTER	\$ 3.24
POF:POF5274	PREMIUM GUARD OIL FILTER	\$ 2.31
POF:POF5276	PREMIUM GUARD OIL FILTER	\$ 4.14
POF:POF5280	PREMIUM GUARD OIL FILTER	\$ 4.05
POF:POF5288	PREMIUM GUARD OIL FILTER	\$ 1.67
POF:POF5309	PREMIUM GUARD OIL FILTER	\$ 2.72
POF:POF5313	PREMIUM GUARD OIL FILTER	\$ 2.65
POF:POF5315	PREMIUM GUARD OIL FILTER	\$ 4.00
POF:POF5316	PREMIUM GUARD OIL FILTER	\$ 3.72
POF:POF5317	PREMIUM GUARD OIL FILTER	\$ 1.80
POF:POF5401	PREMIUM GUARD OIL FILTER	\$ 3.00
POF:POF5409	PREMIUM GUARD OIL FILTER	\$ 1.97
POF:POF5436	PREMIUM GUARD OIL FILTER	\$ 2.45
POF:POF5505	PREMIUM GUARD OIL FILTER	\$ 3.63
POF:POF5515	PREMIUM GUARD OIL FILTER	\$ 5.71
POF:POF5526	PREMIUM GUARD OIL FILTER	\$ 5.61
POF:POF5536	PREMIUM GUARD OIL FILTER	\$ 3.87
POF:POF5581	PREMIUM GUARD OIL FILTER	\$ 2.91
POF:POF5608	PREMIUM GUARD OIL FILTER	\$ 4.43
POF:POF5610	PREMIUM GUARD OIL FILTER	\$ 5.04
POF:POF5839	PREMIUM GUARD OIL FILTER	\$ 4.67
POF:POF5895	PREMIUM GUARD OIL FILTER	\$ 9.77
POF:POF6135	PREMIUM GUARD OIL FILTER	\$ 6.27
POF:POF6311	PREMIUM GUARD OIL FILTER	\$ 2.78
POF:POF7019	PREMIUM GUARD OIL FILTER	\$ 1.99

Premium Air Filters

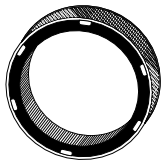
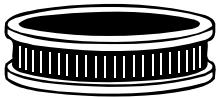

POF:PAF4	PREMIUM GUARD AIR FILTER	\$ 2.46
POF:PAF67	PREMIUM GUARD AIR FILTER	\$ 2.46
POF:PAF91	PREMIUM GUARD AIR FILTER	\$ 2.46
POF:PAF3192	PREMIUM GUARD AIR FILTER	\$ 2.46
POF:PAF3195	PREMIUM GUARD AIR FILTER	\$ 2.46
POF:PAF3380	PREMIUM GUARD AIR FILTER	\$ 2.46
POF:PAF3465	PREMIUM GUARD AIR FILTER	\$ 2.46
POF:PAF3590	PREMIUM GUARD AIR FILTER	\$ 2.89
POF:PAF3592	PREMIUM GUARD AIR FILTER	\$ 2.46
POF:PAF4243	PREMIUM GUARD AIR FILTER	\$ 2.46
POF:PAF4278	PREMIUM GUARD AIR FILTER	\$ 5.95
POF:PAF4297	PREMIUM GUARD AIR FILTER	\$ 4.02
POF:PAF4343	PREMIUM GUARD AIR FILTER	\$ 3.72
POF:PAF4372	PREMIUM GUARD AIR FILTER	\$ 3.24
POF:PAF4375	PREMIUM GUARD AIR FILTER	\$ 6.34
POF:PAF4378	PREMIUM GUARD AIR FILTER	\$ 3.03
POF:PAF4459	PREMIUM GUARD AIR FILTER	\$ 6.99
POF:PAF4468	PREMIUM GUARD AIR FILTER	\$ 5.07
POF:PAF4479	PREMIUM GUARD AIR FILTER	\$ 3.03
POF:PAF4613	PREMIUM GUARD AIR FILTER	\$ 4.62
POF:PAF4633	PREMIUM GUARD AIR FILTER	\$ 4.54
POF:PAF4645	PREMIUM GUARD AIR FILTER	\$ 6.53
POF:PAF4648	PREMIUM GUARD AIR FILTER	\$ 5.46
POF:PAF4650	PREMIUM GUARD AIR FILTER	\$ 4.46
POF:PAF4669	PREMIUM GUARD AIR FILTER	\$ 5.94
POF:PAF4675	PREMIUM GUARD AIR FILTER	\$ 5.22
POF:PAF4680	PREMIUM GUARD AIR FILTER	\$ 6.14
POF:PAF4690	PREMIUM GUARD AIR FILTER	\$ 4.33
POF:PAF4712	PREMIUM GUARD AIR FILTER	\$ 2.46
POF:PAF4715	PREMIUM GUARD AIR FILTER	\$ 9.60
POF:PAF4720	PREMIUM GUARD AIR FILTER	\$ 3.24
POF:PAF4721	PREMIUM GUARD AIR FILTER	\$ 8.12
POF:PAF4722	PREMIUM GUARD AIR FILTER	\$ 6.14
POF:PAF4727	PREMIUM GUARD AIR FILTER	\$ 3.24
POF:PAF4731	PREMIUM GUARD AIR FILTER	\$ 2.46

MONDAY-FRIDAY
8am-5pm a helpful
HUMAN voice will
always answer the
phone
(770)474-1286

(770)474-1286

14-14

AUTOMOTIVE PARTS

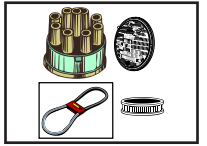

FILTERS

Premium Air Filters

POF:PAF4819	PREMIUM GUARD AIR FILTER	\$ 3.17
POF:PAF4831	PREMIUM GUARD AIR FILTER	\$ 4.24
POF:PAF4850	PREMIUM GUARD AIR FILTER	\$ 4.68
POF:PAF4852	PREMIUM GUARD AIR FILTER	\$ 5.70
POF:PAF4858	PREMIUM GUARD AIR FILTER	\$ 4.43
POF:PAF4859	PREMIUM GUARD AIR FILTER	\$ 4.95
POF:PAF4873	PREMIUM GUARD AIR FILTER	\$ 6.53
POF:PAF4877	PREMIUM GUARD AIR FILTER	\$ 4.59
POF:PAF4878	PREMIUM GUARD AIR FILTER	\$ 5.45
POF:PAF4879	PREMIUM GUARD AIR FILTER	\$ 5.27
POF:PAF4880	PREMIUM GUARD AIR FILTER	\$ 3.45
POF:PAF4881	PREMIUM GUARD AIR FILTER	\$ 3.45
POF:PAF4886	PREMIUM GUARD AIR FILTER	\$ 6.95
POF:PAF5048	PREMIUM GUARD AIR FILTER	\$ 5.54
POF:PAF5049	PREMIUM GUARD AIR FILTER	\$ 6.62
POF:PAF5090	PREMIUM GUARD AIR FILTER	\$ 6.91
POF:PAF5148	PREMIUM GUARD AIR FILTER	\$ 4.19
POF:PAF5150	PREMIUM GUARD AIR FILTER	\$ 5.32
POF:PAF5155	PREMIUM GUARD AIR FILTER	\$ 5.32
POF:PAF5192	PREMIUM GUARD AIR FILTER	\$ 3.24
POF:PAF5219	PREMIUM GUARD AIR FILTER	\$ 6.56
POF:PAF5227	PREMIUM GUARD AIR FILTER	\$ 3.24
POF:PAF5244	PREMIUM GUARD AIR FILTER	\$ 6.55
POF:PAF5248	PREMIUM GUARD AIR FILTER	\$ 4.72
POF:PAF5249	PREMIUM GUARD AIR FILTER	\$ 6.85
POF:PAF5257	PREMIUM GUARD AIR FILTER	\$ 3.56
POF:PAF5265	PREMIUM GUARD AIR FILTER	\$ 5.32
POF:PAF5278	PREMIUM GUARD AIR FILTER	\$ 5.52
POF:PAF5290	PREMIUM GUARD AIR FILTER	\$ 5.52
POF:PAF5305	PREMIUM GUARD AIR FILTER	\$ 5.78
POF:PAF5314	PREMIUM GUARD AIR FILTER	\$ 5.98
POF:PAF5323	PREMIUM GUARD AIR FILTER	\$ 5.32
POF:PAF5324	PREMIUM GUARD AIR FILTER	\$ 6.62
POF:PAF5330	PREMIUM GUARD AIR FILTER	\$ 5.28
POF:PAF5363	PREMIUM GUARD AIR FILTER	\$ 6.21
POF:PAF5370	PREMIUM GUARD AIR FILTER	\$ 5.19
POF:PAF5372	PREMIUM GUARD AIR FILTER	\$ 5.78
POF:PAF5373	PREMIUM GUARD AIR FILTER	\$ 4.10
POF:PAF5395	PREMIUM GUARD AIR FILTER	\$ 3.90
POF:PAF5396	PREMIUM GUARD AIR FILTER	\$ 5.45
POF:PAF5397	PREMIUM GUARD AIR FILTER	\$ 8.86
POF:PAF5400	PREMIUM GUARD AIR FILTER	\$ 8.76
POF:PAF5405	PREMIUM GUARD AIR FILTER	\$ 5.07
POF:PAF5414	PREMIUM GUARD AIR FILTER	\$ 4.83
POF:PAF5418	PREMIUM GUARD AIR FILTER	\$ 5.45
POF:PAF5420	PREMIUM GUARD AIR FILTER	\$ 3.66
POF:PAF5431	PREMIUM GUARD AIR FILTER	\$ 7.49
POF:PAF5432	PREMIUM GUARD AIR FILTER	\$ 5.26
POF:PAF5433	PREMIUM GUARD AIR FILTER	\$ 8.30
POF:PAF5446	PREMIUM GUARD AIR FILTER	\$ 8.39
POF:PAF5456	PREMIUM GUARD AIR FILTER	\$ 6.30
POF:PAF5462	PREMIUM GUARD AIR FILTER	\$ 8.05
POF:PAF5496	PREMIUM GUARD AIR FILTER	\$ 4.79
POF:PAF5503	PREMIUM GUARD AIR FILTER	\$ 5.96
POF:PAF5507	PREMIUM GUARD AIR FILTER	\$ 6.42
POF:PAF5512	PREMIUM GUARD AIR FILTER	\$ 5.99
POF:PAF5513	PREMIUM GUARD AIR FILTER	\$ 5.22
POF:PAF5525	PREMIUM GUARD AIR FILTER	\$ 4.89
POF:PAF5528	PREMIUM GUARD AIR FILTER	\$ 9.45
POF:PAF5534	PREMIUM GUARD AIR FILTER	\$ 5.45
POF:PAF5553	PREMIUM GUARD AIR FILTER	\$ 4.15
POF:PAF5556	PREMIUM GUARD AIR FILTER	\$ 6.83
POF:PAF5560	PREMIUM GUARD AIR FILTER	\$ 4.99
POF:PAF5566	PREMIUM GUARD AIR FILTER	\$ 5.84
POF:PAF5568	PREMIUM GUARD AIR FILTER	\$ 6.02

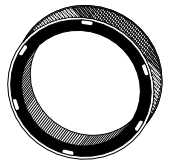
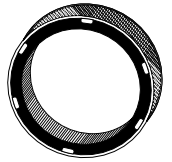
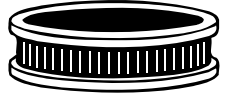

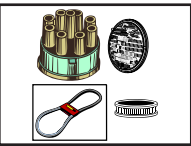

AUTOMOTIVE PARTS

FILTERS

Premium Air Filters

POF:PAF5578	PREMIUM GUARD AIR FILTER	\$ 8.78
POF:PAF5588	PREMIUM GUARD AIR FILTER	\$ 5.99
POF:PAF5601	PREMIUM GUARD AIR FILTER	\$ 5.37
POF:PAF5602	PREMIUM GUARD AIR FILTER	\$ 8.49
POF:PAF5603	PREMIUM GUARD AIR FILTER	\$ 8.01
POF:PAF5634	PREMIUM GUARD AIR FILTER	\$ 3.12
POF:PAF5635	PREMIUM GUARD AIR FILTER	\$ 5.22
POF:PAF5642	PREMIUM GUARD AIR FILTER	\$ 9.75
POF:PAF5649	PREMIUM GUARD AIR FILTER	\$ 6.05
POF:PAF5650	PREMIUM GUARD AIR FILTER	\$ 8.22
POF:PAF5651	PREMIUM GUARD AIR FILTER	\$ 6.81
POF:PAF5655	PREMIUM GUARD AIR FILTER	\$ 5.24
POF:PAF5669	PREMIUM GUARD AIR FILTER	\$ 7.02
POF:PAF5671	PREMIUM GUARD AIR FILTER	\$ 8.93
POF:PAF5672	PREMIUM GUARD AIR FILTER	\$ 7.99
POF:PAF5673	PREMIUM GUARD AIR FILTER	\$ 6.89
POF:PAF5698	PREMIUM GUARD AIR FILTER	\$ 6.56
POF:PAF5701	PREMIUM GUARD AIR FILTER	\$ 6.89
POF:PAF5703	PREMIUM GUARD AIR FILTER	\$ 5.19
POF:PAF5707	PREMIUM GUARD AIR FILTER	\$ 8.10
POF:PAF6067	PREMIUM GUARD AIR FILTER	\$ 7.85

Group 7 Oil Filters

PUR:V1A	OIL FILTER..1 EACH	\$ 2.24
PUR:V33	OIL FILTER..1 EACH	\$ 3.19
PUR:V49	OIL FILTER..1 EACH	\$ 2.29
PUR:V64	OIL FILTER..1 EACH	\$ 3.04
PUR:V85	OIL FILTER..1 EACH	\$ 3.19
PUR:V111	OIL FILTER..1 EACH	\$ 2.36
PUR:V183	OIL FILTER..1 EACH	\$ 3.52
PUR:V193	OIL FILTER..1 EACH	\$ 2.93
PUR:V195	OIL FILTER..1 EACH	\$ 2.24
PUR:V241	OIL FILTER..1 EACH	\$ 2.24
PUR:V252	OIL FILTER..1 EACH	\$ 3.04
PUR:V288	OIL FILTER..1 EACH	\$ 7.06
PUR:V291	OIL FILTER..1 EACH	\$ 3.45
PUR:V2167	OIL FILTER..1 EACH	\$ 3.19
PUR:V2222	OIL FILTER..1 EACH	\$ 3.15
PUR:V2500	OIL FILTER..1 EACH	\$ 1.99
PUR:V2821A	OIL FILTER..1 EACH	\$ 3.39
PUR:V4006	OIL FILTER..1 EACH	\$ 2.09
PUR:V4011	OIL FILTER..1 EACH	\$ 2.16
PUR:V4457	OIL FILTER..1 EACH	\$ 2.09
PUR:V4459	OIL FILTER..1 EACH	\$ 2.65
PUR:V4460	OIL FILTER..1 EACH	\$ 2.79
PUR:V4466	OIL FILTER..1 EACH	\$ 4.47
PUR:V4476	OIL FILTER..1 EACH	\$ 2.09
PUR:V4477	OIL FILTER..1 EACH	\$ 3.55
PUR:V4484	OIL FILTER..1 EACH	\$ 4.99
PUR:V4612	OIL FILTER..1 EACH	\$ 3.19
PUR:V4619	OIL FILTER..1 EACH	\$ 3.19
PUR:V4622	OIL FILTER..1 EACH	\$ 2.87
PUR:V4631	OIL FILTER..1 EACH	\$ 2.24
PUR:V4651	OIL FILTER..1 EACH	\$ 2.87
PUR:V4670	OIL FILTER..1 EACH	\$ 2.87
PUR:V4872	OIL FILTER..1 EACH	\$ 10.67
PUR:V5230	OIL FILTER..1 EACH	\$ 4.70
PUR:V5274	OIL FILTER..1 EACH	\$ 3.30
PUR:V5288	OIL FILTER..1 EACH	\$ 2.99
PUR:V5309	OIL FILTER..1 EACH	\$ 5.70
PUR:V5313	OIL FILTER..1 EACH	\$ 3.81
PUR:V5315	OIL FILTER..1 EACH	\$ 7.98
PUR:V5399	OIL FILTER..1 EACH	\$ 3.65
PUR:V5436	OIL FILTER..1 EACH	\$ 4.70
PUR:V5608	OIL FILTER..1 EACH	\$ 5.55
PUR:V5610	OIL FILTER..1 EACH	\$ 5.97



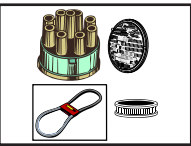

AUTOMOTIVE PARTS

FILTERS

Group 7 Air Filters

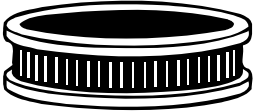
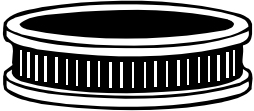
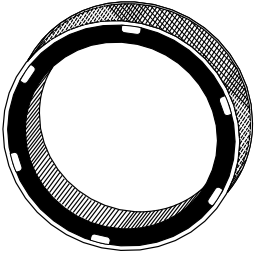

PUR:VA4656	AIR FILTER..1 EACH	\$ 6.20
PUR:VA4669	AIR FILTER..1 EACH	\$ 8.60
PUR:VA4680	AIR FILTER..1 EACH	\$ 9.19
PUR:VA4690	AIR FILTER..1 EACH	\$ 9.00
PUR:VA4712	AIR FILTER..1 EACH	\$ 3.84
PUR:VA4715	AIR FILTER..1 EACH	\$ 5.80
PUR:VA4720	AIR FILTER..1 EACH	\$ 8.82
PUR:VA4721	AIR FILTER..1 EACH	\$ 12.05
PUR:VA4722	AIR FILTER..1 EACH	\$ 9.06
PUR:VA4727	AIR FILTER..1 EACH	\$ 8.58
PUR:VA4731	AIR FILTER..1 EACH	\$ 7.57
PUR:VA4799	AIR FILTER..1 EACH	\$ 13.88
PUR:VA4831	AIR FILTER..1 EACH	\$ 7.68
PUR:VA4832	AIR FILTER..1 EACH	\$ 9.75
PUR:VA4873	AIR FILTER..1 EACH	\$ 14.12
PUR:VA4878	AIR FILTER..1 EACH	\$ 9.47
PUR:VA4879	AIR FILTER..1 EACH	\$ 6.68
PUR:VA4880	AIR FILTER..1 EACH	\$ 4.65
PUR:VA4881	AIR FILTER..1 EACH	\$ 6.19
PUR:VA4886	AIR FILTER..1 EACH	\$ 13.70
PUR:VA5048	AIR FILTER..1 EACH	\$ 5.13
PUR:VA5090	AIR FILTER..1 EACH	\$ 10.61
PUR:VA5148	AIR FILTER..1 EACH	\$ 7.71
PUR:VA5155	AIR FILTER..1 EACH	\$ 10.75
PUR:VA5192	AIR FILTER..1 EACH	\$ 7.46
PUR:VA5248	AIR FILTER..1 EACH	\$ 14.48
PUR:VA5265	AIR FILTER..1 EACH	\$ 7.13
PUR:VA5314	AIR FILTER..1 EACH	\$ 14.34
PUR:VA5323	AIR FILTER..1 EACH	\$ 6.05
PUR:VA5324	AIR FILTER..1 EACH	\$ 9.62
PUR:VA5396	AIR FILTER..1 EACH	\$ 4.80
PUR:VA5397	AIR FILTER..1 EACH	\$ 9.62
PUR:VA5400	AIR FILTER..1 EACH	\$ 9.71
PUR:VA5418	AIR FILTER..1 EACH	\$ 5.88
PUR:VA5432	AIR FILTER..1 EACH	\$ 6.11
PUR:VA6097	AIR FILTER..1 EACH	\$ 11.08
PUR:A25352	AIR FILTER..1 EACH	\$ 12.40
PUR:A35414	AIR FILTER..1 EACH	\$ 7.60
PUR:A44646	AIR FILTER..1 EACH	\$ 22.63
PUR:A50831	AIR FILTER..1 EACH	\$ 7.03

Group 7 Fuel Filters

PUR:GF470	FUEL FILTER..1 EACH	\$ 1.99
PUR:FG800	FUEL FILTER..1 EACH	\$ 3.19
PUR:G3727	FUEL FILTER..1 EACH	\$ 2.53
PUR:G3802	FUEL FILTER..1 EACH	\$ 3.19
PUR:G3850	FUEL FILTER..1 EACH	\$ 6.41
PUR:G6348	FUEL FILTER..1 EACH	\$ 3.19
PUR:G6462	FUEL FILTER..1 EACH	\$ 3.19
PUR:G7196	FUEL FILTER..1 EACH	\$ 3.19
PUR:G7333	FUEL FILTER..1 EACH	\$ 7.21
PUR:F10013	FUEL FILTER..1 EACH	\$ 2.29
PUR:F10021	FUEL FILTER..1 EACH	\$ 1.63
PUR:F10024	FUEL FILTER..1 EACH	\$ 2.25
PUR:F10119	FUEL FILTER..1 EACH	\$ 0.80
PUR:F20036	FUEL FILTER..1 EACH	\$ 3.33
PUR:F20247	FUEL FILTER..1 EACH	\$ 2.58
PUR:F20265	FUEL FILTER..1 EACH	\$ 3.58
PUR:F23162	FUEL FILTER..1 EACH	\$ 3.33

Group 7 Transmission Filters

PUR:P227	TRANSMISSION FILTER..1 EACH	\$ 3.68
PUR:P235	TRANSMISSION FILTER..1 EACH	\$ 5.83
PUR:P236	TRANSMISSION FILTER..1 EACH	\$ 14.22
PUR:P241	TRANSMISSION FILTER..1 EACH	\$ 5.42
PUR:P255	TRANSMISSION FILTER..1 EACH	\$ 7.86

Parker Brothers
gladly accepts
Visa, Mastercard
Discover &
American Express



AUTOMOTIVE PARTS

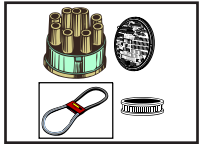

FILTERS

Group 7 Air Filters

PUR:VA4	AIR FILTER..1 EACH	\$ 3.24
PUR:VA52	AIR FILTER..1 EACH	\$ 3.58
PUR:VA57	AIR FILTER..1 EACH	\$ 3.50
PUR:VA59	AIR FILTER..1 EACH	\$ 3.70
PUR:FB59	BREATHER ELEMENT..1EACH	\$ 1.12
PUR:FB87	BREATHER ELEMENT..1EACH	\$ 1.12
PUR:VA67	AIR FILTER..1 EACH	\$ 3.12
PUR:VA74	AIR FILTER..1 EACH	\$ 4.68
PUR:VA83	AIR FILTER..1 EACH	\$ 4.33
PUR:VA90	AIR FILTER..1 EACH	\$ 3.50
PUR:VA91	AIR FILTER..1 EACH	\$ 3.34
PUR:VA92	AIR FILTER..1 EACH	\$ 3.42
PUR:VA110	AIR FILTER..1 EACH	\$ 4.16
PUR:VA113	AIR FILTER..1 EACH	\$ 3.42
PUR:VA1149	AIR FILTER..1 EACH	\$ 5.03
PUR:VA120	AIR FILTER..1 EACH	\$ 4.34
PUR:VA124	AIR FILTER..1 EACH	\$ 4.02
PUR:VA3137	AIR FILTER..1 EACH	\$ 3.50
PUR:VA3138	AIR FILTER..1 EACH	\$ 3.50
PUR:VA3149	AIR FILTER..1 EACH	\$ 4.74
PUR:VA3192	AIR FILTER..1 EACH	\$ 3.53
PUR:VA3195	AIR FILTER..1 EACH	\$ 3.84
PUR:VA3196	AIR FILTER..1 EACH	\$ 3.19
PUR:VA3357	AIR FILTER..1 EACH	\$ 3.78
PUR:VA3380	AIR FILTER..1 EACH	\$ 3.19
PUR:VA3384	AIR FILTER..1 EACH	\$ 5.03
PUR:VA3398	AIR FILTER..1 EACH	\$ 4.87
PUR:VA3426	AIR FILTER..1 EACH	\$ 3.58
PUR:VA3436	AIR FILTER..1 EACH	\$ 3.50
PUR:VA3465	AIR FILTER..1 EACH	\$ 3.90
PUR:VA3466	AIR FILTER..1 EACH	\$ 5.88
PUR:VA3467	AIR FILTER..1 EACH	\$ 5.88
PUR:VA3472	AIR FILTER..1 EACH	\$ 4.37
PUR:VA3474	AIR FILTER..1 EACH	\$ 3.68
PUR:VA3538	AIR FILTER..1 EACH	\$ 4.54
PUR:VA3590	AIR FILTER..1 EACH	\$ 4.22
PUR:VA3591	AIR FILTER..1 EACH	\$ 4.04
PUR:VA3592	AIR FILTER..1 EACH	\$ 4.22
PUR:VA3593	AIR FILTER..1 EACH	\$ 5.75
PUR:VA4278	AIR FILTER..1 EACH	\$ 6.17
PUR:VA4279	AIR FILTER..1 EACH	\$ 5.88
PUR:VA4297	AIR FILTER..1 EACH	\$ 9.06
PUR:VA4327	AIR FILTER..1 EACH	\$ 3.84
PUR:VA4342	AIR FILTER..1 EACH	\$ 4.94
PUR:VA4343	AIR FILTER..1 EACH	\$ 4.12
PUR:VA4346	AIR FILTER..1 EACH	\$ 4.37
PUR:VA4347	AIR FILTER..1 EACH	\$ 4.73
PUR:VA4361	AIR FILTER..1 EACH	\$ 8.34
PUR:VA4372	AIR FILTER..1 EACH	\$ 5.31
PUR:VA4375	AIR FILTER..1 EACH	\$ 9.53
PUR:VA4378	AIR FILTER..1 EACH	\$ 4.58
PUR:VA4379	AIR FILTER..1 EACH	\$ 4.47
PUR:VA4467	AIR FILTER..1 EACH	\$ 10.72
PUR:VA4470	AIR FILTER..1 EACH	\$ 5.74
PUR:VA4479	AIR FILTER..1 EACH	\$ 5.68
PUR:VA4487	AIR FILTER..1 EACH	\$ 9.81
PUR:VA4490	AIR FILTER..1 EACH	\$ 8.93
PUR:VA4601	AIR FILTER..1 EACH	\$ 10.73
PUR:VA4610	AIR FILTER..1 EACH	\$ 5.74
PUR:VA4613	AIR FILTER..1 EACH	\$ 9.40
PUR:VA4632	AIR FILTER..1 EACH	\$ 6.41
PUR:VA4633	AIR FILTER..1 EACH	\$ 6.66
PUR:VA4636	AIR FILTER..1 EACH	\$ 5.40
PUR:VA4645	AIR FILTER..1 EACH	\$ 8.96
PUR:VA4650	AIR FILTER..1 EACH	\$ 8.84

AUTOMOTIVE PARTS

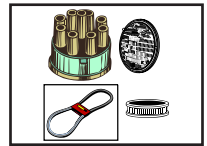

FILTERS

Group 7 Transmission Filters

PUR:P 256	TRANSMISSION FILTER..1 EACH	\$ 6.74
PUR:P 1150	TRANSMISSION FILTER..1 EACH	\$ 9.21
PUR:P 1151	TRANSMISSION FILTER..1 EACH	\$ 6.57
PUR:P 1153	TRANSMISSION FILTER..1 EACH	\$ 17.96
PUR:P 1173	TRANSMISSION FILTER..1 EACH	\$ 19.04
PUR:P 1185	TRANSMISSION FILTER..1 EACH	\$ 13.53
PUR:P 1195	TRANSMISSION FILTER..1 EACH	\$ 11.73

BALDWIN FILTERS

Baldwin is a true filter manufacturer. The competition assembles filter parts. Baldwin produces one of the highest percentages of their own filter parts in the industry. Producing their own parts, using the best raw materials, and many exclusive innovations make Baldwin the premier heavy duty filter. To follow is a list of Baldwin's "A" movers. For a complete Baldwin price sheet, ask your sales representative.

Baldwin Oil Filters

BMC:B2	\$ 4.58
BMC:B6	\$ 5.28
BMC:B7	\$ 10.89
BMC:P20HD	\$ 6.87
BMC:B27	\$ 5.15
BMC:B35S	\$ 5.42
BMC:B43S	\$ 4.92
BMC:B76	\$ 8.62
BMC:B95	\$ 16.99
BMC:B96	\$ 18.51
BMC:B99	\$ 17.38
BMC:BD103	\$ 32.50
BMC:BC110	\$ 16.76
BMC:B113	\$ 6.47
BMC:B134	\$ 10.71
BMC:B161S	\$ 6.46
BMC:B227	\$ 6.87
BMC:BT230	\$ 4.85
BMC:B233	\$ 5.24
BMC:B243	\$ 6.02
BMC:BT259	\$ 5.91
BMC:BT261	\$ 8.37
BMC:BT287	\$ 12.43
BMC:B329	\$ 6.41
BMC:C750-e	\$ 11.04
BMC:BT339	\$ 7.54
BMC:BT364	\$ 6.73
BMC:B495	\$ 17.38
BMC:PT670	\$ 7.30
BMC:B1428	\$ 5.20
BMC:P7003	\$ 33.08
BMC:B7600	\$ 10.16

Baldwin Air Filters

BMC:PA1902FN	\$ 40.91
BMC:PA1911	\$ 27.50
BMC:PA2008	\$ 7.39
BMC:PA2092	\$ 14.32
BMC:PA2150	\$ 9.67
BMC:PA2152	\$ 9.04
BMC:SA2159	\$ 5.36
BMC:PA2164	\$ 9.86
BMC:PA2233	\$ 25.78
BMC:PA2237	\$ 13.20
BMC:PA2312	\$ 49.54
BMC:PA2317	\$ 58.50
BMC:PA2333	\$ 65.01
BMC:PA2358	\$ 46.05
BMC:PA2360FN	\$ 28.05
BMC:PA2418FN	\$ 35.43
BMC:PA2419	\$ 23.33
BMC:PA2425	\$ 57.29
BMC:PA2438	\$ 49.33
BMC:PA2487	\$ 19.99
BMC:PA2500	\$ 66.97
BMC:PA2501	\$ 67.59
BMC:PA2521	\$ 47.48
BMC:PA2575	\$ 35.25
BMC:PA2642	\$ 79.33
BMC:PA2661	\$ 65.04
BMC:PA2680	\$ 85.96
BMC:LL2685	\$ 72.71
BMC:PA2704	\$ 76.84
BMC:PA2705	\$ 65.87
BMC:PA2729	\$ 79.83
BMC:PA2804	\$ 42.37
BMC:RS2863	\$ 33.88
BMC:RS3501	\$ 24.60
BMC:RS3504	\$ 45.88
BMC:RS3508	\$ 52.04
BMC:RS3516	\$ 75.30
BMC:RS3518	\$ 69.68
BMC:RS3530	\$ 61.50
BMC:RS3544	\$ 39.52
BMC:RS3548	\$ 54.74
BMC:RS3707	\$ 21.23
BMC:PA4075	\$ 15.84

Baldwin Fuel Filters

BMC:PF10	\$ 5.99
BMC:BF584	\$ 12.62
BMC:BF588	\$ 10.79
BMC:BF614	\$ 10.16
BMC:BF788	\$ 8.29
BMC:BF790	\$ 8.99
BMC:BF825	\$ 5.87
BMC:BF840K1	\$ 4.04
BMC:BF853	\$ 11.99
BMC:BF876	\$ 8.93
BMC:BF877	\$ 8.71
BMC:BF909	\$ 12.04
BMC:BF954	\$ 7.61
BMC:BF957	\$ 6.29
BMC:BF970	\$ 7.11
BMC:BF971	\$ 8.38
BMC:BF976	\$ 12.53
BMC:BF979	\$ 8.75
BMC:BF988	\$ 7.87
BMC:BF1166	\$ 9.11
BMC:BF1201	\$ 20.51
BMC:BF1212	\$ 13.87
BMC:BF1226	\$ 12.10
BMC:BF1257	\$ 14.70

Baldwin Fuel Filters

BMC:BF1259	\$ 14.88
BMC:BF1280	\$ 8.90
BMC:BF5800	\$ 8.53
BMC:BF5810	\$ 8.45
BMC:BF7557	\$ 8.29
BMC:BF7587	\$ 14.79
BMC:BF7632	\$ 12.79
BMC:BF7633	\$ 9.97

Baldwin Hydraulic Filters

BMC:PT90-10	\$ 11.60
BMC:PT189	\$ 9.80
BMC:BT287-10	\$ 12.72
BMC:BT839	\$ 7.71
BMC:BT839-10	\$ 7.16

Baldwin Coolant Filters

BMC:BW5071	\$ 11.70
BMC:BW5137	\$ 11.39
BMC:BW5139	\$ 18.12
BMC:BW5178	\$ 10.46
BMC:BW5179	\$ 22.03

Baldwin Air Filters

BMC:PA1615	\$ 38.53
BMC:PA1634	\$ 39.12
BMC:PA1637FN	\$ 38.38
BMC:PA1667FN	\$ 17.13
BMC:PA1681FN	\$ 18.25
BMC:PA1690FN	\$ 18.05
BMC:PA1704	\$ 4.95
BMC:PA1712	\$ 6.30
BMC:PA1865FN	\$ 14.49
BMC:PA1884	\$ 38.67
BMC:PA1885	\$ 42.22
BMC:PA1893	\$ 31.24



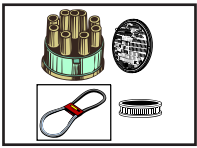

AUTOMOTIVE PARTS

GATES PRODUCTS

Gates Safety Strip Heater Hose

These premium hoses are designed for long service life. They resist deterioration from most coolants, non-oil based coolant additives, high temperatures, and high pressure. Temperature Rating 40F - 257F

GAT:28409	SAFETY STRIPE HEATER HOSE..3/8" X 50'	\$ 32.70
GAT:28410	SAFETY STRIPE HEATER HOSE..1/2" X 50'	\$ 37.35
GAT:28411	SAFETY STRIPE HEATER HOSE..5/8" X 50'	\$ 41.52
GAT:28412	SAFETY STRIPE HEATER HOSE..3/4" X 50'	\$ 54.22
GAT:28413	SAFETY STRIPE HEATER HOSE..1" X 50'	\$ 73.80

Gates Charter Heater Hose

These economical hoses are designed for reliability. They resist deterioration from most coolants, non-oil based coolant additives, high temperatures, and high pressure. Temperature Rating 40F - 257F

GAT:28407	CHARTER HEATER HOSE..1/4" X 50'	\$ 19.89
GAT:28400	CHARTER HEATER HOSE..1/2" X 50'	\$ 30.60
GAT:28401	CHARTER HEATER HOSE..5/8" X 50'	\$ 30.50
GAT:28402	CHARTER HEATER HOSE..3/4" X 50'	\$ 37.06

Gates Safety Stripe 2 Fuel Line/PCV/Evaporative Emission Control Hose

These reinforced multi-purpose hoses can be used as fuel lines, PCV and EEC systems, and for fuel return hose connections on diesel fuel injection systems. They are approved for use with leaded and unleaded gasoline, diesel and gasoline blends of ethanol, methanol, and ether. DO NOT use for pressure line on fuel injected engines (use MPI/Fuel Injection Hose) or for coolant applications.

GAT:27000	FUEL LINE/PVC/EMISSION HOSE..1/8" X 25'	\$ 22.25
GAT:27001	FUEL LINE/PVC/EMISSION HOSE..3/16" X 25'	\$ 22.68
GAT:27002	FUEL LINE/PVC/EMISSION HOSE..1/4" X 25'	\$ 20.07
GAT:27003	FUEL LINE/PVC/EMISSION HOSE..5/16" X 25'	\$ 20.30
GAT:27004	FUEL LINE/PVC/EMISSION HOSE..3/8" X 25'	\$ 31.08
GAT:27005	FUEL LINE/PVC/EMISSION HOSE..7/16" X 25'	\$ 22.25
GAT:27006	FUEL LINE/PVC/EMISSION HOSE..1/2" X 25'	\$ 45.04
GAT:27045	WINDSHIELD WASH/VACUUM TUBING..3/32" X 50'	\$ 11.28
GAT:27041	WINDSHIELD WASH/VACUUM TUBING..7/64" X 50'	\$ 12.08
GAT:27042	WINDSHIELD WASH/VACUUM TUBING..5/32" X 50'	\$ 17.05
GAT:27043	WINDSHIELD WASH/VACUUM TUBING..7/32" X 50'	\$ 18.70
GAT:27044	WINDSHIELD WASH/VACUUM TUBING..1/4" X 50'	\$ 20.60
GAT:27050	WINDSHIELD WASH/VACUUM TUBING..5/16" X 25'	\$ 13.60

Gates Transmission Cooler Line

This hose provides a safe heat and oil resistant connecting line between the oil cooler and the transmission. It has one fiber braid reinforcement over an oil resistant nitrile rubber tube. It has an oil and abrasion resistant Hypalon cover. Meets or exceeds SAE J1019 requirements. Temperature Range - +300F.

GAT:27058	TRANSMISSION OIL COOLER HOSE..5/16" X 25'	\$ 51.48
GAT:27059	TRANSMISSION OIL COOLER HOSE..3/8" X 25'	\$ 58.31
GAT:27067	TRANSMISSION OIL COOLER HOSE..1/2" X 50'	\$ 128.52

Gates MPI/Fuel Injection Hose

This hose is recommended for all clamped hose applications on fuel systems, including fuel injection engines. It is NOT designed to replace coupled hose assemblies on fuel injection systems. It is approved for leaded and unleaded gasoline, diesel and gasoline blends of ethanol, methanol, and ethers, and 100% methanol or ethanol. It has Hypalon tubes to combat heat, and reinforced braid Polyester to increase strength. Temperature Range - +300F.

GAT:27082	FUEL INJECTION HOSE..1/4" X 10'	\$ 43.50
GAT:27085	FUEL INJECTOR HOSE..5/16" X 10'	\$ 50.92
GAT:27095	FUEL INJECTOR HOSE..5/16" X 25'	\$ 105.75
GAT:27096	FUEL INJECTION HOSE..3/8" X 25'	\$ 119.48

Gates Multi-Purpose Hose

This hose is designed for handling low pressure air, water, agricultural spraying, oil or grease. It has Nitrile tube and cover to resist oil. Temperature Range 0F - 212F

GAT:27410	MULTI-USE HOSE..1/2" X 50'	\$ 128.69
GAT:27414	MULTI-USE HOSE..5/8" X 50'	\$ 132.63
GAT:27418	MULTI-USE HOSE..3/4" X 50'	\$ 160.48

AUTOMOTIVE PARTS

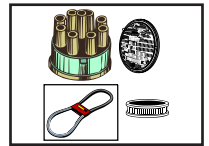

GATES PRODUCTS

Gates Fuel Fill Hose

This hose is designed for transferring fuel from vehicle's filler neck to fuel tank. It works on passenger cars, light trucks, and recreational vehicles. It is for use with most types of fuel. It is especially resistant to gasoline and diesel fuel. Temperature Range - +250F.

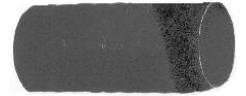

GAT:23924	FUEL FILL HOSE..1 EACH	\$ 43.84
GAT:23932	FUEL FILL HOSE..1 EACH	\$ 48.05
GAT:23964	FUEL FILL HOSE..1 EACH	\$ 27.49
GAT:23972	FUEL FILL HOSE..1 EACH	\$ 37.47

Gates XL V-Belts

These belts are replacement belts for today's most demanding engine drives. Their exclusive silencer variable notch design breaks up harmonics, so the XL belt runs quieter. Their fiber loaded rubber stock puts more flexibility along the length of the belt, yet gives you greater lateral stability in the pulley. Thermal active tensional cords provide maintenance free performance when properly installed and tensioned. The Aramid fiber notches are self lubricating allowing the belt to enter and exit the pulley quicker, smoother, and quieter than traditional v-belts. These belts automatically adjust for tension loss through age and wear. Parker Brothers is proud to provide the complete line of Gates XL V-Belts. To follow is a list of the top 13 Gates XL V-Belts.

GAT:7345	AUTOMOTIVE XL V-BELT..1 EACH	\$ 8.80
GAT:7355	AUTOMOTIVE XL V-BELT..1 EACH	\$ 8.89
GAT:7365	AUTOMOTIVE XL V-BELT..1 EACH	\$ 8.39
GAT:7375	AUTOMOTIVE XL V-BELT..1 EACH	\$ 9.16
GAT:7380	AUTOMOTIVE XL V-BELT..1 EACH	\$ 9.19
GAT:7405	AUTOMOTIVE XL V-BELT..1 EACH	\$ 9.92
GAT:7430	AUTOMOTIVE XL V-BELT..1 EACH	\$ 9.77
GAT:7435	AUTOMOTIVE XL V-BELT..1 EACH	\$ 9.80
GAT:7440	AUTOMOTIVE XL V-BELT..1 EACH	\$ 9.84
GAT:7445	AUTOMOTIVE XL V-BELT..1 EACH	\$ 9.23
GAT:7448	AUTOMOTIVE XL V-BELT..1 EACH	\$ 10.04
GAT:7450	AUTOMOTIVE XL V-BELT..1 EACH	\$ 10.12
GAT:7460	AUTOMOTIVE XL V-BELT..1 EACH	\$ 10.06



Gates Micro V-Belts

These belts are for replacing original belts on serpentine drives and other V-ribbed belt applications. They are designed for small diameter pulleys, backside idlers, and for use with or without automatic tensioners. They have application specific belt construction which eliminates belt noise, reduces tension loss, and solves problem drive applications. Special tensile members and fibre loaded reinforcement of ribs give these belts extra resistance to wear and cracking. Parker Brothers is proud to provide the complete line of Gates Micro V-Belts. To follow is a list of the top 12 Gates Micro V-Belts

GAT:K030300	AUTOMOTIVE MICRO V BELT..1 EACH	\$ 7.96
GAT:K040233	AUTOMOTIVE MICRO V BELT..1 EACH	\$ 7.25
GAT:K040320	AUTOMOTIVE MICRO V BELT..1 EACH	\$ 9.51
GAT:K040365	AUTOMOTIVE MICRO V BELT..1 EACH	\$ 11.07
GAT:K040384	AUTOMOTIVE MICRO V BELT..1 EACH	\$ 8.68
GAT:K050420	AUTOMOTIVE MICRO V BELT..1 EACH	\$ 14.57
GAT:K050435	AUTOMOTIVE MICRO V BELT..1 EACH	\$ 24.43
GAT:K060695	AUTOMOTIVE MICRO V BELT..1 EACH	\$ 25.70
GAT:K060710	AUTOMOTIVE MICRO V BELT..1 EACH	\$ 21.40
GAT:K060868	AUTOMOTIVE MICRO V BELT..1 EACH	\$ 34.66
GAT:K060870	AUTOMOTIVE MICRO V BELT..1 EACH	\$ 26.81
GAT:K060910	AUTOMOTIVE MICRO V BELT..1 EACH	\$ 34.75

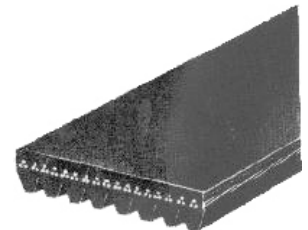

14-21

(770)474-1286

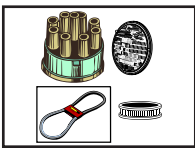

AUTOMOTIVE PARTS

STANT THERMOSTATS AND CAPS

Stant is the leader in the field of thermostats and caps. They use the best raw materials, the last technology, and many new innovations to provide the highest quality product possible. Parker Brothers is proud to offer the complete Stant product line. To follow are lists of the top thermostats, oil filler caps, gas caps, and radiator



Stant Thermostats

66% coverage

STA:13006	THERMOSTAT	\$ 2.49
STA:13008	THERMOSTAT	\$ 2.49
STA:13009	THERMOSTAT	\$ 2.49
STA:13358	THERMOSTAT	\$ 4.42
STA:13359	THERMOSTAT	\$ 4.40
STA:13789	THERMOSTAT	\$ 4.06
STA:13829	THERMOSTAT	\$ 5.86
STA:13849	THERMOSTAT	\$ 4.11
STA:13869	THERMOSTAT	\$ 7.08
STA:13899	THERMOSTAT	\$ 5.34

Stant Oil Filler Caps

75% coverage

STA:10061	OIL FILLER CAP	\$ 4.05
STA:10064	OIL FILLER CAP	\$ 3.78
STA:10066	OIL FILLER CAP	\$ 1.47
STA:10071	OIL FILLER CAP	\$ 4.79
STA:10072	OIL FILLER CAP	\$ 1.75
STA:10075	OIL FILLER CAP	\$ 4.77
STA:10079	OIL FILLER CAP	\$ 3.78
STA:10081	OIL FILLER CAP	\$ 4.06
STA:10088	OIL FILLER CAP	\$ 7.27
STA:10105	OIL FILLER CAP	\$ 3.69



Stant Gas Caps

86% coverage

STA:10623	GAS CAP	\$ 5.01
STA:10800	GAS CAP	\$ 7.74
STA:10806	GAS CAP	\$ 5.70
STA:10810	GAS CAP	\$ 4.15
STA:10811	GAS CAP	\$ 7.87
STA:10817	GAS CAP	\$ 6.77
STA:10818	GAS CAP	\$ 6.00
STA:10819	GAS CAP	\$ 8.15
STA:10825	GAS CAP	\$ 5.82
STA:10826	GAS CAP	\$ 6.01



Stant Radiator Caps

95% coverage

STA:10208	RADIATOR CAP	\$ 3.84
STA:10227	RADIATOR CAP	\$ 9.64
STA:10228	RADIATOR CAP	\$ 4.09
STA:10229	RADIATOR CAP	\$ 4.14
STA:10230	RADIATOR CAP	\$ 4.14
STA:10231	RADIATOR CAP	\$ 4.14
STA:10232	RADIATOR CAP	\$ 5.89
STA:10233	RADIATOR CAP	\$ 7.27
STA:10237	RADIATOR CAP	\$ 3.80
STA:10282	RADIATOR CAP	\$ 4.74



AUTOMOTIVE PARTS

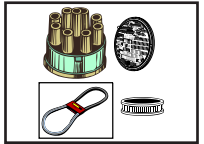

MUFFLER CLAMPS

Muffler Clamps

M/C:1-1/2-S	STANDARD DUTY MUFFLER CLAMP	\$ 0.65
M/C:1-3/4-S	STANDARD DUTY MUFFLER CLAMP	\$ 0.65
M/C:1-3/4HD-GM	HEAVY DUTY MUFFLER CLAMP	\$ 0.99
M/C:1-5/8-S	STANDARD DUTY MUFFLER CLAMP	\$ 1.00
M/C:1-7/8-S	STANDARD DUTY MUFFLER CLAMP	\$ 0.65
M/C:1-7/8HD-GM	HEAVY DUTY MUFFLER CLAMP	\$ 0.99
M/C:2HD-GM	HEAVY DUTY MUFFLER CLAMP	\$ 1.38
M/C:2-1/8-S	STANDARD DUTY MUFFLER CLAMP	\$ 0.78
M/C:2-1/4-S	STANDARD DUTY MUFFLER CLAMP	\$ 0.78
M/C:2-1/4HD-GM	HEAVY DUTY MUFFLER CLAMP	\$ 1.12
M/C:2-1/2-S	STANDARD DUTY MUFFLER CLAMP	\$ 0.78
M/C:2-1/2HD-GM	HEAVY DUTY MUFFLER CLAMP	\$ 1.12
M/C:2-3/4HD-GM	HEAVY DUTY MUFFLER CLAMP	\$ 2.14
M/C:3-1/2HD-GM	HEAVY DUTY MUFFLER CLAMP	\$ 2.54
M/C:3HD-GM	HEAVY DUTY MUFFLER CLAMP	\$ 2.14
M/C:4HD-GM	HEAVY DUTY MUFFLER CLAMP	\$ 8.66
M/C:5HD-GM	HEAVY DUTY MUFFLER CLAMP	\$ 3.75
M/C:TPH1	UNIVERSAL MUFFLER HANGER	\$ 1.88

FOR 50+ YEARS,
PARKER
BROTHERS
HAS BEEN
SERVING ATLANTA.
THANK YOU FOR
YOUR CONTINUED
SUPPORT!!

BATTERIES

Batteries

BAT:I45	12 VOLT AUTOMOTIVE BATTERY..1 EACH	\$ 82.95
BAT:MT-24	12 VOLT AUTOMOTIVE BATTERY..1 EACH	\$ 110.92
BAT:MT-24F	12 VOLT AUTOMOTIVE BATTERY..1 EACH	\$ 133.42
BAT:MT-26R	12 VOLT AUTOMOTIVE BATTERY..1 EACH	\$ 101.93
BAT:MT-34	12 VOLT AUTOMOTIVE BATTERY..1 EACH	\$ 113.92
BAT:MT-35	12 VOLT AUTOMOTIVE BATTERY..1 EACH	\$ 95.58
BAT:MT-51	12 VOLT AUTOMOTIVE BATTERY..1 EACH	\$ 107.92
BAT:MT-51R	12 VOLT AUTOMOTIVE BATTERY..1 EACH	\$ 107.92
BAT:MT-58	12 VOLT AUTOMOTIVE BATTERY..1 EACH	\$ 97.50
BAT:MT-58R	12 VOLT AUTOMOTIVE BATTERY..1 EACH	\$ 92.89
BAT:MT-65	12 VOLT AUTOMOTIVE BATTERY..1 EACH	\$ 159.53
BAT:MT-75	12 VOLT AUTOMOTIVE BATTERY..1 EACH	\$ 117.67
BAT:MT-75DT	12 VOLT AUTOMOTIVE BATTERY..1 EACH	\$ 98.92
BAT:MT-78	12 VOLT AUTOMOTIVE BATTERY..1 EACH	\$ 165.22
BAT:MT-85	12 VOLT AUTOMOTIVE BATTERY..1 EACH	\$ 86.16
BAT:MT-24	12 VOLT AUTOMOTIVE BATTERY..1 EACH	\$ 125.92
BAT:MT-24F	12 VOLT AUTOMOTIVE BATTERY..1 EACH	\$ 125.92
BAT:MT-27	12 VOLT AUTOMOTIVE BATTERY..1 EACH	\$ 143.88
BAT:MT-27F	12 VOLT AUTOMOTIVE BATTERY..1 EACH	\$ 118.43
BAT:MT-40R	12 VOLT AUTOMOTIVE BATTERY..1 EACH	\$ 116.93
BAT:MT-65	12 VOLT AUTOMOTIVE BATTERY..1 EACH	\$ 178.27
BAT:SC34DU	12 VOLT AUTOMOTIVE BATTERY..1 EACH	\$ 254.00
BAT:1151	12 VOLT COMMERCIAL BATTERY..1 EACH	\$ 143.57
BAT:31-MHD	12 VOLT COMMERCIAL BATTERY..1 EACH	\$ 170.92
BAT:31P-MHD	12 VOLT COMMERCIAL BATTERY..1 EACH	\$ 157.02
BAT:ADRY0070	12 VOLT MOTORCYCLE BATTERY..1 EACH	\$ 34.95
BAT:CTB16-B	12 VOLT MOTORCYCLE BATTERY..1 EACH	\$ 67.00
BAT:CYHD-12	12 VOLT MOTORCYCLE BATTERY..1 EACH	\$ 81.83
BAT:CYTX20L-BS	12 VOLT MOTORCYCLE BATTERY..1 EACH	\$ 93.98
BAT:CYTX5L-BS	12 VOLT MOTORCYCLE BATTERY..1 EACH	\$ 74.25
BAT:YB16-B	12 VOLT MOTORCYCLE BATTERY..1 EACH	\$ 77.70
BAT:YTX20HBS	12 VOLT MOTORCYCLE BATTERY..1 EACH	\$ 94.99
BAT:SP-30	12 VOLT SPECIAL USE BATTERY..1 EACH	\$ 69.83
BAT:SP-30R	12 VOLT SPECIAL USE BATTERY..1 EACH	\$ 70.43
BAT:SRM-24	12 VOLT SPECIAL USE BATTERY..1 EACH	\$ 103.43
BAT:SRM-27	12 VOLT SPECIAL USE BATTERY..1 EACH	\$ 145.42

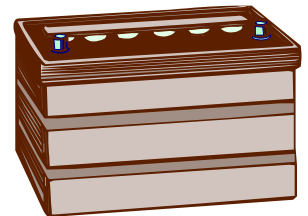
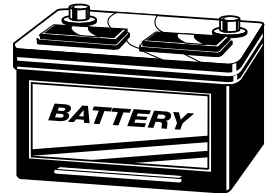

AUTOMOTIVE PARTS

DRAIN PLUGS AND GASKETS

Drain Plug Gaskets

TMR:DP7515	1/2" FIBER GASKET..1 EACH	\$ 0.10
TMR:DP7515G	1/2" GREEN SYNTHETIC FIBER GASKET..100 PER BAG	\$ 43.50
TMR:DP7526	1/2" SINGLE OVERSIZED FIBER GASKET..100 PER BAG	\$ 7.50
TMR:DP7408	12MM GM METAL/RUBBER DRAIN PLUG GASKET..1 EACH	\$ 0.77
TMR:DP7125	12MM ALUMINUM GASKET..100 PER BAG	\$ 0.33
TMR:DP7406	12MM SATURN RUBBER DRAIN PLUG GASKET..1 EACH	\$ 0.60
TMR:DP7407	12MM GM RUBBER DRAIN PLUG GASKET..1 EACH	\$ 0.61
TMR:DP7525S	12MM DOUBLE THICK FIBER GASKET..100 PER BAG	\$ 7.50
TMR:DP7161S	14MM ALUMINUM GASKET..1 EACH	\$ 0.20
TMR:DP5	14MM CRUSHABLE COPPER GASKET..1 EACH	\$ 0.50
TMR:DP7409	14MM FORD METAL/RUBBER DRAIN PLUG GASKET..1 EACH	\$ 0.53
TMR:DP7501	14MM FIBER GASKET..1 EACH	\$ 0.10
TMR:DP7101S	14MM ALUMINUM GASKET DEAD SOFT..100 PER BAG	\$ 0.34
TMR:DP7501G	14MM GREEN SYNTHETIC FIBER GASKET..100 PER BAG	\$ 39.00
TMR:DP6939X	16MM CRUSHABLE COPPER GASKET..1 EACH	\$ 0.39
TMR:DP7539X	16MM FIBER GASKET..100 PER BAG	\$ 7.50

Drain Plugs

TMR:DP7715	1/2"-20 DOG POINT DRAIN PLUG..1 EACH	\$ 0.41
TMR:DP7716	1/2"-20 REGULAR POINT ZINC PLATED DRAIN PLUG..1 EACH	\$ 0.80
TMR:DP7717	1/2"-20 REGULAR POINT PLAIN FINISH DRAIN PLUG..1 EACH	\$ 1.00
TMR:DP7727SK	1/2"-20 DOUBLE OVERSIZED DRAIN PLUG..1 EACH	\$ 1.24
TMR:DP7801	1/2"-20 DRAIN PLUG DRAIN PLUG..1 EACH	\$ 1.60
TMR:DP7862	1/2"-20 DRAIN PLUG WITH MOLDED RUBBER WASHER..1 EACH	\$ 3.34
TMR:DP7725	12MM -1.75 DOG POINT DRAIN PLUG..1 EACH	\$ 0.58
TMR:DP7738X	12MM -1.25 DRAIN PLUG..1 EACH	\$ 0.82
TMR:DP8031	12MM -1.75 DRAIN PLUG..1 EACH	\$ 2.66
TMR:DP7860	12MM -1.75 DRAIN PLUG WITH RUBBER INSET GASKET..1 EACH	\$ 1.78
TMR:DP7868	12MM -1.75 DRAIN PLUG WITH RUBBER INSET GASKET & LARGE WASHER FACE..1 EACH	\$ 2.00
TMR:DP7701	14MM -1.5 REGULAR POINT DRAIN PLUG..1 EACH	\$ 1.02
TMR:DP7802	14MM -1.50 DOG POINT DRAIN PLUG..1 EACH	\$ 1.56
TMR:DP8026	14MM -1.50 DRAIN PLUG..1 EACH	\$ 2.93
TMR:DP7846	14MM -1.50 DRAIN PLUG..1 EACH	\$ 0.79
TMR:DP7855	14MM -1.25 DRAIN PLUG..1 EACH	\$ 0.73
TMR:DP8006	14MM -1.50 DRAIN PLUG WITH INSET RUBBER GASKET..1 EACH	\$ 4.06
TMR:DP8007	14MM -1.50 DRAIN PLUG WITH INSET RUBBER GASKET..1 EACH	\$ 4.06
TMR:DP7739X	16MM -1.50 REGULAR POINT DRAIN PLUG..1 EACH	\$ 0.86
TMR:DP7742	18MM -1.5 DRAIN PLUG..1 EACH	\$ 3.50

Drain Plug And Gasket Assortments

Large drain plug gasket assortment : 185 pieces, 28 gaskets.

TMR:DP700	LARGE DRAIN PLUG GASKET ASSORTMENT..185 PIECES / 28 GASKETS	\$ 42.83
-----------	---	----------

O.E. style drain plug assortment : 32 pieces, 12 drain plugs.

TMR:DP750	DRAIN PLUG ASSORTMENT..32 PIECES / 12 PLUGS	\$ 53.13
-----------	---	----------

Drain plug and gasket assortment : 162 pieces, 21 drain plugs and gaskets.

TMR:DP800	DRAIN PLUG & GASKET ASSORTMENT..162 PIECES / 11 GASKETS / 10 DRAIN PLUGS	\$ 49.32
-----------	--	----------

SMALL PART ASSORTMENTS

Headlight Adjusting Screw Assortment

Headlight adjusting screw assortment : 16 pieces / 3 sizes

TMR:OPK1	HEADLIGHT ADJUSTING SCREW ASSORTMENT..16 PIECES / 3 SCREWS	\$ 14.93
----------	--	----------

Vacuum Cap Assortment

Vacuum cap assortment : 90 pieces, 6 caps.

TMR:OPK12	VACUUM CAP ASSORTMENT..90 PIECES / 6 CAPS	\$ 11.93
-----------	---	----------

Vacuum Connectors, Tees, "Y" And "L" Assortment

Vacuum connectors, tees, "y" and "l" assortment : 51 pieces, 17 vacuum connectors, tees, "y" and "l"

TMR:OPK16	VACUUM CONNECTOR "T" "Y" & "L" ASSORTMENTS..51 PIECES / 17 CONNECTORS	\$ 18.73
-----------	---	----------

Woodruff Keys

PIC:348-0063	WOODRUFF KEY ASSORTMENT..20 SIZES..250 PIECES	\$ 61.87
--------------	---	----------

MONDAY-FRIDAY
8am-5pm a helpful
HUMAN voice will
always answer the
phone
(770)474-1286

Parker Brothers
gladly accepts
Visa, Mastercard
Discover &
American Express

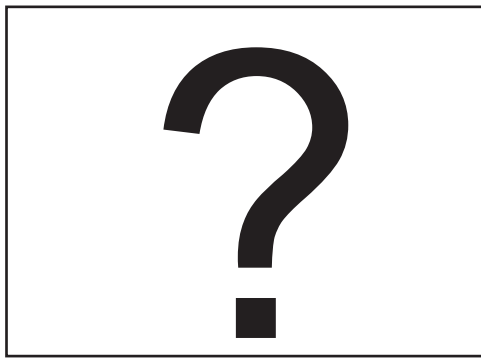

INDEX

PARKER BROTHERS, INC.

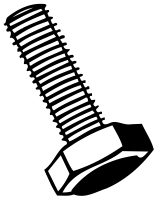

Mystik
The Ultimate
In Fine
Lubrication

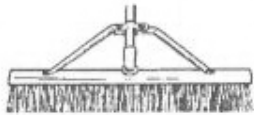
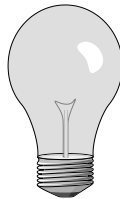
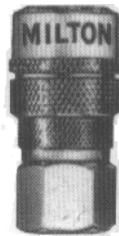

NATIONAL-SPENCER, INC.



Permatex





111	TRICHLOROETHANE	5-11
A...		
	ABSORBENTS	11-1, 11-2
	ACETONE	5-11
	ADHESIVES	
	REAR VIEW MIRROR	6-6
	REMOVER	6-6
	SPRAY	6-6
	TRIM	6-6
	WEATHERSTRIP	6-6
	ADHESIVES AND ABRASIVES	6-1... 6-12
	AIR	
	BLOW GUNS	8-7, 8-8
	COUPLERS	8-3... 8-7
	FILTERS	8-9
	FITTINGS	8-1... 8-3
	HOSES	8-1
	LUBRICATORS	8-10, 8-11
	REGULATORS	8-9, 8-10
	AIR COMPRESSOR OIL	1-15
	AIR CONDITIONING SUPPLIES	5-9
	AIR FRESHENERS	3-4, 4-3
	AIR HOSES AND FITTINGS	8-1... 8-14
	ALCOHOL	5-11
	ALIGNMENT SHIMS	7-9
	ALUMINUM CLEANER	4-2
	ANTIFREEZE	1-21
	PROTECTION CHART	1-23
	TESTER	13-2
	ANTI-SEIZE	5-2
	APRONS	11-5
	ASSORTMENTS	
	DRILL BITS	12-8, 12-9
	FUSES	10-4, 10-5
	NUTS AND BOLTS	12-4
	TERMINALS	10-7
	AUTO DETAIL SUPPLIES	4-1... 4-6
	AVIATION LUBRICANTS	1-16, 1-17
B...		
	BACK BRACES	11-4
	BALDWIN FILTERS	14-18, 14-19
	BANDING, METAL	12-9
	BAR AND CHAIN OIL	1-20
	BATTERY	
	CLEANER	5-7
	PROTECTOR	5-7
	AUTOMOTIVE	14-23
	CABLES	10-7
	FLASHLIGHT	12-7
	HOLDERS	10-7
	HYDROMETER	13-1
	LUGS	10-7
	TERMINALS	10-7
	TESTER	13-1
	BELT DRESSING	5-10
	BELTS	
	AUTOMOTIVE	14-21
	BOLTS	12-1, 12-2
	BONDO	5-10
	BOOSTER CABLES	13-1
	BOOTS, STEEL TOED	11-3
	BOTTLES, SPRAY	3-9
	BRAKE CLEANER	5-5
	BRAKE FLUID	1-22
	BROOMS	3-6

BRUSHES		
	CAR WASH	4-5
	SCRUBBING	3-8
	BUCKETS, EMPTY	4-4
	BUFFING PADS, CAR	4-3, 4-4
	BULBS	14-6... 14-8
	BUNG WRENCH, DRUM	9-13
C...		
	CABLE TIES	10-8
	CAN LINERS	2-3
	CAPS	
	FUEL	14-22
	OIL FILLER	14-22
	RADIATOR	14-22
	CAR WASH SOAP	4-1
	CARBURETOR CLEANER	
	DIP	5-3
	SPRAY	5-3
	CARPET CLEANERS	3-5
	CAULK	12-7
	CAUSTIC	5-11
	C-FOLD TOWELS	2-2
	CHAMOIS	4-4
	CHEMICALS	5-1... 5-11
	CHOP SAW BLADES	6-13
	CIRCUIT BREAKERS	10-3, 10-4
	CLEANING SUPPLIES	3-1... 3-9
	COFFEE CUPS	2-4
	COMPRESSION TESTER	13-2
	CONCRETE CLEANER	3-5
	CONES	11-6
	CONTACT CLEANER	5-6
	CONVOLUTED TUBING	10-9
	COTTER PINS	12-4
	COVERALLS	2-4
	CURRENT INDICATOR	13-1
	CUT-OFF WHEELS	6-12
D...		
	DEGREASER	3-5, 4-1
	DE-ICER	5-10
	DISC BRAKE QUIET	5-5
	DISINFECTANTS	3-3
	D-LIMONENE	5-11
	DOLLIES	9-13
	DRAIN PANS	9-9, 9-10
	DRESSINGS, TIRE	4-3
	DRILL BITS	12-9, 12-10
	DROP LIGHTS	13-1
	DRUM CRADLE	9-13
	DUST MASKS	11-4
	DUST PANS	3-6
E...		
	EAR PLUGS	11-5
	ELECTRICAL OIL	1-20
	ELECTRICAL SUPPLIES	10-1... 10-9
	ELECTRICAL TAPE	10-8
	ENAMEL REDUCER	5-11
	ENGINE TREATMENTS	5-8
	EPOXIES	6-5
	ETHYLENE GLYCOL	5-11
	EXHAUST REMOVER	4-2
	EXTENSION CORDS	13-1
	EYE WASH STATION	11-3
F...		
	FAUCET, DRUM	9-14



FILTERS	14-13... 14-19
FIRE EXTINGUISHERS	11-5
FIRST AID KITS	11-5
FLASHERS	14-1
FLASHLIGHTS	12-7
FLOOR MATS (PAPER)	2-4
FLUID MANAGEMENT	9-1... 9-14
FOOD GRADE LUBRICANTS	1-18
FORKS (PLASTIC)	2-4
FORM-A-SEAL	6-5
FORM-A-THREAD	6-5
FUEL INJECTION CLEANER	5-3
FUEL PUMP ACCESSORIES	12-10
FUEL PUMP HOSE	12-10
FUEL TREATMENTS	5-4
FUNNELS	
METAL	9-11
PAPER	2-4
PLASTIC	9-11, 9-12
SPECIALTY	9-12
TRANSMISSION	9-11
FUSES	10-1... 10-3
G...	
GARBAGE BAGS	2-3
GARBAGE CANS	12-10
GAS CANS	9-12
GAS TREATMENTS	5-4
GASKET MAKERS	6-1...6-3
GASKET REMOVER	
AEROSOL	6-3
CONDITIONING DISC	6-3
GATORADE	11-6
GEAR OIL	
AUTOMOTIVE	1-6,1-7
INDUSTRIAL	1-13... 1-15
GLASS BEADS	6-11
GLASS CLEANER	3-4
GLASSES, SAFETY	11-3
GLOVES	11-2, 11-32
GLUES	6-5
GOGGLES	11-3
GREASE	
GENERAL	1-8... 1-11
SPRAY	1-8, 5-2
TUNE-UP	5-10
GREASE FITTINGS	14-4...14-6
GREASE GUNS	9-5, 9-6
H...	
HAIR NETS	11-5
HAND CLEANERS	
ANTISEPTIC	3-2
DISPENSERS	3-3
HEAVY DUTY	3-1
LIGHT DUTY	3-2
WIPES	3-2, 12-12
HAND TOWELS	
C-FOLD	2-2
MULTI-FOLD	2-2
ROLL	2-1, 2-2
SINGLE-FOLD	2-2
HANDLES	3-9, 4-6
HARD HATS	11-5
HARDWARE	12-1... 12-11
HEAT SHRINK TUBING	10-8
HEAT TRANSFER OIL	1-20

HITCH BALLS	12-8
HOSE	
CLAMPS	14-1
FUEL	14-20
FUEL INJECTION	14-20
HEATER	14-20
MULTI-PURPOSE	14-20
VACUUM	14-20
HYDRAULIC FLUID	1-11... 1-13
I...	
ICE MELT	12-10
INSECT REPELLANT	12-9
INTERIOR CLEANER, AUTO	4-2
J...	
JUMPER CABLES	13-1
K...	
KEROSENE	5-11
KLEENEX	2-1
L...	
LACQUER THINNER	5-11
LADDERS	SEE SALES REP
LIGHT BULBS	12-7
LIQUID WRENCH	5-1
LOCK LUBES	5-10
LUBRICANTS	1-1... 1-24
LUBRICANTS, SPRAY	5-1, 5-2
M...	
MARINE LUBRICANTS	1-17
MARKERS	12-10
MASKING PAPER	2-4
METAL WORKING COMPOUNDS	5-10
METAL WORKING FLUID	1-19
METHYL ETHYL KETONE	5-11
MINERAL SPIRITS	5-11
MOP BUCKET	3-7
MOPS	
DUST	3-7
REGULAR	3-7
MOTOR OIL	
API CATEGORIES	1-23
HEAVY DUTY	1-2... 1-4
HI PERFORMANCE	1-5
INDUSTRIAL	1-5
PASSENGER CAR	1-1
SYNTHETIC	1-4
VISCOSITY EQUIVALENTS	1-24
MUFFLER REPAIR	6-5
MULTI-FOLD TOWELS	2-2
MULTI-PURPOSE CLEANER	3-3, 4-1
N...	
NAPKINS	2-4
NOZZLE-FUEL	12-10
NOZZLES, WATER	4-4
NUTS	12-2, 12-3
O...	
OIL ANALYSIS	1-22
OIL CANS	9-10, 9-11
OIL FILTER WRENCH	13-2
P...	
PAINT	
BRUSHES	12-5
SPRAY	12-5, 12-6
PAPER DISPENSERS	2-3
PAPER PLATES	2-4
PAPER PRODUCTS	2-1... 2-4



PAPER TOWELS	2-1
PARTS	14-1... 14-25
PARTS WASHING FLUID	5-6
PB BLASTER	5-1
PENETRANTS, SPRAY	5-1
PIPE SEALANT	6-4, 6-5
POLISH	
CAR	4-3
FURNITURE	3-3
POST IT NOTES	2-4
POWER STEERING FLUID	1-21
PRIMER	12-5
PROPYLENE GLYCOL	5-11
PROTECTIVE CLOTHING	2-4
PUMPS	
CHEMICALS	9-1,9-2
FUEL	9-2,9-3
GREASE	9-6, 9-7
GREASE ACCESSORIES	9-8, 9-9
OIL	9.3... 9-5
R...	
RADIATOR, SEALER/FLUSH	5-7, 5-8
RAGS	3-7
RAIN SUITS	11-4
RAZOR BLADES	13-2
ROLL TOWELS	2-1, 2-2
RUBBER COATING	5-10
RUBBING COMPOUNDS	4-3, 4-4
RUST INHIBITOR	5-10
S...	
SAFETY SUPPLIES	11-1... 11-6
SAND PAPER	
DA PAPER	6-9
FILE	6-10
ROLLS	6-10
SHEETS	6-9
SCOTCH BRITE PADS	6-112
SEALANTS	
BODY	6-7
GASKET	6-1, 6-2
PIPE	6-4,6-5
SEAT COVERS (PLASTIC)	2-4
SERVICE STATION SUPPLIES	12-10, 12-11
SHOP TOOLS	13-1... 13-3
SHRINK WRAP	6-9
SINGLE-FOLD TOWELS	2-2
SOAP	
CAR WASH	4-1
HAND	3-1, 3-2
SODA ASH	5-11
SPARK PLUGS	14-9... 14-13
SPILL KITS	11-2
SPINDLE OIL	1-19
SPOONS (PLASTIC)	2-4
SPRAY BOTTLES	3-9
SPRAYERS	12-9
SPRAY-NINE	3-3
SQUEEGEES	
FLOOR	3-8
WINDOW	3-8
WINDSHIELD	12-11
STARTING FLUID	5-6
STRAPS	12-9
STYROFOAM CUPS	2-4
SUCTION GUN	9-3

SWEEPING COMPOUND	3-5
T...	
TAPE	6-8,6-9
TARPS	12-9
TERMINALS, ELECTRICAL	10-6
TEST LIGHT	13-1
THERMOSTATS	14-22
THREAD LOCKERS	6-3, 6-4
TIRE	
AIR CHUCKS	7-6
CAPS	7-4
CLEANER	4-2
CORES	7-3
CRAYONS	7-8
MOUNTING COMPOUND	7-8
PRESSURE GAUGES	7-6, 7-7
VALVE TOOLS	7-5
VALVES	7-4,7-5
TIRE REPAIR	
ACCESSORIES	7-1, 7-2
FIX-A-FLAT	7-8
PATCHES	7-1
PLUGS	7-2
TIRE SUPPLIES	7-1... 7-11
TISSUE	2-1
TOILET BOWL PRODUCTS	3-5
TOILET PAPER	2-1
TOILET SEAT PROTECTORS	2-1
TOOL OIL	1-19, 5-10
TOULENE	5-11
TRANSMISSION ADDITIVES	5-8
TRANSMISSION FLUID	1-5, 1-6
TRANS-HYDRAULIC FLUID	1-11,1-12
TRASH BAGS	2-3
TRASH CANS	12-10
TURBINE OIL	1-16
TWO-CYCLE OIL	1-17,1-18
U...	
URINAL SCREENS	3-5
V...	
VAT STRIPPER	5-6
VESTS	11-5
W...	
WASHERS	12-3, 12-4
WATER HOSES	4-4
WAX	
CAR	4-3
FLOOR	3-5
WAX STRIPPER	3-5
WAY OIL	1-19
WD-40	5-1
WEED KILLER	12-9
WHEEL CHAULKS	12-8
WHEEL CLEANER	4-2
WHEEL WEIGHTS	7-9... 7-11
WINDOW TREATMENTS	4-2
WINDSHIELD WASHER SOLVENT	5-7
WINDSHIELD WIPERS	14-2... 14-4
WIPERS	
CLOTH	3-7
PAPER	2-2
WIRE	10-5
WIRE MARKERS	10-10
WIRE TIES	10-8
X...	



XYLENE	5-11
Z...	
ZIP TIES	10-8

**STATE OF GEORGIA
DEPARTMENT OF REVENUE
SALES AND USE TAX CERTIFICATE OF EXEMPTION
GEORGIA PURCHASER OR DEALER
EFFECTIVE JULY 1, 2000**

To: _____
(SUPPLIER)

(DATE)

(ADDRESS)

THE UNDERSIGNED HEREBY CERTIFIES that all tangible personal property purchased or leased after this date will be for the purpose indicated below, unless otherwise specified on a particular order, and that this certificate shall remain in effect until revoked in writing. Any tangible personal property obtained under this certificate of exemption is subject to the sales and use tax if it is used or consumed by the purchaser

in any manner other than indicated on this certificate.

(Check proper box.)

1. Resale, rental or leased only, including but not limited to the purchase for resale of gasoline and other motor fuels.

2. Materials for further processing, manufacture or conversion into articles of tangible personal property for resale which will become a component part of the property for sale, or be coated upon or impregnated into the product at any stage of its processing, manufacture or conversion and nonreturnable materials used for packaging tangible personal property for shipment or sale. Containers or other packaging materials purchased for reuse are not exempt.

3. Machinery used directly in the manufacture of tangible personal property for sale purchased as additional, replacement or upgrade machinery to be placed into an existing plant in this State.

4. Direct Pay Permit authorized under Regulation 560-12-1-.16. The holder of a Direct Pay Permit must pay the 3% Second Motor Fuel Tax to suppliers on purchases of gasoline.

5. For use by Federal Government, State Government, any county, municipality or public school system of this State, when supported by official purchase orders or for use by Hospital Authorities created by Article 4, Chapter 7, of Title 7, and County or City Housing Authorities created by Article 1, Chapter 3 of Title 8. The State of Georgia, counties, municipalities, public schools, Hospital and Housing Authorities of Georgia must pay the 3% Second Motor Fuel Tax to suppliers.

A Georgia Sales and Use Tax Certificate of Registration Number is not required for this exemption.

6. Aircraft, watercraft, motor vehicles and other transportation equipment manufactured or assembled, sold and delivered by the manufacturer or assembler for use exclusively outside this State, or delivery of the crafts is for the sole purpose of removing same under its own power when it does not lend itself more reasonably to removal by other means.

A Georgia Sales and Use Tax Certificate of Registration Number is not required for this exemption.

7. Aircraft, watercraft, railroad locomotives and rolling stock, motor vehicles and major components of each, which will be used principally to cross the borders of this State in the service of transporting passengers or cargo by common carriers and by carriers who hold common carrier and contract carrier authority in interstate or foreign commerce under authority granted by the United States government. Replacement parts installed by carriers in such craft or vehicles which become an integral part of the craft or vehicle are likewise exempt. Private and contract carriers are not exempt.

(TYPE OF BUSINESS ENGAGED IN BY THE PURCHASER)

(COMMODITY CODE)

I declare, under penalties of false swearing, that this certificate has been examined by me and to the best of my knowledge and belief is true and correct, made in good faith, pursuant to the sales and use tax laws of the State of Georgia.

(PURCHASER'S FIRM NAME)

(CERTIFICATE OF REGISTRATION NO.)

(ADDRESS)

By _____

(SIGNATURE)

Title _____

(OWNER, PARTNER, OFFICIAL)

A supplier is required to have only one certificate of exemption form on file from each purchaser buying tax exempt. The supplier must exercise ordinary care to determine that the tangible personal property obtained under this certificate is for the purpose indicated. Suppliers failing to exercise such care will be held liable for the sales tax due on such purchases. For example, a supplier cannot accept a Certificate of Registration number bearing a "214" prefix since these are issued to a Contractor which has been deemed to be the consumer and is required to pay the tax at the time of purchase.

Parker Brothers, Inc.

OILS/LUBRICANTS/SERVICE STATION/AUTOMOTIVE
COMMERCIAL/INDUSTRIAL/MANUFACTURING SUPPLIES

4450 WEST PANOLA RD

ELLENWOOD, GA 30294

PHONE:770-474-1286 FAX:770-474-2750

CREDIT APPLICATION & AGREEMENT

An open account is offered to credit worthy customers as a convenience in paying for their purchases. It is not intended to be an extension credit for long periods. The followings is submitted for opening such an account with Parker Brothers, Inc.

Legal Company Name: _____

Billing Address: _____

Shipping Address: _____

Phone: _____ Fax: _____

Type of Business: _____ How long in Business: _____

Add Sales Tax @ _____% or Attach Certificate for Sales Tax Exempt # _____

Principles: list Owner(s), Partner(s), and Officer(s)

Name: _____ Position: _____

Name: _____ Position: _____

CREDIT REFERENCES: (Give complete company name, address, phone number, and fax number)

1. Name: _____

Address: _____

2. Name: _____

Address: _____

Phone: _____ Fax: _____

3. Name: _____

Address: _____

Phone: _____ Fax: _____

4. Name: _____

Address: _____

Phone: _____ Fax: _____

Parker Brothers, Inc.

OILS/LUBRICANTS/SERVICE STATION/AUTOMOTIVE
COMMERCIAL/INDUSTRIAL/MANUFACTURING SUPPLIES
4450 WEST PANOLA RD
ELLENWOOD, GA 30294

PHONE:770-474-1286 FAX:770-474-2750

CREDIT APPLICATION & AGREEMENT

Bank Name: _____

Phone: _____ Fax: _____

Account #: _____ Type of Account: _____

Address: _____

IF THIS APPLICATION FOR AN ACCOUNT IS APPROVED BY PARKER BROTHERS, INC. WE AGREE TO OBSERVE PARKER BROTHERS TERMS WHICH WE UNDERSTAND TO BE AS FOLLOWS:
WE AGREE TO PAY ALL PURCHASES WITHIN TEN (10) DAYS OF DATE OF PURCHASE. ALSO, IF IT BECOMES NECESSARY TO EFFECT COLLECTIONS, WE AGREE TO PAY THE ACTUAL AMOUNT OF OUR BILL, PLUS INTREST AND ALLOWABLE COURT COST. A LATE CHARGE WILL BE ADDED TO ALL PAST DUE INVOICE AT A RATE OF 2% PER MONTH.

Print Name: _____ Print Name: _____

Signature: _____ Signature: _____

Title: _____ Title: _____

Date: _____ Date: _____

PARKER, BROTHERS, INC.

Oils / Lubricants / Service Station / Automotive
Commercial / Industrial / Manufacturing Supplies
4450 West Panola Road
Ellenwood, Georgia 30294-2799

Order Desk (770) 474-1286

Fax (770) 474-2750

TERMS

All new accounts C.O.D. until a credit application has been filled out and approved by our Credit Manager. All approved credit applications are net 10 days (*) and are payable from invoice date. No statement will be mailed. A Service Finance Charge of 2% will be added to invoices outstanding at closing of our books at the end of the month following month of purchase.

(*) This applies to accounts with approved Credit Applications on file and valid account numbers. Credit Applications are available from our salesmen. For Sales Exemption, we must have a state Sales Tax Exemption Certificate on file.

Lease and Finance Plans on equipment are available contact us.

QUANTITY DISCOUNTS

Oils and anti-freeze are discounted by quantity ordered. See our quantity discount schedule for details. Our sales personnel will be happy to assist you when ordering and explain combining of some items to obtain further discounts. Some manufacturers offer extra discounts on direct truckload shipments.

RETURN POLICY

A 20% re-stocking charge on all returns of new unopened merchandise. Returns must have prior approval. Original sales invoice number and date should accompany all requests. We reserve the right to refuse any returns of merchandise due to age, obsolescence, or unsalable condition. (No returns on special ordered merchandise are accepted.) Not to exceed 2% of previous year's purchase.

DAMAGED, LOST OR SHORT SHIPMENTS

WAREHOUSE PICK-UP ORDER AND OUR DELIVERY TRUCKS

All delivery receipts should be checked against merchandise received prior to signing of tickets. Note any discrepancies on delivery receipt.

UNITED PARCEL SERVICE SHIPMENTS

If UPS shipments are not received in good order, report damage to local UPS office immediately giving full particulars.

FREIGHT SHIPMENTS BY RAIL OR TRUCK

The items in shipments were packed in accordance with the rules and packing specifications set forth in the Railroad and National Consolidated Freight Classifications, and have been receipted for the original carrier in good condition.

If shipment is not delivered to you in good order and in accordance with quantity shown on Bill of Lading, have the shortage or damage noted by the delivering carrier's Freight Agent on both receipts and expense bill. If you accept shipment from Transportation Companies, short of what is enumerated on the Bill of Lading or damaged, without having proper notation by the delivering carriers agent, you do so at your own risk.

If boxes or crates are in apparent good condition, but upon opening contents are found to be damaged, call delivering carrier's Freight Agent or adjust to view same and have him make a bad order report on the freight bill relative to such concealed damage. Claims for Loss or Damage on shipment must not be deducted from our invoice, nor payment of the invoice withheld awaiting adjustments of such claims, as we do not guarantee safe delivery. We will not accept return of any materials unless permission to do so has been given by us in writing.

WARRANTIES AND ADJUSTMENTS

Parker Brothers, Inc. does not warrant merchandise. Any warranties on the products sold by Parker Brothers, Inc. are those made by the manufacturers. Parker Brothers, Inc. is not responsible for transportation from the customer to the Warranty Repair Store. Parker Brothers, Inc. hereby disclaims all warranties, either express or implied, including any implied warranties of merchantability of fitness for a particular purpose. Parker Brothers, Inc. neither assumes nor authorizes any person to assume for it any liability in connection with the sale of said products. We will, however do everything we can to assist you, our customer, in obtaining proper credit on defective items and will pass on full whatever credit is granted by the manufacturer on such items.

Prices are subject to change without notice.

THIS CATALOG IS A BUYER'S GUIDE AND SHOULD NOT BE USED AS AN APPLICATION CHART.

PARKER, BROTHERS, INC.

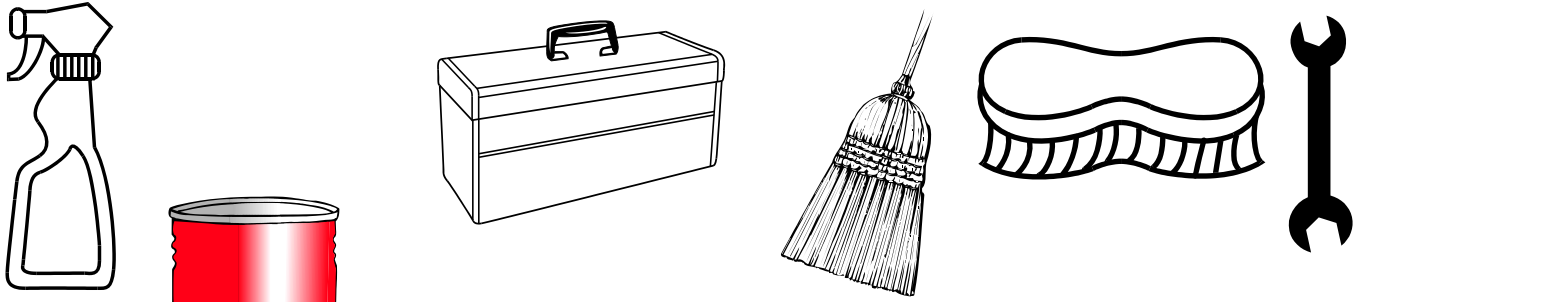

PHONE 770-474-1286
FAX 770-474-2750

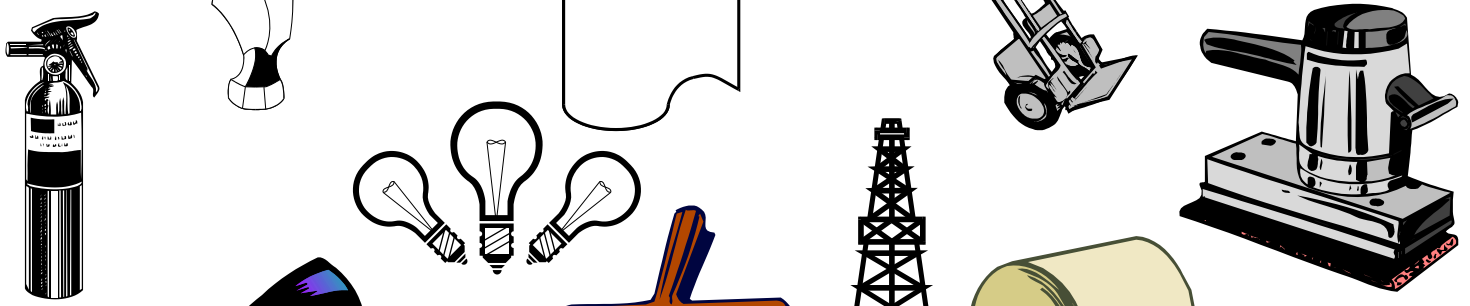

WE DELIVER

DOCK PICK-UP

PARKER, BROTHERS, INC.
OILS/LUBRICANTS/SERVICE STATION/ AUTOMOTIVE
COMMERCIAL/INDUSTRIAL/MANUFACTURING
SUPPLIES

4450 WEST PANOLA RD
ELLENWOOD, GA 30294-2799
PHONE 770-474-1286 FAX 770-474-2750

Bulk Rate
U.S. Postage
PAID
Permit No.15
Ellenwood, GA 30294

